

ELECTRONIC INDUSTRIES

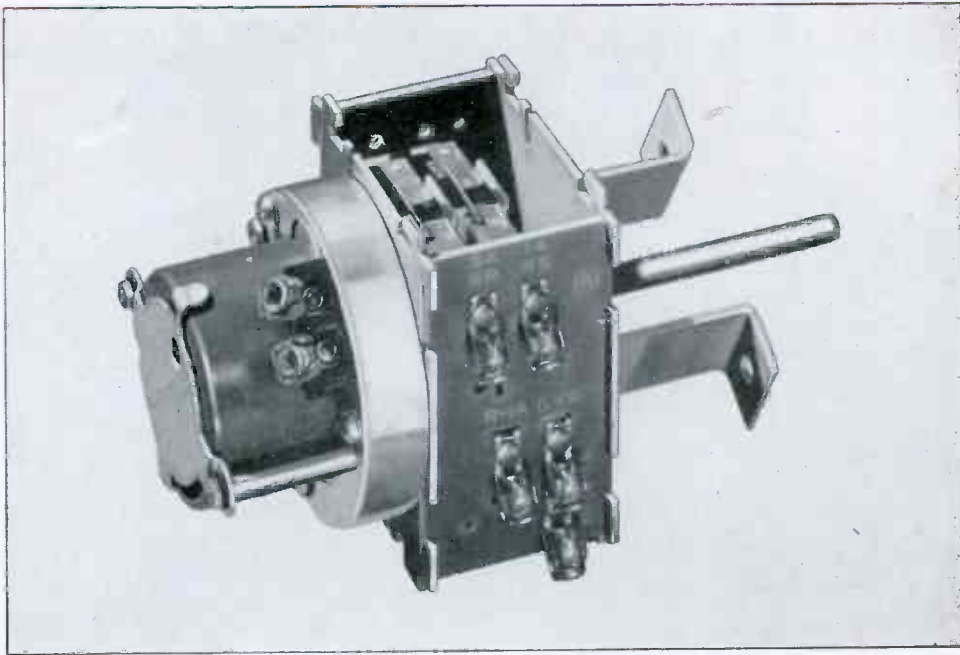

1945
APRIL
Caldwell-Clements, Inc.

Brains of Your Postwar Product— a Mallory Interval Time Switch



HERE'S a precision part—developed by Mallory for controlling automatic home laundry equipment, washing machines and dryers—that seems almost human. Controlled by a Mallory Interval Time Switch, a piece of electrical or electronic equipment performs a pre-determined sequence of operations automatically. Simply set a dial, and the machine's "thinking" is done for it by the Mallory switch.

Construction of the time switch is typical of the *precision workmanship* for which Mallory is noted. The small sturdy motor is sealed in oil—requires no lubrication. Precision springs assure smooth mechanical operation, and contacts of a special Mallory alloy have uniformly low electrical resistance. The entire switch is ruggedly built for dependability and long life.

Manufacturers of industrial, electrical and electronic equipment . . . seeking greater operating efficiency and output . . . will find many uses for the Mallory Interval Time Switch, as have makers of household appliances. The postwar trend to automatic operation is evident.

Now is the time to discover how *you* can incorporate the "brains" of this switch in your postwar products—for the greater efficiency that assures greater sales appeal. Consult Mallory while your designs are being planned.

P. R. MALLORY & CO., Inc., INDIANAPOLIS 6, INDIANA



P. R. MALLORY & CO. Inc.
MALLORY



Industrial and Electronic Switches

ELECTRONIC INDUSTRIES

Including INDUSTRIAL ELECTRONICS

★ IN THIS ISSUE

APRIL, 1945 ★

FRONT COVER—Repeater Amplifier for Coaxials	See Page 4
EDITORIAL	75
DESIGNING FILTERS FOR SPECIFIC JOBS—Arthur H. Halloran	76
THE VIBRATRON	79
WIRE FOOTAGE COUNTER	81
OWI-CBS 200 KW WEST COAST TRANSMITTER—Robert N. DeHart	82
MODERN LABORATORY SETUP	86
ALLOCATIONS NEARER	88
INTERFERENCE PROBLEMS—John H. Bose	91
MULTI-CHANNEL SOUND RECORDING ON FILM	92
ELECTRONIC TRAINER	94
RCA REVEALS PROJECTION TELE	95
THERMAL STABILITY IN RECEIVER OSCILLATORS—Ralph R. Batcher	96
REPEATER AMPLIFIER	98
ELECTRONIC RECORDER FOR FLIGHT TESTING—Thomas A. Dickinson	100
NINE PRODUCTION LINE SHORTCUTS	102
CAVITY RESONATORS—W. Daellenbach	104
DC PICTURE TRANSFER—Henry N. Kozanowski	106
NAVY RADIO EQUIPMENT	108
TUBES ON THE JOB	110
Association News	111
Survey of Wide Reading	112
What's New	114
Washington News	118
New Patents Issued	120
Television Today	122
New Books	198
New Bulletins	200

ORESTES H. CALDWELL, Editor

M. CLEMENTS, Publisher

EDITORIAL STAFF—Ralph R. Batcher, consulting editor; Stanley P. McMinn, managing editor; William Moulic, electronic theory and design; Josepha Zentner, Ph.D., patents and foreign reviews; H. L. M. Capron, engineering management relations; E. T. Bennett, editorial records; Charles Dreyer, art director; Carl Buhrer, circuit diagrams; Roland C. Davies, 1290 National Press Building, Washington, D. C., Washington editor; Arthur H. Halloran, 1020 Union St., San Francisco, west coast editor.

READER SERVICE—J. Cosin, H. Mirtel; data research, H. Kulik.

CIRCULATION—B. V. Spinetta, circulation director; Subscriptions; list compilation: B. Gollub, M. Groening, B. Ruchaisky.

BUSINESS—M. H. Newton, business manager; John Samborn, eastern manager; Richard Fitzpatrick, western manager; O. H. Sutter, New England Manager; Lee Robinson, district manager; Ben Morris, research; N. McAllister, production manager; J. E. Cochran, make-up; E. P. Butler; W. W. Swigert, credit manager; W. Kenneth Reynolds, D. Williams, E. Callahan.

CHICAGO MANAGER—R. Y. Fitzpatrick, 201 N. Wells Street. Tel. RAN 9225.

Electronic Industries, April, 1945. Vol. IV, No. 4. Regular price per copy 35 cents. Published monthly by Caldwell-Clements, Inc., 480 Lexington Avenue, New York, N. Y. M. Clements, President; Orestes H. Caldwell, Treasurer; M. B. Clements, Assistant Secretary. Subscriptions: United States and possessions, Mexico, Central and South American countries, \$3.00 for one year; \$5.00 for two years; \$6.50 for three years. Canada, \$3.50 per year; \$5.50 for two years; \$7.15 for three years. All other countries \$5.00 a year. Entered as Second Class Matter, September 20, 1943, at the Post Office at New York, N. Y., under the act of March 2, 1879. Copyright by Caldwell-Clements, Inc., 1945. Printed in U. S. A.

CALDWELL-CLEMENTS, INC.—TEL. PLAZA 3-1340—480 LEXINGTON AVENUE, NEW YORK 17, N. Y.



WHY AMPEREX

WATER AND AIR COOLED
TRANSMITTING AND RECTIFYING TUBES

233

Another new **AMPEREX**
power tube for induction and
dielectric heating equipment

The new **Amperex 233** is designed for use as a Class C oscillator or amplifier for generating radio frequency power at frequencies up to 30 megacycles. Two grid arms make neutralization more convenient in the amplifier connection, and also permit cooler operation of the grid when the tube is employed at higher frequencies either in a self-excited oscillator or power amplifier. As do all tubes designed and developed in our laboratory, the 233 incorporates well-known "Amperextras" which make for longer operating efficiency and lower operating costs. **Write for engineering data.**



AMPEREX ELECTRONIC CORPORATION

79 WASHINGTON STREET • • • • • BROOKLYN 1, N. Y.
Export Division: 13 E. 40th St., New York 16, N. Y., Cables: "Arlab"

GIVE WHAT YOU'VE GOT . . . DONATE A PINT OF BLOOD TO THE RED CROSS

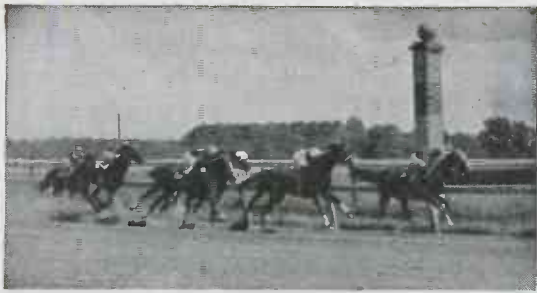

AWAY AHEAD!



Tobe Leads the Noise Elimination Field

FEW problems are as vexing as the elimination of unwanted radio interference set up by the operation of nearby electric motors. And few sources of engineering advice on this subject are as experienced as the Tobe Engineering Staff. *Tobe is the acknowledged leader in this field;* our organization has devoted 17 years to the intricate problems of noise elimination.

The large #1182 Navy-Type Filter illustrated above is an example of our specialization. Examine the curve and container dimensions. This is only one of a large number of filters designed to meet special needs. Send for complete details. Let us help you solve any problem connected with blotting out unwanted "man-made" radio static. Your inquiries are welcome.

TOBE DEUTSCHMANN CORP., CANTON, MASS.

GRAND CENTRAL TERMINAL BUILDING
NEW YORK 17, N. Y.

110 WEST BROADWAY
GLENDALE 4, CAL.

230 NORTH MICHIGAN AVE.
CHICAGO 1, ILL.

2-159 GENERAL MOTORS BLDG.
DETROIT 2, MICH.

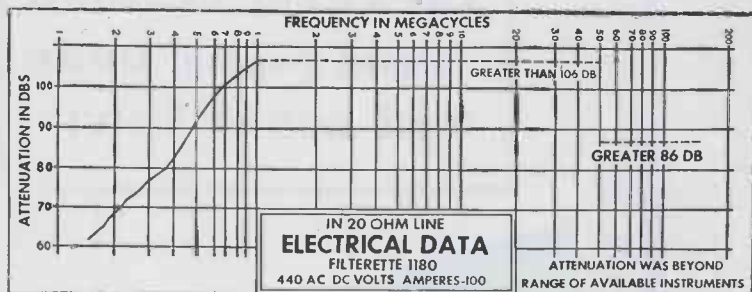

TYPE 1182—ATTENUATION RANGE
150 KC to 150 MC

CONTAINER DIMENSIONS

Length . . . 22 1/8" Height . . . 4 1/8"
Width . . . 11 7/8"

This unit contains three #1180 Filterettes,
each bearing Navy-Type No. CTD 53177.

The tiny amplifier illustrated on the cover is a special type of Western Electric unit developed for coaxial cable transmission of telephone, radio and television signals. The whole unit measures but 5½ in. square and 7 in. high and during manufacture is hermetically sealed. Amplifiers like this one operate unattended on lines as long as 4,000 miles where there may be as many as 800 amplifiers in tandem. See page 98.

Through an unfortunate oversight, no mention was made in the March issue of the fact that the Kodachrome transparency from which the cover illustration for that issue was made, was produced especially for "Electronic Industries" in the laboratories of the North American Philips Co., by one of their color photographers.

**Arthur Halloran
EI Pacific Editor**

Arthur H. Halloran, well-known radio figure of the Pacific Coast, has been appointed Western Editor of "Electronic Industries." Mr. Halloran was for many years editor and publisher of the magazine "Radio," and previously had served as vice-president and managing editor of the "Journal of Electricity" published in San Francisco.

In recent years he has specialized in research on cathode-ray equipment and television. He was chief of electrical exhibits for the Golden Gate Electrical Exposition of 1937, and is the author of the book "Television with Cathode Rays," besides making numerous contributions to radio journals.

During the war period he has served as U. S. Signal Corps pre-radar instructor at the University of California, Berkeley, and for the past 18 months has been research associate in ultra-high-frequencies at the Harvard University Radio Research Laboratory, Cambridge, Mass., directed by Dr. Frederick E. Torman. Mr. Halloran is a graduate of the University of California, class of 1904. His permanent address is 1020 Union Street, San Francisco, Calif.

Electronic Frankfurters

Wiener vending machine, that operates when a proper coin is put into a slot, delivers a hot frankfurter-bun sandwich wrapped in a paper napkin with the meat cooked electrically a moment after the coin is deposited. The electric cooker includes a high-voltage, high-frequency diathermy coil.



**IT'S THE LAST PUSH
THAT COUNTS**

*and it's often
the hardest.*

**LET'S KEEP PUSHING
. . . and buying MORE
WAR BONDS NOW!**

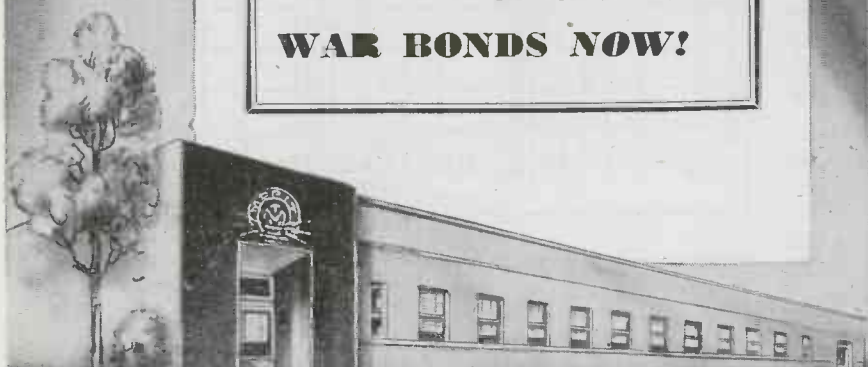

MERIT COIL & TRANSFORMER CORP.

TELEPHONE
4427 North Clark St. Long Beach 5311 CHICAGO 40, ILL.

G-E all-metal THYRATRON

Husky

for day-in, day-out service where high currents are employed.

Responsive

to low-power grid actuation, owing to the control-and-shield-grid design.

Versatile

in its wide range of industrial uses—for motor, welding, temperature and other controls, and as a grid-controlled current rectifier.



This rugged G-E thyatron is a tube you can count on for reliable performance in your plant. Its metal envelope not only makes Type FG-172 shock-resistant, but fits the tube ideally for panel-mounting. Mercury vapor is used in this tube, and in conjunction with the all-metal construction permits passage of high currents efficiently and for substantial periods.

● The 4-electrode—control-and-shield-grid—design gives a high de-

gree of sensitivity, enabling current-flow to be started where available grid power is small or the grid is actuated from a high-impedance source.

● Consult your nearest G-E office or distributor for full ratings, performance charts, and other information on the FG-172 thyatron or other types in G.E.'s complete line of industrial electronic tubes. Or write to *Electronics Department, General Electric, Schenectady 5, New York.*

There Are 265 G-E and Graybar Main Supply Outlets for G-E Electronic Tubes, Backed Up by Centrally Located Stocks in 26 Large Cities from Coast to Coast.

TYPE FG-172, PRICE \$35.

Hot-cathode, mercury-vapor thyatron with control and shield grids. All-metal construction, convection-cooled. Ratings for motor control service (including other industrial controls except welding) and welding control service are:

	Motor Control	Welding Control
Cathode voltage	5.0 v	5.5 v
Cathode current	10.0 amp	11.0 amp
Anode peak voltage	2,000 v	750 v
Anode peak current	40 amp	77 amp
Anode average current	6.4 amp	2.5 amp

Hear the G-E radio programs: "The World Today" news, Monday through Friday, 6:45 p. m., EWT, CBS. "The G-E All-Girl Orchestra," Sunday 10 p. m., EWT, NBC. "The G-E House Party," Monday through Friday, 4 p. m., EWT, CBS.

GENERAL  ELECTRIC

162-D7-8850

PLANE-O-SCOPE

THE FLAT-FACE TELEVISION TUBE

INVENTED BY PHILCO

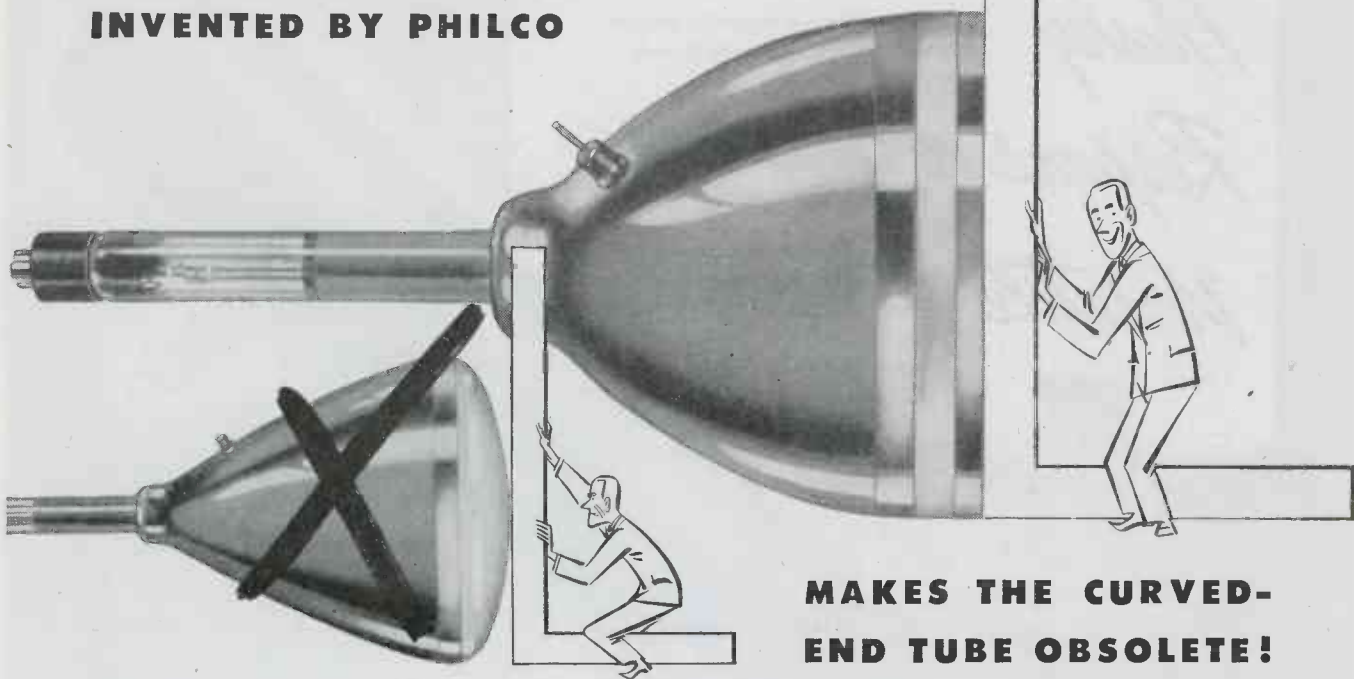

**MAKES THE CURVED-
END TUBE OBSOLETE!**

Another Philco contribution to better television pictures is the Plane-O-Scope. Developed in the Philco laboratories, it is a flat-face picture tube that does away with the limitations of a curved viewing surface. With the Philco Plane-O-Scope, clear and undistorted pictures may be seen at any angle . . . from the sides as well as the front of the screen. Since the face is flat, its entire area is usable, giving a 10" Plane-O-Scope as much

effective surface as a 12" curved-face tube. Furthermore, the Plane-O-Scope reduces stray light reflection . . . giving you a brighter picture, with better contrast.

Here's another example of how Philco has pioneered in electronic research, creating the basis on which it is making vital contributions today to radar and the electronic miracles of modern warfare.

PHILCO

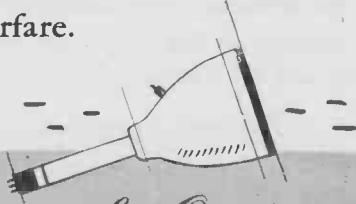

*Famous for Quality
the World Over*

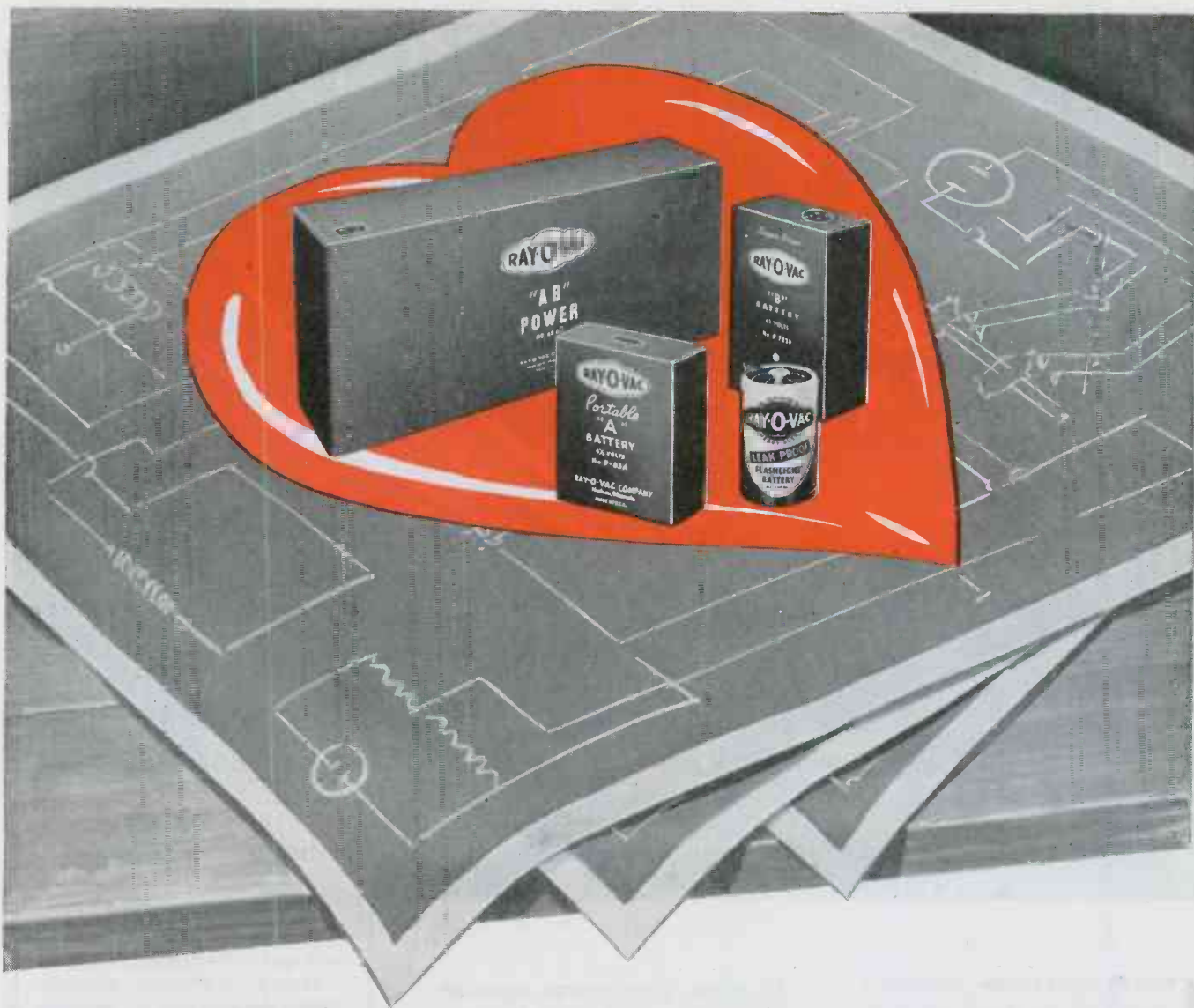

Here's the very heart of your post-war product!

When your new product gets into the consumer's hands, the battery that powers it can spell the difference between consumer satisfaction and disappointment. Ray-O-Vac Batteries are designed and built to deliver plus performance—extra capacity and dependability at lowest possible cost to the user. You take no chances

when you specify Ray-O-Vac Batteries. Our engineers are at your service now.

For Dependable Power, Use

RAY-O-VAC BATTERIES

RAY-O-VAC CO., MADISON 4, WIS.

OTHER FACTORIES AT CLINTON, MASS., LANCASTER, OHIO, SIOUX CITY, IOWA, FOND DU LAC, WIS., MILWAUKEE, WIS.

ELECTRONIC INDUSTRIES • April, 1945

TOWARD THE FUTURE—

Ankoseal CABLES



Why ANKOSEAL solves cable problems

Ankoseal, a thermoplastic insulation, can help solve many electrical engineering problems, now and in the future. *Polyvinyl* Ankoseal possesses notable flame-retarding and oil resisting characteristics; is highly resistant to acids, alkalis, sunlight, moisture, and most solvents. Polyethylene Ankoseal is outstanding for its low dielectric loss in high-frequency transmission. Both have many uses, particularly in the radio and audio fields. Ankoseal cables are the result of extensive laboratory research at Ansonia—the same laboratories apply engineering technique in the solution of cable problems of all types.

COMMUNICATION—WITHOUT—WIRES—the keynote of the nation's ability to wage modern war—has brought in its train a great paradox: A need for *more and different cables*. And the same needs will extend into the post-war world.

In the solution of the current problems that this need has raised, we at Ansonia, in all modesty, have played no small part. Ankoseal polyvinyl and polyethylene cables have been designed to meet the particular needs of our Army and Navy—needs which, of course, must remain secret, but which involve using *engineering techniques* in the solution of the problems they present.

To other government agencies requiring "fussy" cable jobs, Ansonia offers the "Yankee ingenuity" which has enabled this organization to meet these requirements—accurately and on time. And to business men now and in the post-war world, Ansonia, through its Ankoseal thermoplastic cables, offers the same ability to meet similar problems to their satisfaction.

THE ANSONIA ELECTRICAL COMPANY

Specializing in "Ankoseal" a Thermoplastic Insulation
ANSONIA • CONNECTICUT



A Wholly-Owned Subsidiary of

NOMA ELECTRIC CORPORATION

GENERAL OFFICES • NEW YORK, N. Y.

—In peacetime makers of the famous Noma Lights—the greatest name in decorative lighting. Now, manufacturers of fixed mica dielectric capacitors and other radio, radar and electronic equipment.

Cavalcade of Coaxial Connectors

CABLE PLUG

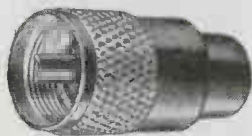

Connector #50.399-1
Signal Corps #PL-259

Signal Corps design. Mates to receptacle #50.392-1. Insulation is low-loss, mica-filled bakelite. Metal parts of silver-plated brass.

CABLE PLUG



Connector #50.393
Signal Corps #PL-259A
Navy Part #CI-49195

Navy designed. Mates with receptacle #50.392-1. Low-loss, mica-filled bakelite insulation. Metal parts of brass, silver-plated.

RIGHT ANGLE PLUG ADAPTER



Connector #50.394-1
Signal Corps #M-359
Navy Part #CI-49192

Elbow adapter for changing direction of wiring. Housing of die-cast zinc, silver-plated. Pin and socket silver-plated spring brass. Insulation is polystyrene.

SHIELDING HOOD

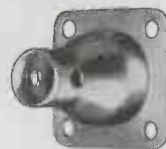

Connector #47.447
Signal Corps #M-360
Navy Part #CI-49193

Silver-plated brass hood, used with plug #50.392-1 as a shield for the wiring cable. Holes provided for soldering to cable shield.

CHASSIS RECEPTACLE

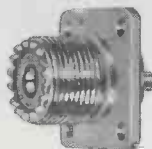

Connector #50.392-1
Signal Corps #SO-239
Navy Part #CI-49194

Flanged receptacle for chassis mounting. Housing is die-cast zinc, silver-plated. Low-loss, mica-filled bakelite insulation. Socket contact of silver-plated copper alloy.

CONNECTOR ADAPTER

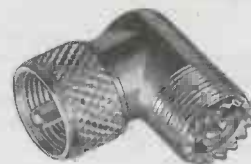

Connector #50.415
Navy Part #CI-49544

Adapter is designed for interconnection of certain British and U. S. Army-Navy coaxial plugs or to permit the use of both U. S. Army-Navy and British plugs in the same piece of equipment. See table of possible connections in Bulletin #6.

U.S. Army Navy
Co-axial Connectors

For more detailed information, including dimension drawings, write for Bulletins #4 and #6.



CONNECTOR DIVISION OF
INTERNATIONAL RESISTANCE CO.

DEPT. D-2, 401 NORTH BROAD STREET, PHILADELPHIA 8, PA.

MILLIWATTS



Why Western Electric equipment leads the way!

1. Western Electric products are designed by Bell Telephone Laboratories — world's largest organization devoted exclusively to research and development in all phases of electrical communication.
2. Since 1869, Western Electric has been the leading maker of communications apparatus. Today this company is the nation's largest producer of electronic and communications equipment.
3. The outstanding quality of Western Electric equipment is being proved daily on land, at sea, in the air, under every extreme of climate. No other company has supplied so much equipment of so many different kinds for military communications.

Western

From tiny tubes to eight foot water cooled giants — from vest pocket aids for the hard of hearing to super-powered radio transmitters — Western Electric has led the way in electrical communications equipment for many years.

Western Electric vacuum tubes for over 30 years have been noted for their uniformity and long life. Scores of new and radically different



BROADCASTING



MARINE RADIO



AVIATION RADIO



MOBILE RADIO

Western Electric has specialized

or KILOWATTS

Electric
equipment leads the way!

types of tubes have been introduced by Western Electric and Bell Telephone Laboratories for war services. These new tubes—and the techniques used in developing and manufacturing them—will find many important uses in communications at the war's end.

In all forms of electrical communications, count on Western Electric for continuing leadership.



*Buy all the War Bonds you can
... and keep all you buy!*



SOUND SYSTEMS



TELEVISION



HEARING AIDS



ACOUSTIC INSTRUMENTS

knowledge in all of these fields

PERFORMANCE

in a tiny package

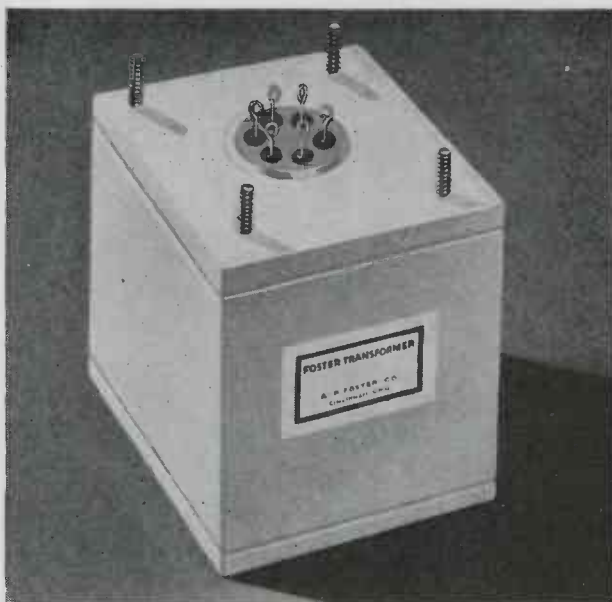

It had to be small, this new MULTIPLE CHANNEL BAND PASS FILTER, because it's destined to do a special military job. **FOSTER** designed and is building it, meeting the high performance standard required, kept it light in weight, and sealed it in a case that measures only $2\frac{3}{4} \times 2\frac{3}{4} \times 3\frac{1}{4}$!"

Terminals are sealed in VITROSEAL, a basic advance in transformer manufacture, exclusive with Foster. VITROSEAL terminals are fused uniformly, simultaneously, into the metal, in multiple. The job is neat, fast, economical. The seal is sure and extremely resistant to vibration and thermal shock.

In the past 12 months Foster Engineers have solved more than 1000 individual transformer problems, designing and building entirely new units or "upping" the performance of units already in use.

If you manufacture electrical and electronic equipment, it may well be worth your while to address your special transformer inquiries to Foster.

REPRESENTATIVES

BOB REID

810 WEST 57TH STREET

INDIANAPOLIS 5, IND.

TELEPHONE: BROADWAY 2725

BAUMAN & BLUZAT

2753 WEST NORTH AVENUE

CHICAGO 47, ILL.

TELEPHONE: HUMBOLT 6809-10-11-12

SPECIALISTS IN BUILDING TRANSFORMERS SINCE 1938

A. P. FOSTER COMPANY

TRANSFORMER ENGINEERS & MANUFACTURERS

719 WYOMING AVENUE, LOCKLAND 15, OHIO (SUBURB OF CINCINNATI)

SPARE PARTS BOXES

...in every needed size!

...for every needed use!

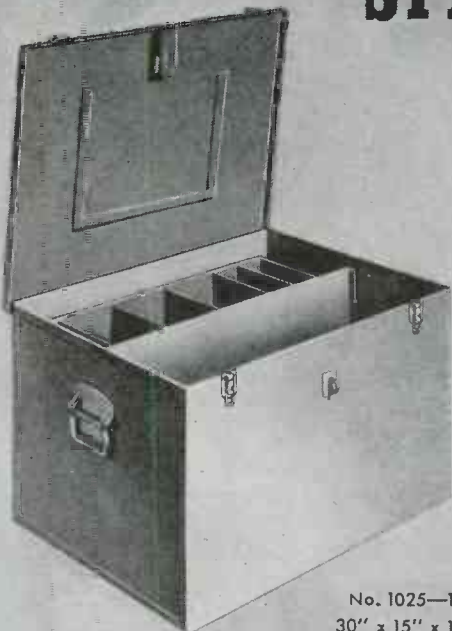

No. 1025-14
30" x 15" x 12"
(Partitions not included)



No. 1025-6
18" x 9" x 9"

24 STOCK SIZES

As per specification 42 B.9 (Int) for shipboard use, Electrical and Mechanical. Navy grey finish. Immediate Delivery.

— WRITE FOR PRICE LIST —

Number	Length	Width	Height	Number	Length	Width	Height
1025-1	12	6	6	1025-13	18	18	12
1025-2	12	9	6	1025-15	24	15	12
1025-3	12	12	6	1025-16	24	15	15
1025-4	12	9	9	1025-17	24	18	12
1025-5	18	9	6	1025-18	24	18	15
1025-6	18	9	9	1025-19	24	18	18
1025-7	18	12	9	1025-20	24	12	9
1025-8	18	6	6	1025-23	30	15	9
1025-9	18	15	9	1025-14	30	15	12
1025-10	18	12	6	1025-22	36	12	9
1025-11	18	15	12	1025-21	42	9	9
1025-12	18	12	12	1025-24	42	12	9

COLE

STEEL EQUIPMENT COMPANY

349 Broadway, New York 13, New York • Factory: Brooklyn, New York

COLE STEEL OFFICE EQUIPMENT

will again be available after the war



**COILS, NAW, MISTER, DERE AIN'T NO SHORTAGE.
ALBION CAN SHIP ALL DE COILS YOU NEED!**

SUPER-QUALITY COILS AT REASONABLE PRICES

More and more every day, the industry is turning to Albion for fast, quality and quantity production of coils, chokes, and transformers. That's because here you benefit from the unbeatable combination of management "know how," skilled workmanship, streamlined facilities, and central location. Your requirements will be given prompt and thoughtful attention.

**ALBION
COIL COMPANY**

ALBION, ILLINOIS

R. F. AND TRANSMITTING COILS AND CHOKES,
I. F. TRANSFORMERS

FROM THE ARCTIC

TO THE TROPICS

Unfailing Dependability

TURNER 99 DYNAMIC.

The most rugged microphone in the entire Turner line. Engineered and built for the discriminating user who wants utmost efficiency and dependability. Available as No. 999 with Balanced Line features for critical applications. Write for complete specifications and details.

Built to stand up and deliver under the most difficult acoustic and climatic conditions, Turner Microphones are "sound" instruments of rugged dependability. For indoor or outdoor use in arctic cold, desert heat or tropic humidity, they're precision engineered to give crisp, clear transmission of any sound, with all gradations of tone and volume faithfully reproduced without distortion or blasting.

In every theater of military operations—on land, on sea, and in the air—in critical P.A., recording or broadcast work—wherever accurate transmission of voice, music or any sound is vital, Turner Microphones set the standard for unfailing performance.

The TURNER Company
Cedar Rapids, Iowa

Turner
99 and 999



There is a Turner Microphone for every electronic communications application. Get the complete Turner story from Turner engineers. Write for Free Illustrated Catalog giving details and specifications on all Turner Microphones for recording, P. A., amateur or commercial broadcast work. Write today.

Turner
Microphones

TURNER—Pioneers in the communications field

SYLVANIA NEWS

ELECTRONIC EQUIPMENT EDITION

APRIL

Published in the Interests of Better Sight and Sound

1945

Miniature Pentode Designed for Use In UHF Circuits

Tube Type 6AK5, a new addition to Sylvania Electric's line, is a miniature sharp cut-off pentode in the short bulb, and is especially suitable for use in ultra high

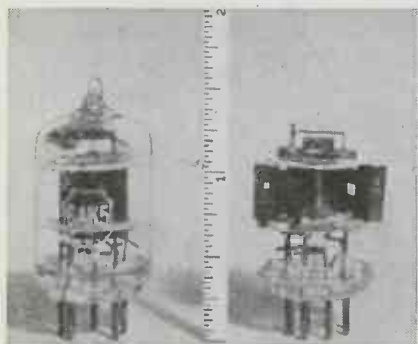

frequency equipment. Small size and high efficiency make it useful in portable equipment.

Full technical information may be obtained from Sylvania Electric.

SYLVESTER SURVEY



"Would you say your postwar radio choice would be the large console type or the smaller, table-top model?"

Oscillographic Technique Traces Tube Performance in New Regions

*Method Devised by Sylvania Electric
Throws New Light on Characteristics*



The measurement of tube characteristics in regions where previous test methods were inapplicable has been made possible through the development, by Sylvania Electric, of a new procedure, based on photographing an oscillographic trace.

EARLIER METHODS

Formerly, tube characteristics were taken by a point-by-point method. This was extremely slow, and had the still greater disadvantage that it could be used only in those parts of the characteristics where the tube would not be damaged by continuous operation. In many recent appli-

cations, characteristics must be known in regions where a plate or grid would vaporize if left on for even a second.

PHOTOGRAPHIC RECORDING

The new technique permits taking of characteristics in these regions. The oscillographic trace of the characteristics is shown on a special Sylvania 7-inch cathode ray tube, and may be photographed.

Improved tubes and circuits are expected to result from the use of the new method, equipment for which was built in Sylvania Electric's Commercial Engineering Laboratory.

SYLVANIA ELECTRIC

SYLVANIA ELECTRIC PRODUCTS INC., Emporium, Pa.

MAKERS OF RADIO TUBES; CATHODE RAY TUBES; ELECTRONIC DEVICES; FLUORESCENT LAMPS, FIXTURES, ACCESSORIES; INCANDESCENT LAMPS

Finding 100 Million Dollars in Ores with "Black Light" ... and **MALLORY VIBRATORS**



THE MINERALIGHT, a quartz ultra-violet lamp, has been used to locate scheelite, or tungsten ore, worth more than \$100,000,000. Other valuable ores are located, mined and sorted with the help of this "black light" lamp which is used in darkness to excite vivid color responses from fluorescent and phosphorescent materials.

Mineralight lamps are designed to operate from a 6-volt battery. By means of a Mallory Vibrator and a transformer, the voltage is stepped up to 600 or 1500 volts AC, depending upon the size of the lamp.

According to Ultra-Violet Products, Inc., Los Angeles, manufacturers of Mineralight:

"The Mallory Vibrator has been found to give us far better results than any other vibrator on the market. We have tested many different makes and find that we secure a higher efficiency of ultra-violet output by using the Mallory Vibrator than with any other type."



PHOTOS COURTESY ULTRA-VIOLET PRODUCTS, INC.

Standard Mallory Vibrators and Vibrapacks* are available from your nearest Mallory Distributor. Ask him for a catalog describing all Mallory precision electronic products, or write us for a free copy today.

Inquiries are invited from manufacturers for Vibrators and Vibrapacks for use in original equipment.

P. R. MALLORY & CO., Inc., INDIANAPOLIS 6, INDIANA



*Reg. U. S. Pat. Off. for vibrator power supplies.



P. R. MALLORY & CO. Inc
MALLORY

**VIBRATORS
and VIBRATOR POWER SUPPLIES**

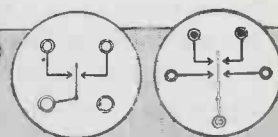
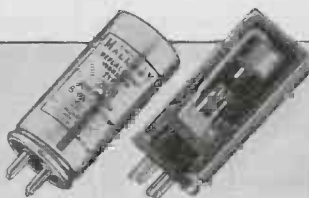



Crystal gateways for your voice

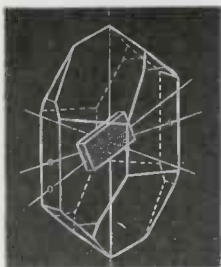
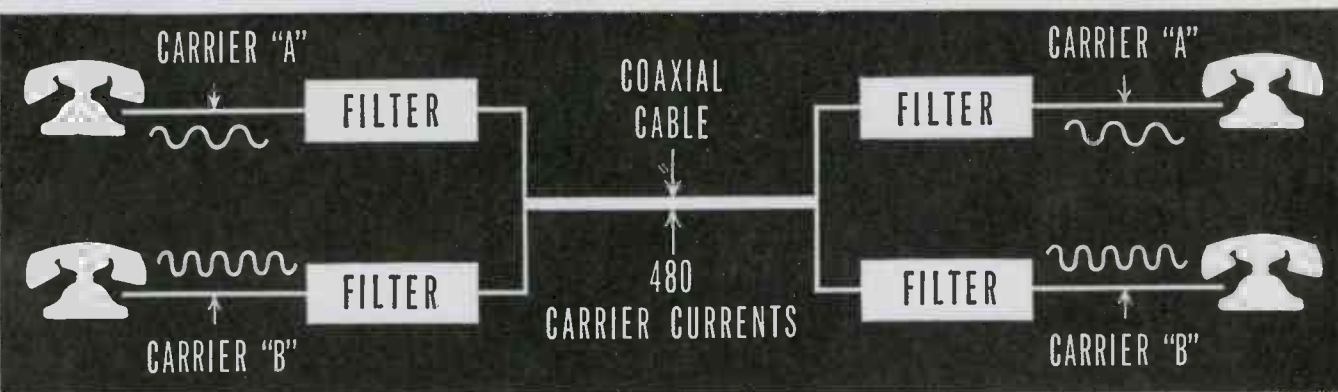

Four hundred and eighty telephone conversations over a coaxial cable was one of the last peacetime achievements of communication research in Bell Telephone Laboratories. In this multi-channel telephone system, each conversation is transported by its own high-frequency carrier current. At each

end of the line are crystal gateways; each opens in response to its own particular "carrier" with the message it transports. In telephone terminology, these gateways are filters.

The ultra-selective characteristic of these filters is made possible by piezo-electric quartz plates, cut in a special

manner from the mother crystal, and mounted in vacuum. Each set of plates is precisely adjusted so that the filter responds only to the frequency of its assigned channel, rejecting all others. In the coaxial terminal equipment, such crystal gates sort out messages for delivery to their four hundred and eighty individual destinations.

In recent years, Bell Telephone Laboratories research has provided the Armed Forces with many types of electrical equipment in which frequency is controlled by quartz crystals. Notable is the tank radio set which enables a tank crew to communicate over any one of 80 different transmission frequency channels by simply plugging in the appropriate crystal. The future holds rich possibilities for the use of quartz crystals in Bell System telephone service.

BELL TELEPHONE LABORATORIES



Exploring and inventing, devising and perfecting for our Armed Forces at war and for continued improvements and economies in telephone service.

constant supervision by

specialists

Although this operator has long been skilled in the winding of foil and tissue for Cornell-Dubilier capacitors, she looks to her supervisor for pointers when a new job is started. All along the line, production technique keeps pace with new improvements and innovations in our products.



Vigilance in little details is second-nature to C-D craftsmen.

Accuracy is their creed.

With such watchful care, capacitor-building becomes a precise science . . . a science that has earned for Cornell-Dubilier capacitors a world-wide reputation for quality and dependability.

If you have a capacitor problem, you may find the answer in one of our basic innovations in design, engineering or manufacture. Cornell-Dubilier Electric Corporation, So. Plainfield, N. J. Other plants: New Bedford, Brookline, Worcester, Mass., Providence, R. I.

TJU TRANSMITTING CAPACITOR

Hermetically sealed in non-corrosive container. Compact, lightweight, furnished with universal mounting clamp, well-insulated terminals. Extra high dielectric strength. Wide range of voltage ratings.



CORNELL - DUBILIER
CAPACITORS 1910  1945

WET AND DRY ELECTROLYTICS MICA • DYKANOL • PAPER •

ALDEN

for Graphic Recording of any kind

OUR YEARS OF EXPERIENCE, and cumulative skills, in the designing and production of RADIO COMPONENTS, are now being used in making equipment which covers the entire field of FACSIMILE.

Actual service, as found in war and communication work under all conditions, has given a PRACTICAL quality to our equipment which, under ordinary conditions, would not have been obtained in years of engineering with limited application.

ALDEN PRODUCTS COMPANY is manufacturing practically ALL TYPES AND SIZES of facsimile and impulse recording equipment—using all the varied recording mediums: Photographic Paper, Film, Electrolytic Paper, Teledeltos, and Ink.

ALFAX IMPULSE RECORDING PAPER

By "COVERING THE ENTIRE FIELD," we mean . . .

1. Some of our equipment has been used for the transmitting and receiving of photographic pictures of reasonably high resolution (such as the war pictures now appearing in the news).

2. Continuous Recorders—of the type whose value has been proven on National and International news service circuits—are now on their way to the Orient, to be used for the receiving of the so-called "picture" languages. They use ALFAX paper.

3. Also, through the use of ALFAX (the first high-speed black and white permanent recording paper), HIGH-SPEED Signal Analysis Equipment has been made possible for various laboratories and Government Departments. Other equipments have employed Teledeltos Paper for message work and other purposes.

4. For outlying posts, where servicing equipment is an impossibility, or where radio or wire links are of poor quality and power, ALDEN Tape Recorders (recording medium, ink)—have been designed to operate with a minimum of trouble and adjustments, and have PROVED MOST SATISFACTORY.

5. The ability of ALFAX Paper and ALDEN Machines to record impulses as they occur, without the inertia problems of many previous methods, has made possible other recorders at various speeds (including slow). They will record a whole day's history of related phenomena, with time indicated, and often—with self-calibrated linear reference marks for ready interpretation.

ALDEN PRODUCTS COMPANY

117 North Main Street

BROCKTON 64G, MASSACHUSETTS



BLAW-KNOX and the voice of radio

Blaw-Knox Towers have played an important part in radio since the early days of Marconi. Most Radio Towers*, here and abroad, are of Blaw-Knox design or manufacture. Blaw-Knox's importance in military electronic development cannot now be disclosed.

What Blaw-Knox means to radio, it means to many other industries. If you are concerned with modern methods for converting raw materials to usable products by chemical or mechanical means, or solvent recovery . . . or any ramification of industrial processing, Blaw-Knox can carry on from pilot plant to full scale production. Blaw-Knox can serve in other ways: with prefabricated piping, equipment for the steel industry and a broad line of construction equipment, to name a few. Let us discuss your problems with you—at your convenience.

*The Tower is an essential part of the voice of radio. Blaw-Knox Towers (some over 120' high) are used for broadcasting, communication, navigation, television, facsimile, police work . . . as well as for undisclosed electronic purposes.

BLAW-KNOX

A PIONEER OF
AMERICAN INITIATIVE
AND GENIUS

 COMPANY

2048 FARMERS
BANK BLDG.,
PITTSBURGH, PA.

LEWIS FOUNDRY & MACHINE DIVISION,
Rolls and Rolling Mill Machinery

POWER PIPING DIVISION, Prefabricated Piping Systems

COLUMBUS DIVISION, Ordnance Materiel

SPECIAL ORDNANCE DIVISION,
Bofors Anti-Aircraft Gun Mounts and Mechanisms

BLAW-KNOX DIVISION, Chemical & Process Plants &
Equipment, Construction Equipment, Steel Plant
Equipment, Radio & Transmission Towers . . .
General Industrial Products

PITTSBURGH ROLLS DIVISION,
Rolls for Steel and Non-Ferrous Rolling Mills

UNION STEEL CASTINGS DIVISION,
Steel and Alloy Castings

NATIONAL ALLOY STEEL DIVISION,
Heat and Corrosion-Resistant Alloy Castings

MARTINS FERRY DIVISION,
Bofors Anti-Aircraft Gun Mounts

BLAW-KNOX SPRINKLER DIVISION,
Automatic Sprinklers and Deluge Systems

A FEW VICTORY PRODUCTS

ANTI-AIRCRAFT GUN MOUNTS GUN SLIDES LANDING BARGES SYNTHETIC RUBBER PLANTS PIPING FOR NAVAL VESSELS
POWDER PLANTS ROCKETS 16" PROJECTILES CAST ARMOR FOR TANKS & NAVAL CONSTRUCTION CHEMICAL PLANTS

SENSITIVITY

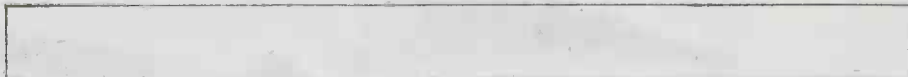

CONTACT
PRESSURE



DEPENDABILITY



DURABILITY



COMPACTNESS



VERSATILITY

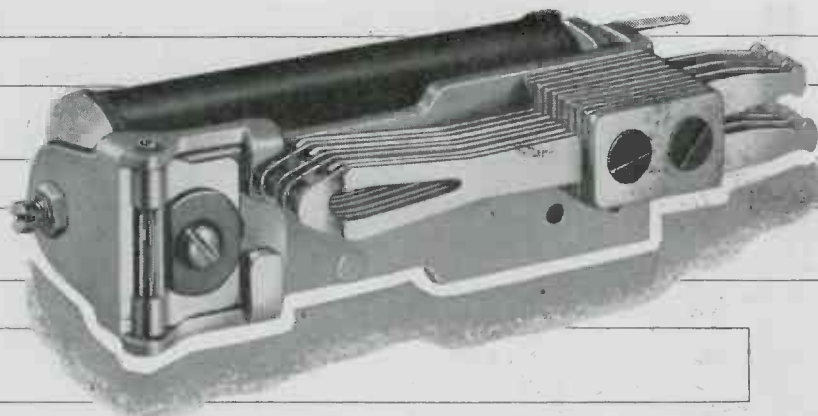

— in Greatest Combination

THE NEW AUTOMATIC ELECTRIC CLASS "B" RELAY

• When you need a relay that's sensitive enough to operate on minute current, yet has the high contact pressure needed for perfect closure, you'll find the Automatic Electric Class "B" Relay worth investigating.

If you need a relay that will switch many circuits, yet is compact enough for multiple mounting in small space, you'll find Class "B" the perfect solution.

Or perhaps you are interested in extra durability, for long service under tough conditions. Then you'll need the in-built quality for which Class "B" has become famous.

No other relay—even in the Automatic Electric line—can give you a greater combination of all these essential qualities. Get the full story on Class "B"—one of the forty basic types described in the Automatic Electric catalog. Ask for your copy of Catalog 4071.

CHECK THESE FEATURES of the New Class "B" Relay

Independent Twin Contacts—for dependable contact closure.

Efficient Magnetic Circuit—for sensitivity and high contact pressure.

Unique Armature Bearing—for long wear under severe service conditions.

Compact Design—for important savings in space and weight.

Versatility—Available for coil voltages to 300 volts d-c and 230 volts a-c, and with capacities up to 28 springs; also with magnetic shielding cover, when specified.

**No other relay can give you
a greater combination of
all these essential qualities.**

Relays

AND OTHER CONTROL DEVICES

by **AUTOMATIC
ELECTRIC**



AUTOMATIC ELECTRIC SALES CORPORATION

1033 West Van Buren Street • Chicago 7, Illinois

In Canada: Automatic Electric
(Canada) Limited, Toronto

PARTS AND ASSEMBLIES FOR EVERY ELECTRICAL CONTROL NEED

JOHNSON *for* HIGH POWER COMPONENTS

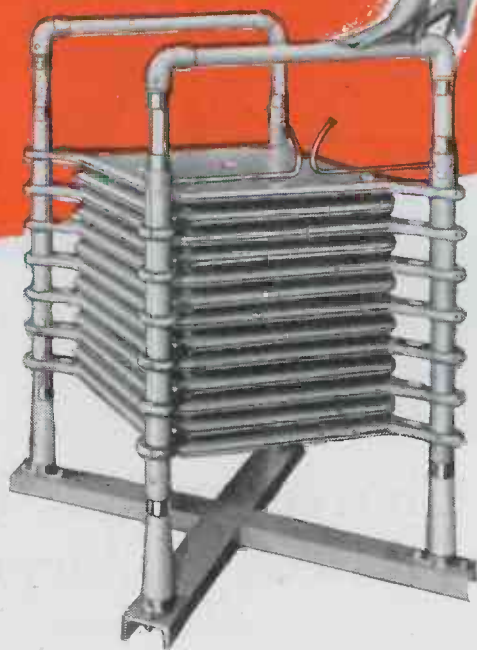

To meet the need for a light-weight, high-capacity, high-voltage tank condenser for transmitter applications, Johnson engineers developed a new type of condenser. The unit illustrated has a capacity of 1200 mmf. at a peak voltage of 40,000 volts at 2 megacycles. Nearly any combination of capacity and voltage ratings may be had. The capacity may be varied in the field by removing plates or altering spacing.

The plates are made of fabricated sheet steel, heavily copper plated and enamelled. Rounded edges increase the breakdown voltages. Vertical tie rods of copper tubing furnish good conductivity between plates. Plates are secured to the upright supports with aluminum castings.

A protective gap is incorporated in the condenser to protect the plates from damage in case of excessive voltages or surges. The mounting base is welded channel iron, which forms a strong support. A very convenient mounting for the tank inductance is formed by the two cross beams at the top of the condenser.

This condenser will find wide application in high power equipment because of its compact and efficient construction.

Ask for Catalog No. 9680

Other JOHNSON Products
for High Power

- INDUCTORS, variable & fixed
- TRANSMISSION LINE EQUIPMENT
- SOCKETS
- SWITCHES
- COUPLINGS
- CHOKES
- ANTENNA PHASING UNITS
- GAS-FILLED CONDENSERS
- CONTACTORS
- INSULATORS



JOHNSON

a famous name in Radio

E. F. JOHNSON COMPANY • WASECA • MINNESOTA



Above—Specially designed B-L heavy duty transformer—used in battery charger. Delivers 12 volts, stepped down from 115 volt power supply.

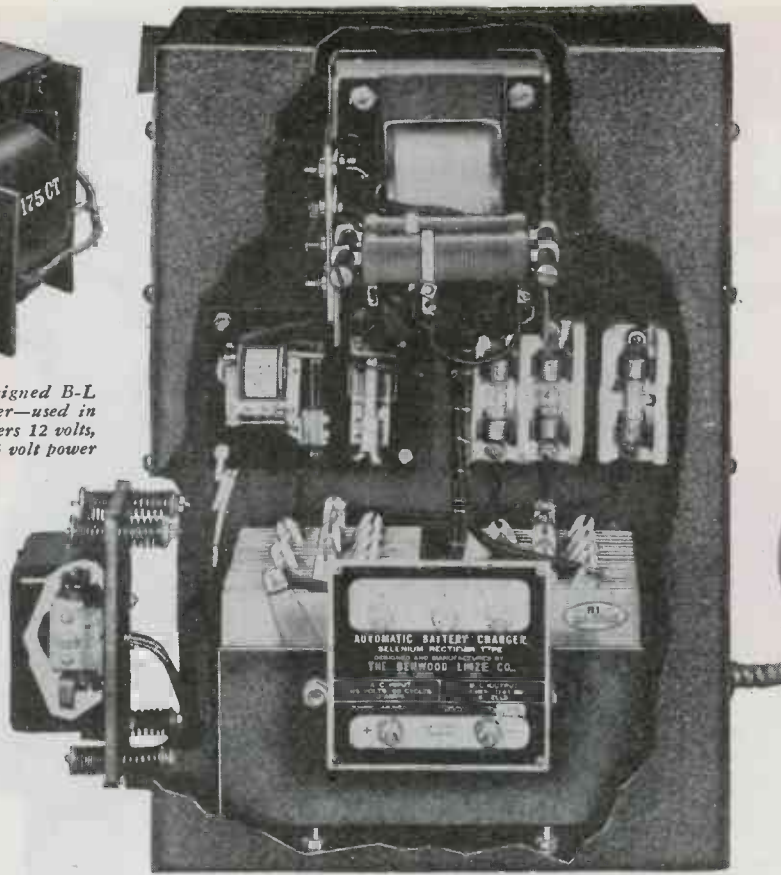

At left—Another example of B-L Battery Charger designed to meet specific needs.



Above—Specially designed B-L Selenium Rectifier converts AC to DC in the Battery Charger.

This B-L Battery Charger was designed to meet special need in Airport Fire Truck

It maintains a 12 volt, 6 cell heavy-duty storage battery, which is a component part of the fire truck shown at the right, and furnishes power for mechanical operation of the booms directing the mass carbon dioxide discharge.

Since the nozzles must be directed to the proper position in extinguishing a fire, reliability of the mechanical drive, including the battery, is very important.

The battery is kept fully charged at all times by means of a trickle charge supplied by this B-L Charger. When the truck returns after use, the charger provides a 12 ampere rate for rapid recharging and automatically reduces to the trickle rate when battery charge reaches a pre-determined value. The battery is thus fully recharged within a short period of time and maintained at full charge. The operation of this charger is fully automatic and it requires no attention.

The charger is mounted in the body of the truck and is of rugged construction, capable of withstanding severe shocks such as those encountered in operating mobile

equipment over rough terrain. It is provided with a B-L selenium rectifier comprising two stacks, a heavy-duty B-L transformer, relays for automatic charge rate control and adjustable pre-set resistors. The entire equipment is housed in a heavy gauge steel cabinet.

Cardox Airport Fire Truck—(capacity, 3 tons of liquid CO₂ supplemented by 500 gallons of foam)—extinguishing in 20 seconds simulated crash fire, involving 400 gallons of gasoline and 150 gallons of oil.



Have You a Conversion Problem?

Twenty-five years of B-L specialized skill in AC-DC conversion problems is available to you. We are designers of Selenium and Copper Sulphide Rectifiers, Battery Chargers, and DC Power Supplies for practically every requirement. We invite your inquiries—address Dept. B.

SELENIUM



COPPER
SULPHIDE

THE BENWOOD LINZE COMPANY

1815 Locust Street • • • St. Louis 3, Mo.

DESIGNERS AND MANUFACTURERS OF SELENIUM AND COPPER SULPHIDE RECTIFIERS, BATTERY CHARGERS, AND D. C. POWER SUPPLIES FOR PRACTICALLY EVERY REQUIREMENT.

"SEALED LIKE A

VACUUM TUBE"

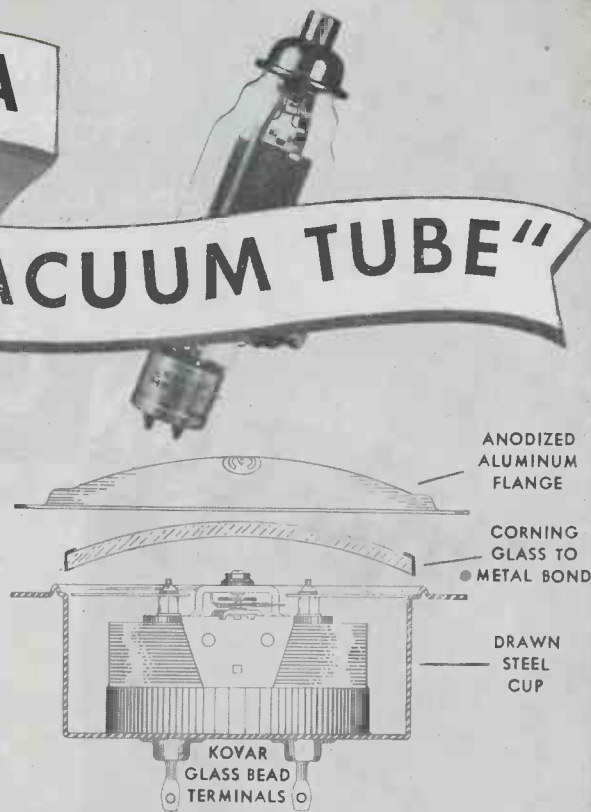
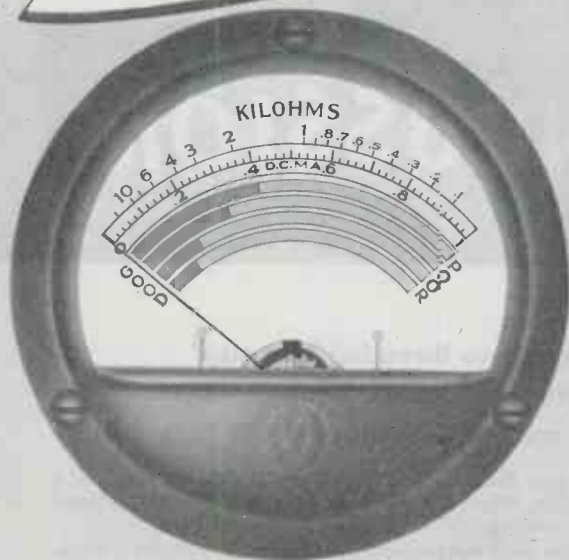

At last . . . a truly satisfactory answer to the urgent need for a tropicalized electrical indicating instrument

Glass-to-Metal Hermetically Sealed 2½" and 3½" Instruments by Marion

Utilizing an entirely different design and construction approach, Marion engineers have completely licked one of the toughest problems ever assigned to our industry. By building the mechanism into a protective cup-like frame, and then sealing the glass cover to the metal rim, unequivocal hermetic sealing has been achieved with a minimum number of seals.

- There are no rubber gaskets, no cement seals.
- Can be immersed in boiling brine solution for weeks without deterioration of seals.
- Windows are of double thickness, tempered glass processed for solder sealing, and are highly resistant to shock.
- Instruments are completely dehydrated and are filled with dry air at sea level pressure.
- A newly designed crowned crystal permits greater scale length, reduces shadows, and makes for better visibility.
- Magnetic shielding permits interchangeability on any type of panel without affecting calibration; can be supplied silver plated for extra R.F. shielding.
- Silver clad beryllium copper hair springs reduce zero shift at all temperatures.
- Standard Kovar glass bead type terminals with solder lugs.
- Special phosphate finish on cases meets two-hundred-hour salt spray test.
- Window sealing process developed and perfected in cooperation with engineers of the Corning Glass Co.
- Instruments manufactured in accordance with AWS Spec. C-39.2 1944 plus hermetic sealing.

TYPE HM 2 DIRECTLY INTERCHANGEABLE WITH AWS TYPE MR 24 AND 25
TYPE HM 3 DIRECTLY INTERCHANGEABLE WITH AWS TYPE MR 34 AND 35

Available in all DC ranges. Write for additional details



MARION ELECTRICAL INSTRUMENT COMPANY

MANCHESTER, NEW HAMPSHIRE

They wanted
TOY-SIZE fastenings
able to withstand



$\frac{3}{4}$ " long, .037" dia.
140 threads to inch.

BIG-GUN CONCUSSION

... and for these threaded "pin size"
parts they chose a strong,
corrosion-resistant INCO Nickel Alloy

The enemy isn't the only one to feel the shattering shock of a naval broadside. When the big guns thunder, everything aboard ship takes a beating.

Yet delicate vital instruments must function without a hitch. Every part... even the tiniest... must be able to withstand the tremendous concussion.

One such part in an essential instrument, is a fastening the size of a common pin... approximately $\frac{3}{4}$ " long, .037" in diameter with 140 threads to the inch.

The metal chosen for this fastening needs:

- corrosion-resistance, a necessity for sea-going equipment.
- strength and toughness, to hold up under shock.
- machinability, to permit speedy, economical machine production.

All of these requirements add up to "R" Monel... the corrosion-resistant alloy for parts where extra machinability is important.

* * *

This use of "R" Monel is cited as an example of how INCO Nickel Alloys... such as "R" and "KR" Monel... often do the trick where a *unique combination* of properties is required.

If you have a problem involving metals... for equipment now in production, or planned for post-war... consult INCO Technical service. Write:

THE INTERNATIONAL NICKEL COMPANY, INC., 67 Wall Street, New York 5, N. Y.

Official U. S. Navy Photograph

140 THREADS TO THE INCH. Shown in this enlarged photograph, demonstrate the remarkable machinability of strong, corrosion-resistant "R" Monel. ("KR" Monel is suggested for applications where extra hardness is required.) The fastenings are machined from .037" diameter cold-drawn "R" Monel.

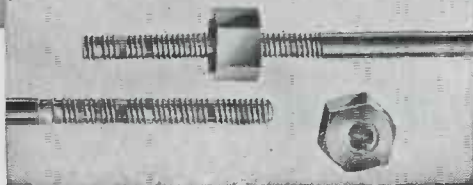

INCO NICKEL ALLOYS

MONEL • "K" MONEL • "S" MONEL • "R" MONEL • "KR" MONEL • INCONEL • "Z" NICKEL • NICKEL
Sheet... Strip... Rod... Tubing... Wire... Castings



Unretouched photograph of the original Machlett Laboratory



The Machlett "White Room", first in the industry



Machlett Laboratories, Springdale

EVEN 43 YEARS AGO Machlett TUBES WERE PRAISED



Machlett Laboratories, Norwalk

IN 1902 Dr. W. J. Morton, distinguished scientist, doctor and pioneer in the then-new field of roentgenology, wrote to Robert H. Machlett:

"My special tube, as you manufactured it, is truly a success and I don't know how I could obtain anything better. Please make me another one as soon as you possibly can."

Though little was known about X-rays at that time, one thing was clear to the men using them: the best tubes available were made by Machlett. We believe that is still true today.

The transition from the original Machlett Laboratory to the two modern plants at Springdale and Norwalk, Connecticut, was a gradual process. It was made possible by constant improvement in the tubes, by developing new techniques for

their manufacture, and by designing and making new types for new applications. Thus Machlett became the largest producer of X-ray tubes in the world.

Today we also apply our half a century of experience to the production of other electron tubes, such as oscillators, amplifiers and rectifiers for radio and industrial uses. For information as to available types of Machlett tubes, write Machlett Laboratories, Inc., Springdale, Connecticut.

ML-893—high power oscillator and amplifier tube for radio and industrial purposes.



APPLIES TO RADIO AND INDUSTRIAL USES
ITS **43** YEARS OF ELECTRON-TUBE EXPERIENCE



**12,000
DEALERS**

**Were Consulted
to Determine**

THE NEW Sentinel LINE

• It is not too early to disclose one thing about the new line which will be available when Sentinel is honorably discharged from war service. It will be a *dealer-line* from the word go! Along with postwar plans for notable new models, and hard-hitting advertising . . . sales helps . . . displays . . . Sentinel asked for the ideas and preferences of 12,000 dealers—by a nation-wide poll recently completed—a solid foundation for tomorrow's merchandising success.

In the interests of its dealers, Sentinel continues aggressive national advertising never interrupted since Pearl Harbor . . . Magazines of large circulation . . . Radio on nation-wide programs.

Sentinel will offer a sound, constructive dealer plan that assures you of quick deliveries, ready consumer acceptance and sure profits.

**Sentinel
RADIO**



QUALITY RADIO SINCE 1920

SENTINEL RADIO CORPORATION, 2020 Ridge Ave., Evanston, Illinois

LISTEN . . .
TO SENTINEL'S
NATION-WIDE
RADIO PROGRAM
John W. Vandercook
analyzes the news
every Saturday after-
noon 5:30 to 5:45
E.W. over NBC's
complete network. See
local newspapers for
time and station.



SCOVILL charted
 a new "course" for
 radio compass
 terminals
 and made them faster
 and better for less

Scovill Electrōnents may give you the same competitive advantages*

Electric terminals for radio compasses were needed faster than screw machines could turn them out of rod stock. Asked to suggest a speedier method, Scovill recommended stamping them out of sheet metal. Given the job, Scovill produced many more terminals per day at a much lower cost... and paid an extra dividend in the form of better electrical properties. That was because the sheet brass

used had a higher copper content and higher conductivity than the brass rod necessary in the former method.

With the same kind of ingenuity applied to your small electronic components or complete assemblies, the chances are that Scovill can save you time and money. Investigate the designing service, manufacturing ability in all metals, and wide range of metal-working facilities that have won for

Scovill the title of "Masters of Metal". Fill in coupon below and mail today.

*Electrōnents = Electronic Components



Please send me a free copy of "Masters of Metal" booklet describing your facilities. I am interested in the ELECTRŌNENT* applications checked.

- | | | |
|--|--------------------------------------|--|
| <input type="checkbox"/> Batteries | <input type="checkbox"/> Dials | <input type="checkbox"/> Panels |
| <input type="checkbox"/> Record Changers | <input type="checkbox"/> Escutcheons | <input type="checkbox"/> Sockets |
| <input type="checkbox"/> Clips | <input type="checkbox"/> Jacks | <input type="checkbox"/> Stampings (misc.) |
| <input type="checkbox"/> Condensers | <input type="checkbox"/> Lugs | <input type="checkbox"/> Tubes |

Other applications.....

SCOVILL MANUFACTURING COMPANY

Electronic Division
 23 Mill Street, Waterbury 91, Connecticut

Name

Company

Address.....



Remler Beauty Has **BRAINS**

NO MERE AUTOMATONS are the girls who tend machines in Remler factories. They know how to make minor adjustments to keep equipment in top running condition; they learn the operation of several machines and switch from one to the other to lessen fatigue. • The machines are "beauties" too. In many instances they have been designed by Remler engineers to perform multiple tasks which save time and speed up deliveries. • For complete sound transmitting systems; radio, plugs, connectors and special electronic devices manufactured to order, consult—

REMLER COMPANY, LTD. • 2101 Bryant St. • San Francisco, 10, Calif.

REMLER

SINCE 1918

Announcing & Communication Equipment

PLUGS & CONNECTORS

Signal Corps • Navy Specifications

Types:		PL		NAF	
50-A	61	74	114	150	
54	62	76	119	159	
55	63	77	120	160	1136-1
56	64	104	124	291-A	
58	65	108	125	354	No.
59	67	109	127		212938-1
60	68	112	149		

PLP		PLQ		PLS	
56	65	56	65	56	64
59	67	59	67	59	65
60	74	60	74	60	74
61	76	61	76	61	76
62	77	62	77	62	77
63	104	63	104	63	104
64		64			

OTHER DESIGNS TO ORDER

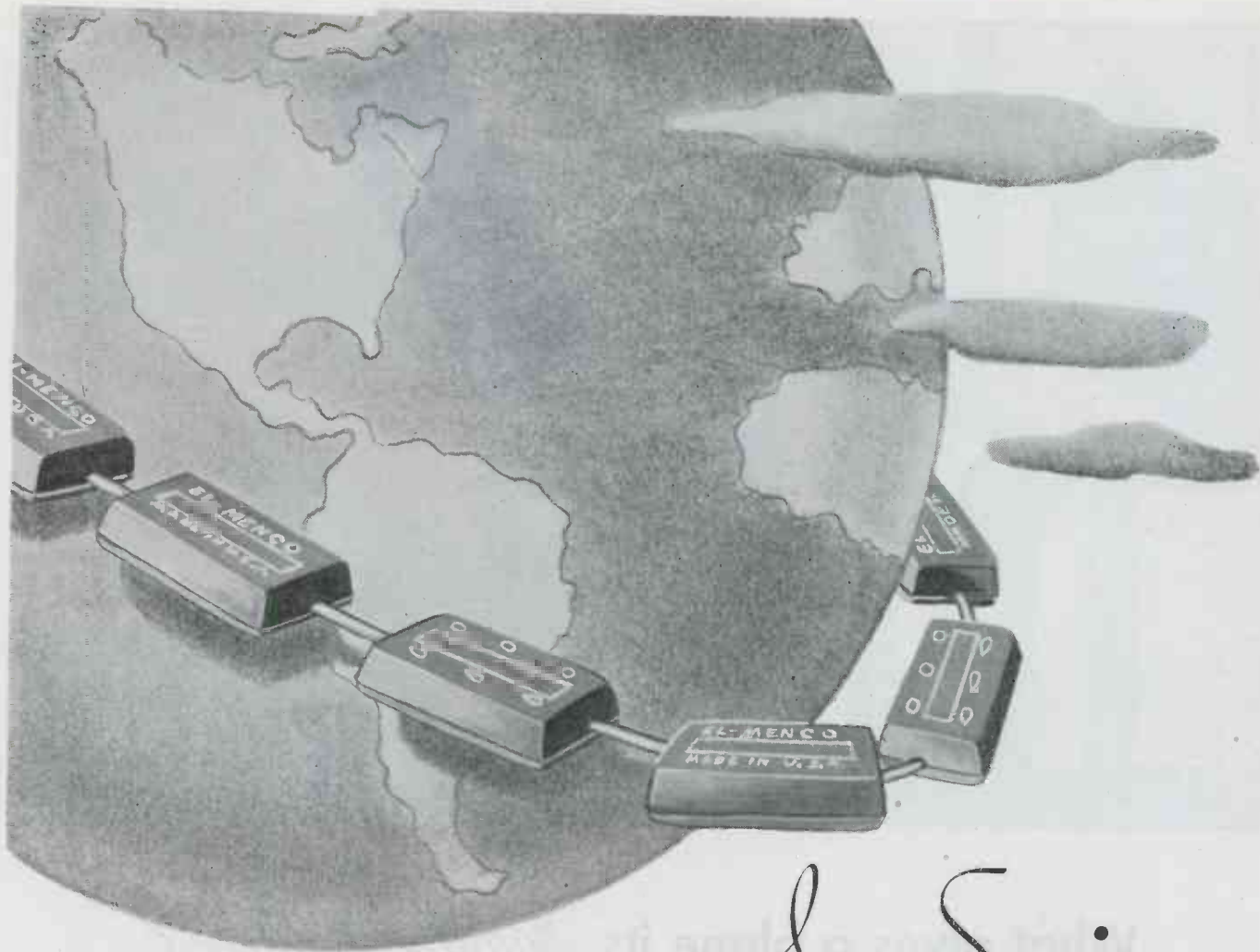

In Service

AROUND THE WORLD

El-Menco Capacitors are serving faithfully at countless vital spots in Army and Navy communications systems wherever they may be.

Because of their recognized high quality we know they will continue to girdle the globe after the war — in products whose manufacturers will demand perfection in *every* detail.

Manufacturers of
Electronic Equipment:

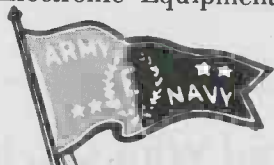

Send, on firm letterhead
for new Capacitor Catalog

THE ELECTRO MOTIVE MFG. CO.
Willimantic, Conn.

EL-MENCO
MOLDED MICA-
MICA TRIMMER
Capacitors

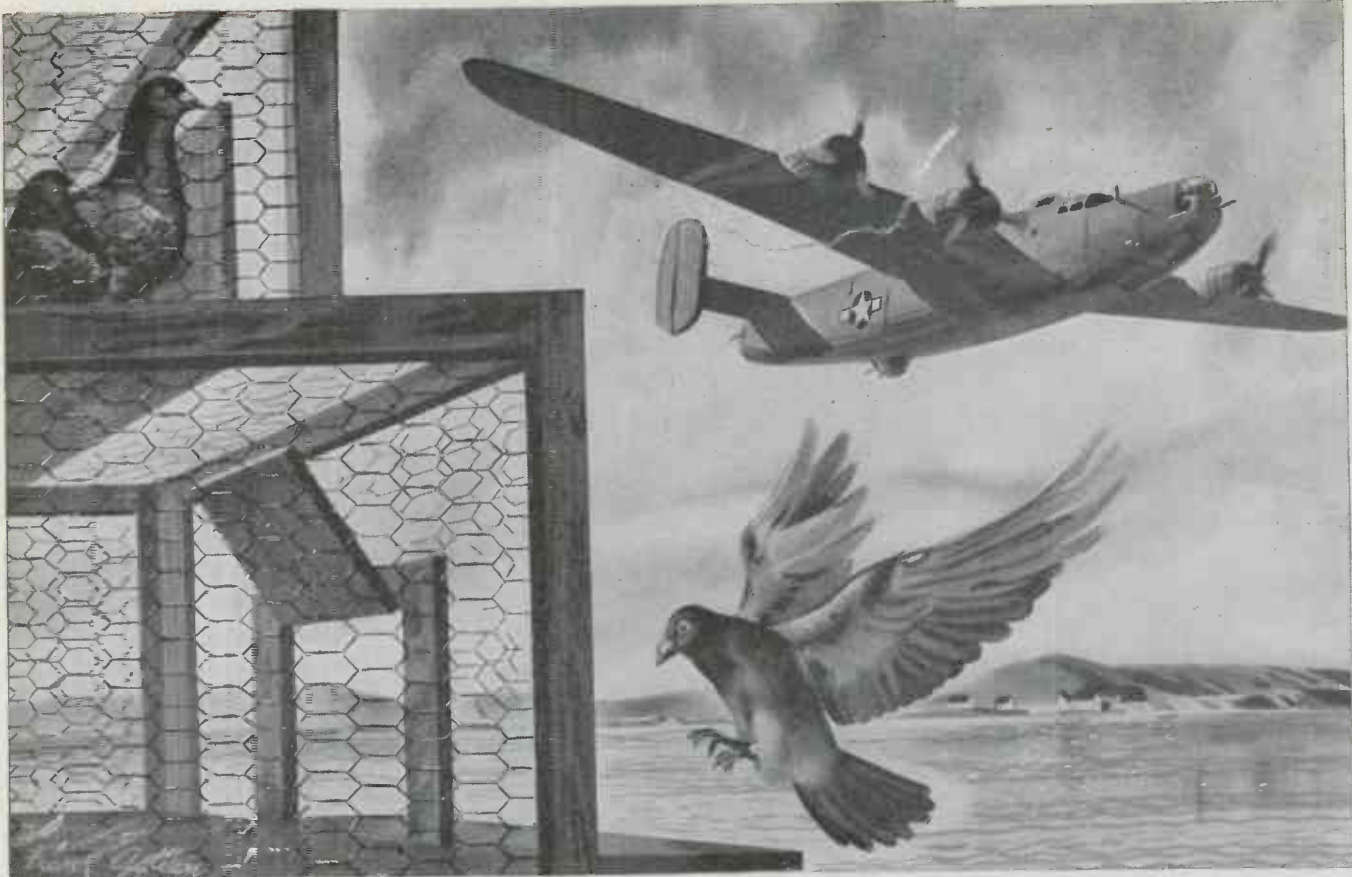

What gives a plane its homing instinct?

IN THESE days when airplanes span continents and oceans non-stop, navigational and communications devices are of critical importance.

For these are the instruments which give an airplane its *homing*



Bendix Type MN-26 Radio Compass

instinct . . . its sense of direction which spells safety and schedule maintenance.

We at the Wheeler Insulated Wire Company take pride in the part which Bendix Aviation Corporation has played in supplying man-made homing instincts to thousands of modern airplanes.

For Wheeler insulated wire goes into both the Bendix aircraft radio compass . . . and the Bendix long-range radio telephone equipment.

Windings for precision-made equipments such as these are part of Wheeler's everyday job. We've been making high quality coils and transformers for 35 years . . . not for a very large list of customers, but for a very fine one.

When wartime demands permit, we hope to introduce our products to many new customers. If you are going to manufacture anything which could use the products we make—Wheeler is a good name to remember.

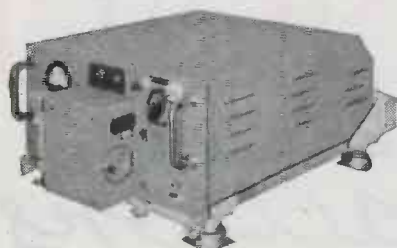

Bendix Type RTA-1B Communication Unit



The Wheeler Insulated Wire Co., Inc.

BRIDGEPORT 4, CONN.

Manufacturers of Magnet Wire...Litz Wire...Coil Windings
Transformers...Ballasts for Fluorescent Lighting

HEAVY-DUTY OIL-FILLED CAPACITORS

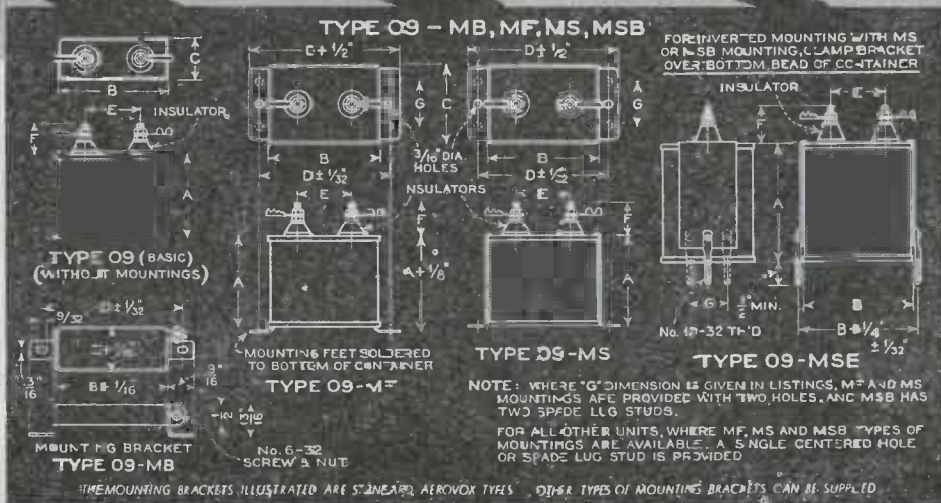
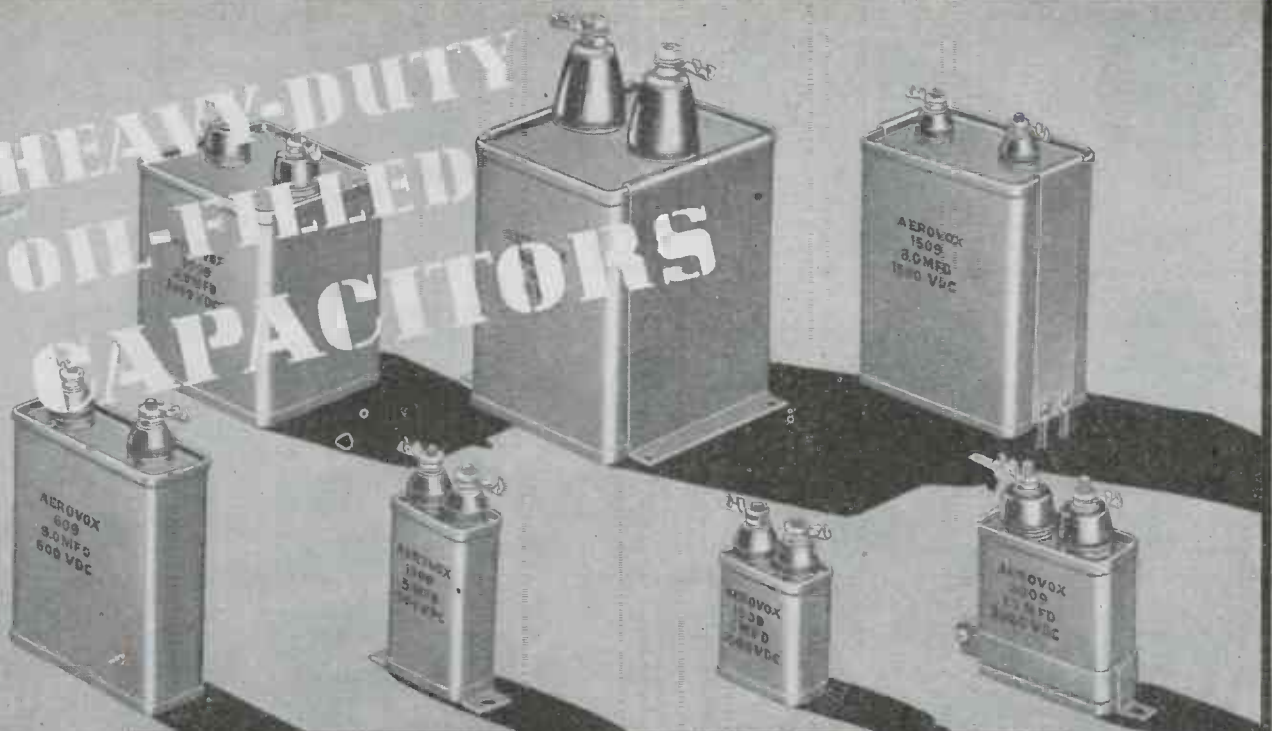

● **VERSATILITY**—with economy of chassis space and assembly operations a prime factor—distinguishes Aerovox Type 09 oil-filled capacitors. Although mass-produced, this type is available in such an outstanding range of voltage and capacitance ratings, as well as mountings, that it is virtually custom-made for most high-voltage heavy-duty applications.

Note particularly the choice of mounting means. Mounting means brackets shown in drawing are Aerovox standard; other types can be supplied. Voltage ratings from 600 to 7500 D.C.W. Widest

selection of capacitance values. Impregnants and fills available are HYVOL (Vegetable) or HYVOL M (mineral oil). The exclusive Aerovox terminal construction means units that pass the standard immersion tests required by various Governmental services. Terminal assembly is non-removable, an integral part of the capacitor.

These capacitors provide maximum capacitance at minimum cost. Widely used for continuous-service in transmitters, amplifiers, rectifier filters and similar applications.

● *Literature on Request*



Capacitors

INDIVIDUALLY TESTED

AEROVOX CORPORATION, NEW BEDFORD, MASS., U. S. A.

SALES OFFICES IN ALL PRINCIPAL CITIES

Export: 13 E. 40 ST., NEW YORK 16, N. Y. • Cable: 'ARLAB' • In Canada: AEROVOX CANADA LTD., HAMILTON, ONT.

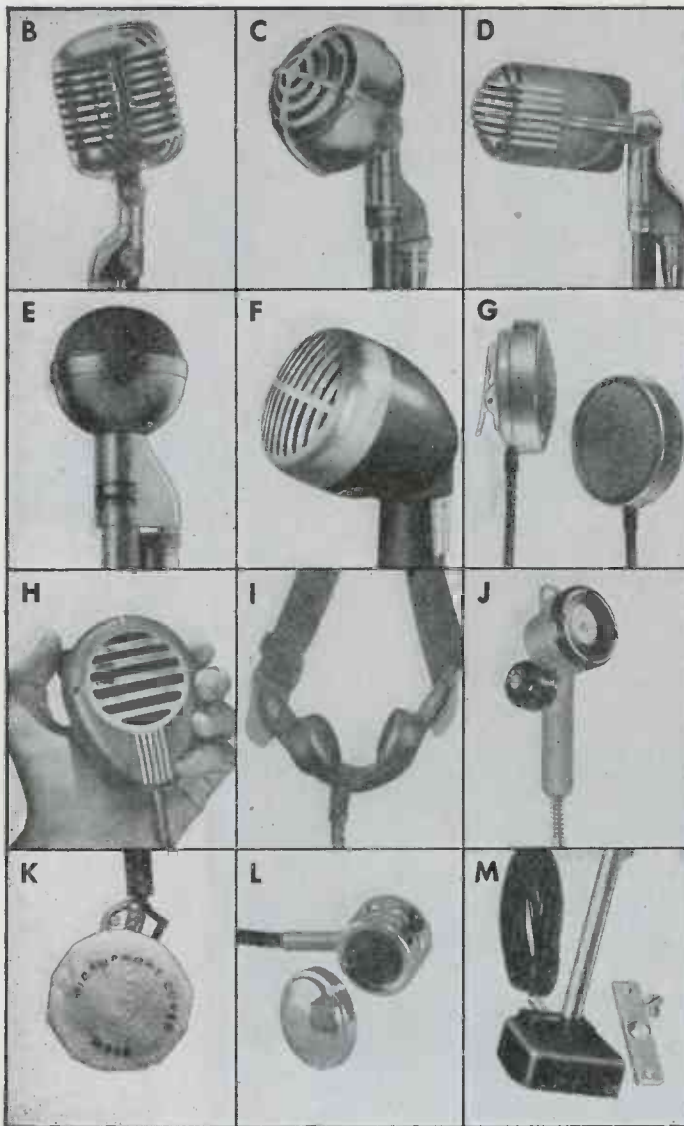

—Your Microphone is here

As outstanding manufacturers of microphones for war —Shure offers a complete microphone line. You will find the proper microphone for every need above. A complete description of any model will be furnished upon request.

- | | |
|-------------------------------------|---------------------------|
| A. Super-Cardioid Broadcast Dynamic | G. Lapel Microphone |
| B. Uridyne Cardioid Dynamic | H. Military Carbon |
| C. Uniplex Cardioid Crystal | I. Throat Microphone |
| D. Stratoliner Dynamic | J. Carbon Hand Microphone |
| E. Laboratory Non-Directional | K. Mask Microphone |
| F. "Economy" Crystal | L. Stethophone |
| | M. Vibration Pick-up |

SHURE BROTHERS

Designers and Manufacturers of Microphones and Acoustic Devices

225 West Huron Street

Chicago 10, Illinois



**"precision
control"**

*in electronic equipment
is a certainty with the*

CETRON CE-309 TUBE



Write for catalog of our
COMPLETE LINE of
Rectifiers . . . Phototubes
. . . Electronic Tubes

Wherever precision control is of prime importance in electronic devices, this CE-309 Thyatron will serve capably and efficiently. It is a mercury vapor filled rectifier designed especially for exceptional service in such operations as handling primary currents of small resistance welders, motor control, etc. It is quick starting, averaging 5 seconds heating time . . . conservatively rated for 2000 hours . . . in every way a tube that reflects Cetron quality engineering and our thorough understanding of the needs and problems of tubes for industrial use.

CONTINENTAL ELECTRIC CO. *Geneva, Ill.*

MALLORY FP CAPACITORS

Brighten the "Eye"
of This New
Electron Microscope



USEFUL magnification in excess of 100,000 times (or diameters), as against 3,000 times with the best optical microscopes is possible with the new RCA Universal Electron Microscope, which is equipped with Mallory FP Capacitors.

A precision instrument such as the electron microscope requires precision parts. In designing the power supply for this new microscope, RCA engineers specified Mallory FP Capacitors in several standard capacities, to assure better definition for the microscope—a brighter "eye". Thoroughly dependable, noted for their long life, these precision-built capacitors are the smallest available for a given electrical rating . . . permitting more compact circuit designs.

Mallory FP Capacitors are furnished in ratings from 10 mfd. to 3,000 mfd. at operating voltages from 10 volts (3,000 mfd.) to 450 volts. Self-contained mounting features assure quick assembly. Extra "hardware" is eliminated because of the patented twisted-ear mounting feature.

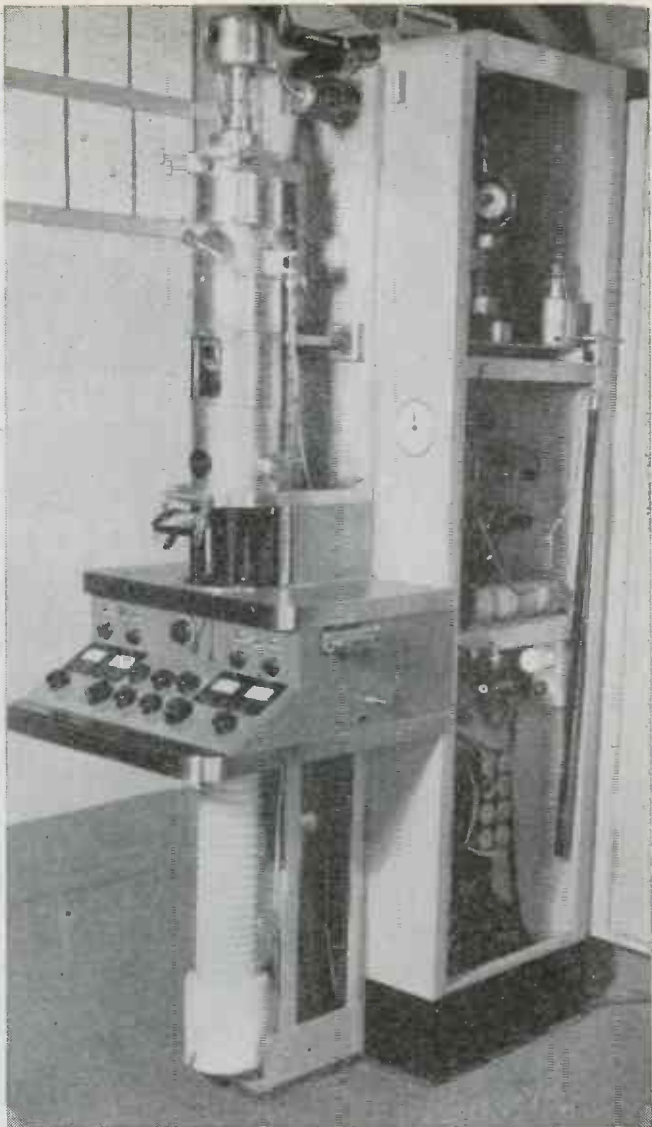

This new RCA Universal Electron Microscope is equipped with Mallory FP Capacitors in several standard capacities.

Ask your nearest Mallory Distributor for a copy of the Mallory catalog, containing full information on capacitors and other precision parts for electronic and electrical equipment. Or write us today.

P. R. MALLORY & CO., Inc., INDIANAPOLIS 6, INDIANA





P. R. MALLORY & CO. Inc.

MALLORY

Electrolytic, Film and Paper CAPACITORS



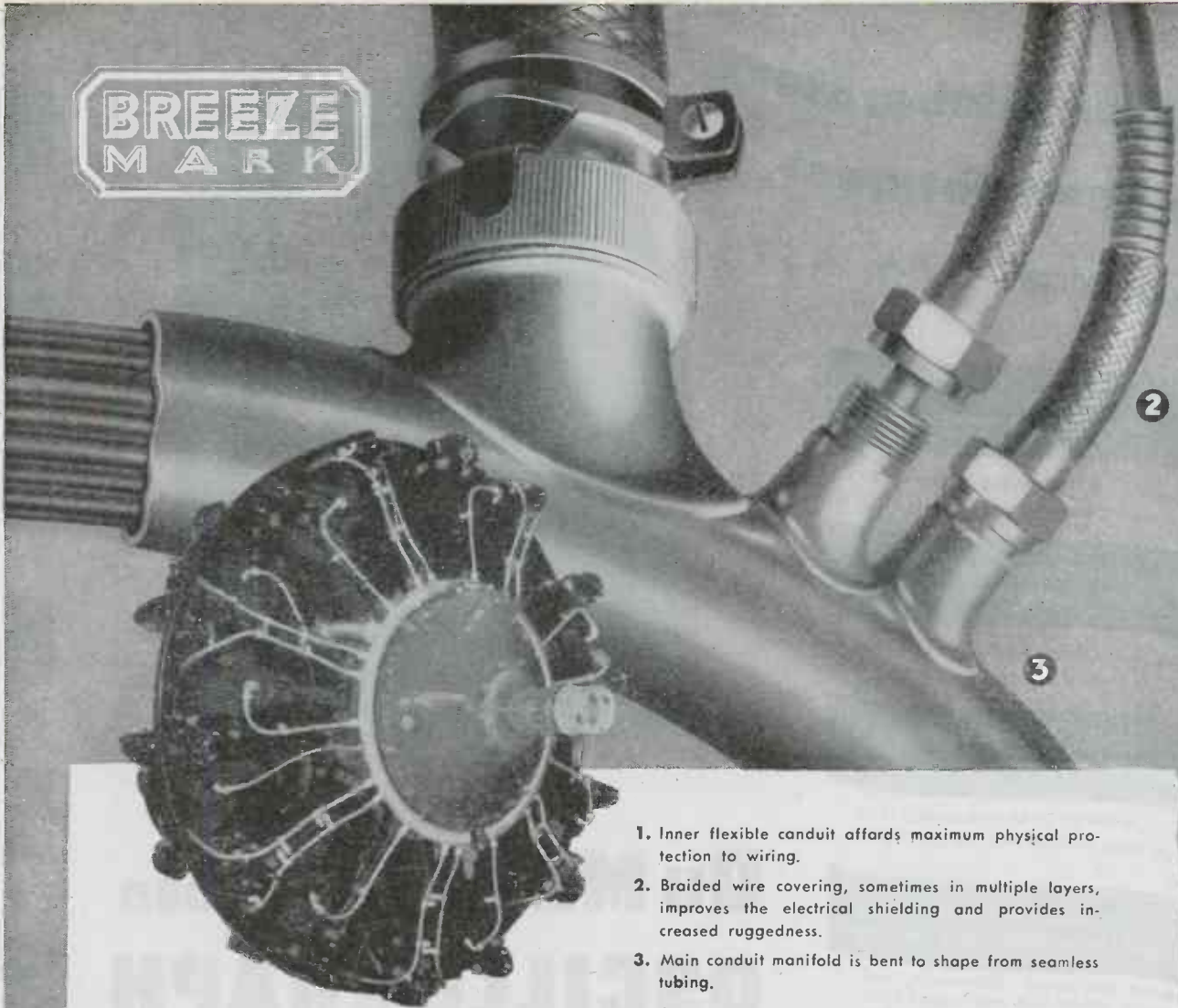

1. Inner flexible conduit affords maximum physical protection to wiring.
2. Braided wire covering, sometimes in multiple layers, improves the electrical shielding and provides increased ruggedness.
3. Main conduit manifold is bent to shape from seamless tubing.

Electrically Sealed Circuits

WITH BREEZE RADIO IGNITION SHIELDING

The Breeze Radio Ignition Shielding which equips the modern aircraft engine is the product of extensive laboratory test and research.

Effective shielding calls for a metal case of high conductivity around possible sources of radio interference, designed to lead off high frequency impulses to the ground and prevent their radiation. Each installation must be custom engineered to meet the needs of the problems involved.

Breeze Shielding is designed for ruggedness, resistance to vibration, and maximum isolation of high frequency interference. Each wire of the braided cover must be positively soldered at each connection, inner conduit must be tight to avoid electrical leakage, and fittings must be precision-machined for close fit and uniform pressure of contact faces.

New shielding problems presented by the rapid advance in the science of radio communication and television are constantly being solved by Breeze engineering. A background of many years experience in shielding automotive, aircraft, marine and commercial engines has made Breeze America's headquarters for Radio Ignition Shielding.

Breeze



CORPORATIONS, INC.

Newark, New Jersey

When a laboratory instrument goes to war ☆ ☆ ☆

Use of mineral-oil-impregnated, hermetically-sealed, paper capacitors.

Increase in voltage rating of certain capacitors for greater factor of safety.

Addition of mounting straps on capacitors subject to breakage in transit.

Use of high-voltage wire in high-voltage circuits in place of previous standard wire.

Addition of tube clamps for tubes subject to jarring loose in transit.

Addition of flange on chassis assembly to provide extra strength against rough handling.

Addition of four bank supports to prevent breakage of banks during rough handling.

Numerous mechanical refinements - better sockets, elastic stop nuts, rolled bead on cathode-ray tube shield, additional brackets.

Change of negative rectifier from Type 1V to Army-Navy preferred Type 6X5GT/G.

Change from 1/4-watt neon tube to Army-Navy preferred Type 991 voltage regulator tube for greater stability.

Inclusion of frequency range adjustment potentiometer in time base as a factory adjustment, for accurate time-base frequency setting.

Change from Type 6F8G tubes to Army-Navy preferred Type 6SN7GT, with improved performance.

All composition resistors operated at less than 40% of power rating; capacitors at less than 80% of voltage rating.

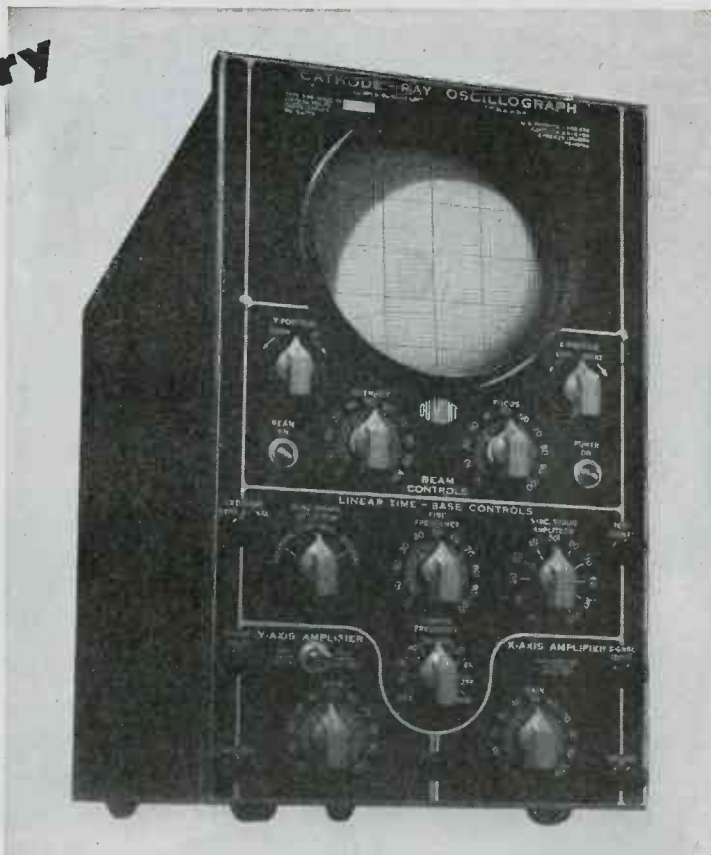

DuMONT Type 208B OSCILLOGRAPH

► Out of the rigorous trials of military service there emerges a better Type 208 DuMont Oscilloscope.

Listed herewith are some of the major design changes and refinements effected during the past two years and currently incorporated in the Type 208B. In every instance the change or refinement has been incorporated in order to improve electrical or mechanical performance.

Thus an already popular oscilloscope which has found the widest usage in peace times becomes a better, more rugged, and more dependable instrument under the trying conditions of field service.

► Write for literature

© ALLEN B. DUMONT LABORATORIES, INC.

DUMONT

Precision Electronics & Television

ALLEN B. DUMONT LABORATORIES, INC., PASSAIC, NEW JERSEY • CABLE ADDRESS: WESPXLIN, NEW YORK

VERNON
GRAFF

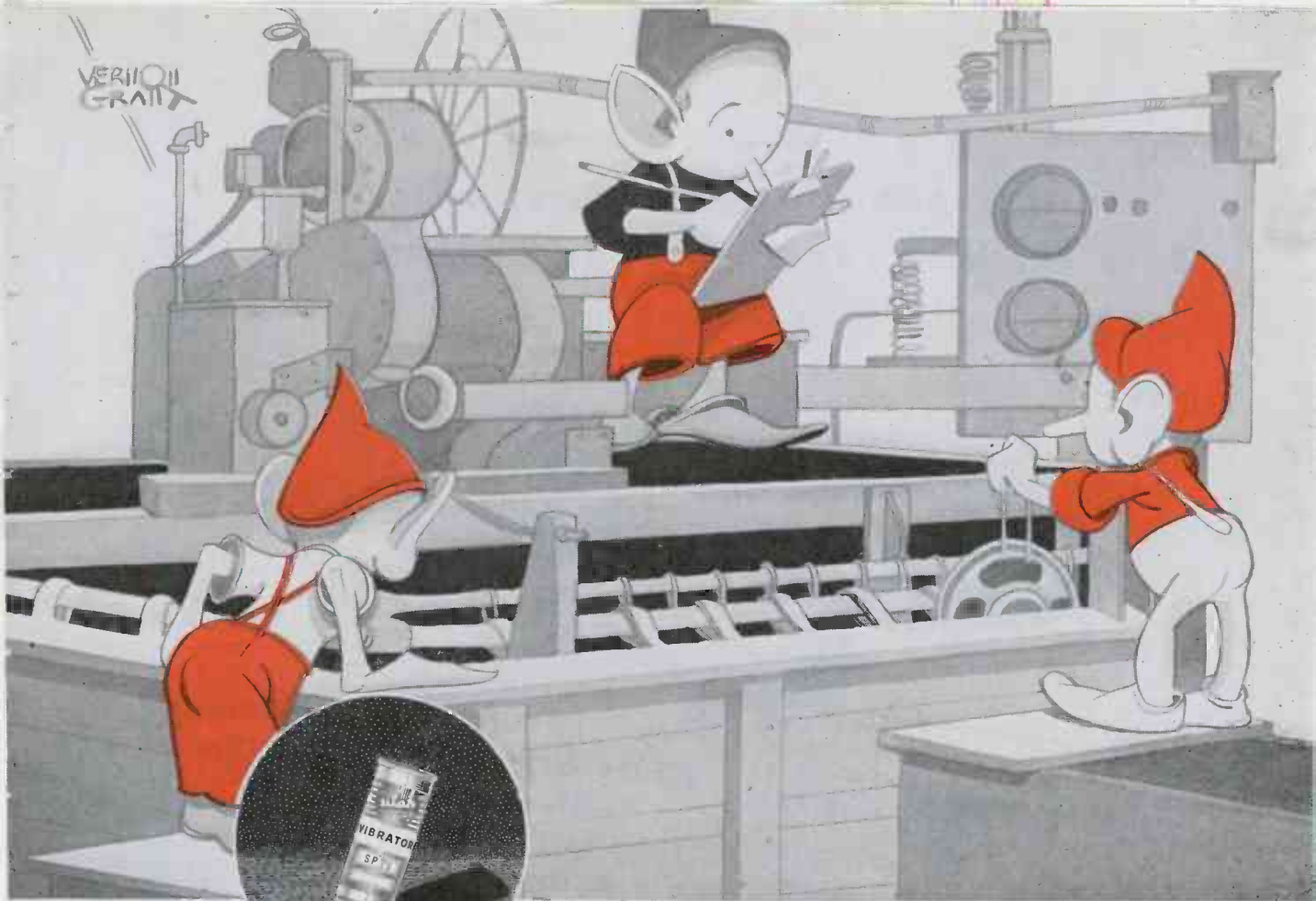

**Every Utah vibrator makes and breaks more than a billion contacts during its lifetime.*

PERFORMANCE . . .

THE PROOF OF UTAH QUALITY



You take for granted the plating process of Utah's radio parts and electronic devices. Just as you would take for granted the Utah loud speakers in manufacturers' sets.

But Utalins* don't. They work on this phase of production as carefully as if they were plating with gold. They know that plating is one of the more important steps in the production of these products of precise manufacture . . . of proven performance. Products that stand up under every known condition.

Utalins* begin with nothing but raw materials. As each step follows in the process of manufacture . . . tool making, welding, punch press, electroplating and all the other steps . . . it's checked, re-checked, tested, supervised. Finally the finished products, shipped from Utah's self-contained factory, prove the Utah method correct. For they speak by performance. **Utah's helpers.*



UTAH RADIO PRODUCTS COMPANY
820 Orleans Street, Chicago 10, Illinois
Utah Electronics (Canada) Ltd.
300 Chambly Road, Longueuil,
Montreal (23) P.Q. • Ucoa Radio,
S. A., Misiones 48, Buenos Aires

**"WE USE EIMAC TUBES EXCLUSIVELY
IN ALL OUR LARGER GROUND STATIONS"**

Says Robert F. Six
PRESIDENT, CONTINENTAL AIR LINES



CONTINENTAL AIR LINES, INC.
MUNICIPAL AIR TERMINAL
Denver 7, Colorado

January 9,
1945

Chief Engineer
Eitel-McCullough, Inc.
870 San Mateo Avenue
San Bruno, California

Dear Sir:

An airline must have a communication system which is absolutely dependable. For that reason, we scrutinize with great care the records we keep on the performance of the various components used in our transmitting and receiving equipment.

Included among these records are those on Eimac transmitting tubes—used exclusively in all of the larger ground stations operated by Continental Air Lines. I am pleased to tell you that these records show that your transmitting tubes are averaging well over 20,000 hours of service in our stations.

Sincerely yours,

Robert F. Six
Robert F. Six
President

RFS/lad



ROBERT F. SIX
President
Continental Air Lines

Below... a pair of Eimac 450-T tubes in the panel of Continental ground station transmitter built by Wilcox.

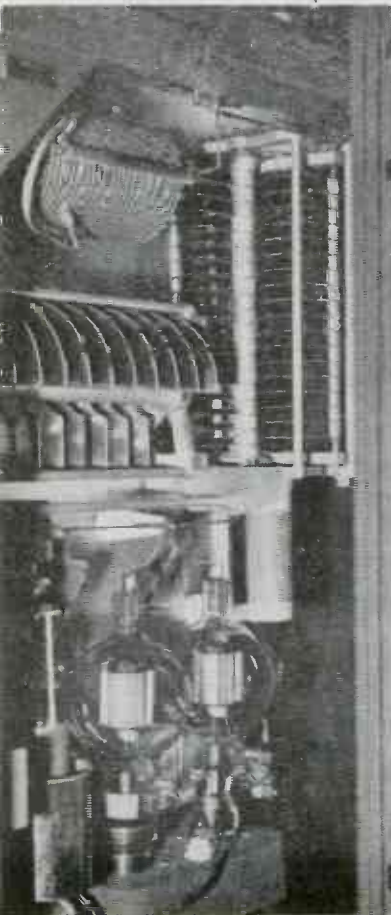

FOLLOW THE LEADERS TO

Eimac
TUBES



Get your copy of *Electronic Telesis*... the sixty-four page booklet which gives the fundamentals of electronics. This little booklet will help electronic engineers explain the subject to laymen. It's yours for the asking... no cost or obligation. Available in English and Spanish languages.

EITEL-McCULLOUGH, INC., 1029 San Mateo Ave., San Bruno, Calif.
Plants located at: San Bruno, California and Salt Lake City, Utah
Export Agents: Frazer & Hanson
301 Clay St., San Francisco 11, California, U.S.A.

Precision Engineered VARIABLE RESISTORS



Space Requirements
for 252 Series and
GC-252 Series

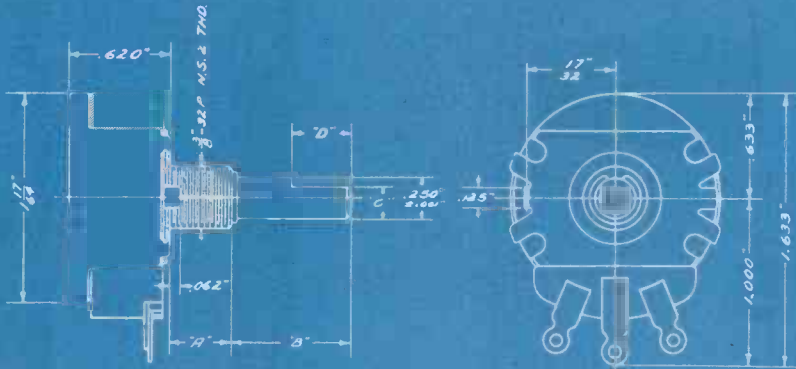

252 SERIES

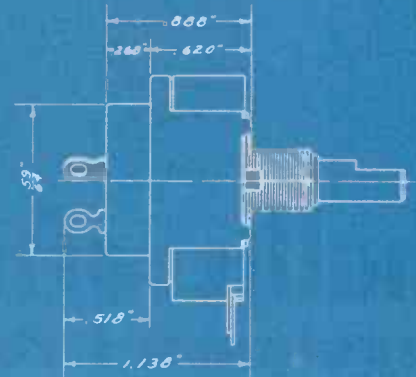

GC-252 SERIES

● Good engineering reduces the element of chance to an absolute minimum. At CTS, every rule of good engineering no matter how slight its application, is strictly adhered to.

Typical of this are the contacts in all CTS variable resistors. Every contact has multiple—and independent—wiping surfaces whose precision workmanship practically

eliminates the chance of faulty contact.

Such engineering craftsmanship has made CTS variable resistors known all over the world for *dependability*.

When your production plans call for new developments in variable resistors, consult these leading specialists—the CTS engineers.

Manufacturers of Quality Electro-Mechanical Components Since 1896

VARIABLE RESISTORS
PLUGS AND JACKS
SWITCHES, RINGERS
TELEPHONE GENERATORS

REPRESENTATIVES

R. W. Farris Co.
406 West Thirty-fourth Street
Kansas City 2, Missouri
Phone: Logan 7495

Frank A. Emmet Co.
2837 West Pico Boulevard
Los Angeles 6, California
Phone: Rochester 9111

BRANCH OFFICES
S. J. Hutchinsan, Jr.
401 North Broad Street
Philadelphia 8, Pennsylvania
Phone: Walnut 5369

IN SOUTH AMERICA
Jose Luis Pontet

Cordoba 1472
Buenos Aires, Argentina
South America

IN CANADA
C. C. Meredith & Co.
Streetsville, Ontario

Masculino 2624
Montevideo, Uruguay
South America

IN ENGLAND
Chicago Telephone Supply Co.
St. John's Woods
103 Grove End Gardens
London, N. W. 8, England

Avda. Conselheiro Rodrigues
Alves 1067
Villa Mariana
Sao Paulo, Brazil
South America

CHICAGO TELEPHONE SUPPLY
Company

ELKHART * INDIANA

CENSORED



Model S-37.



Model S-36.



Model SX-28A.



Model S-22R.

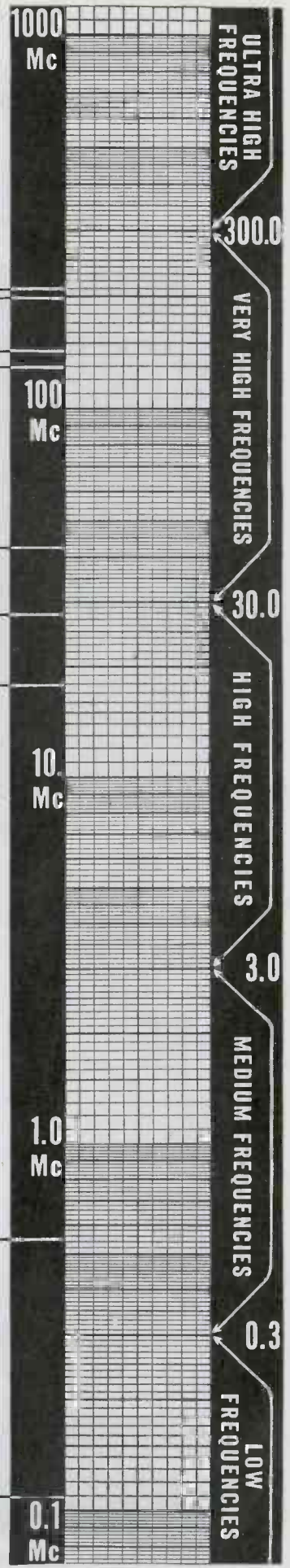

hallicrafters equipment covers the spectrum

● Hallicrafters equipment covers the radio spectrum. From low to ultra high frequencies there is a Hallicrafters receiver ready to meet your special requirements. Although certain equipment operating in the ultra high frequencies cannot be described at present for security reasons, the characteristics of Hallicrafters standard line of receivers may be disclosed. This line includes:

Model S-37. FM-AM receiver for very high frequency work. Operates from 130 to 210 Mc. Highest frequency range of any general coverage commercial type receiver.

Model S-36. FM-AM-CW receiver. Operates from 27.8 to 143 Mc. Covers old and proposed new FM bands. Only commercially built receiver covering this range.

Model SX-28A. Operates from 550 kc to 42 Mc continuous in six bands. Combines superb broadcast reception with the highest performance as a versatile communications receiver.

Model S-22R. Completes Hallicrafters coverage in the lower end of the spectrum. Operates from 110 kc to 18 Mc in four bands. A.c./d.c. operation.

BUY A WAR BOND TODAY!



hallicrafters

THE HALLICRAFTERS COMPANY • MANUFACTURERS OF RADIO AND ELECTRONIC EQUIPMENT • CHICAGO 16, U. S. A.

It's Just A Case of Making the Right Connection

--WHITAKER CUSTOM-MADE
CABLE ASSEMBLIES
are supplied ready to install



Above photo, courtesy of Collins Radio Company, Cedar Rapids, Iowa. It shows installation of a Whitaker Assembly in a Collins TDO Transmitter . . . Illustration at right shows Assembly being made at Whitaker plant.



IF YOUR PRODUCT requires

- ★ WIRING HARNESSSES
- ★ CABLE ASSEMBLIES
- ★ BONDING JUMPERS
- ★ CABLE or TERMINALS

-- you'll find **WHITAKER** a dependable source

You can *save time and money* by having Whitaker produce the cable assemblies required for your products . . . In turning your wiring jobs over to us, you are making the right connection for *quality* merchandise made to exacting specifications, and when your men install the completed assemblies, they will find every lead and terminal properly positioned for the right connection . . . You win both ways . . . Furthermore, you will find your production costs reduced as the

result of utilizing our specialized facilities. You get full benefits of our 25 years of experience, our ample production facilities, skilled manpower, and the economies resulting from our use of modern methods and special equipment.

In addition to an engineered wiring service, Whitaker also offers a quality line of standard cable products.

Write for latest catalog, and complete information.



WHITAKER CABLE CORPORATION

General Offices: 1311 Burlington Avenue, Kansas City 16, Missouri
Factories: Kansas City, Mo. • St. Joseph, Mo. • Philadelphia • Oakland

101 SERIES

Amplifiers

WITH RACK PANEL OR WALL
MOUNTING ACCESSORIES



Input impedance 600 ohms and bridging. Gain 600 ohm input 61 db., bridging input 46 db. Frequency response 30 to 16,000 c.p.s. either input—600 ohm output ± 0.5 db., 30 ohm output ± 1 db. Power output—production run average: +47 V.U. with less than 3% RMS harmonic content.



TYPE 201-A Wall Mounting Cabinet permits universal installation of 101 Series Amplifiers to any flat surface. Well ventilated and designed for maximum accessibility for servicing and convenience of installation. Standard aluminum gray finish.



TYPE 7-A Modification Group permits 101 Series Amplifiers to mount on standard 19" telephone relay racks. Occupies 12 1/4" rack space. Allows servicing from front of rack. Standard aluminum gray finish.

THE TYPE 101 Series Amplifiers are the results of twenty years' experience in the sound engineering field. They are identical with the exception of the output coil.

Type 101-A has output impedance adjustments to match loads from 1 to 1000 ohms and possesses excellent low frequency waveform at high output levels.

Type 101-B with a single nominal 6 ohm output is intended for use with wide range loudspeakers representing an 8 to 16 ohm load. Its output coil with a single secondary provides improved efficiency and even better waveform at high levels of low frequencies.

Type 101-C answers the demand for a good amplifier at lower cost. This lower cost is obtained by the use of a less expensive output coil with the only change being that the low frequency waveform is not as good as the A or B types but is equal to or better than any contemporary commercial amplifier. Output impedance is adjustable to loads of 1 to 1000 ohms.

The Langevin Company

INCORPORATED

SOUND REINFORCEMENT AND REPRODUCTION ENGINEERING

NEW YORK

SAN FRANCISCO

LOS ANGELES

www.americanradiohistory.com

Where Life HANGS BY A THREAD

A maze of dials, recording the heart-beat and vital functioning of the giant war-plane; behind each dial, delicate mechanisms that react instantly to inform the pilot of the plane's speed, altitude, bearing . . . outside temperature, wind, humidity . . . *and every mechanism dependent upon machined precision in the tiny screws and screw machine parts!* Literally, the life of the plane and its crew hangs by the *thread* and the precise dimensions of those parts . . . which are products of intricate automatic screw machines, such as have been de-

signed and perfected through the past 51 years by this company.

Makers of electronic units may look to Waltham Screw Company for fine screws and screw machine products, in whatever quantity is required. Modern production methods, plus cumulative experience of three generations in the screw machine products field, combine in this technical plant to furnish the electronics industry with special screws of any design, thread, head style, length, material and finish.

THREE GENERATIONS OF INGENUITY AND SKILL

WALTHAM SCREW COMPANY

77 Rumford Ave.,
Waltham, Mass.

CONTROLS FOR WORLD MARKETS



Ward Leonard Controls have an enviable record of performance in war equipment. On the sea, under the sea, on the ground, and in the air — subjected to widely varying climatic conditions in all parts of the world!

Obviously manufacturers who are planning world-wide postwar markets can be certain that the Ward Leonard controls they incorporate in their products will give continuous trouble-free service.

Write for our catalogs describing the types of controls you need.

WARD LEONARD

RELAYS • RESISTORS • RHEOSTATS



Electric control  devices since 1892.



RELAYS—light, intermediate and heavy duty.

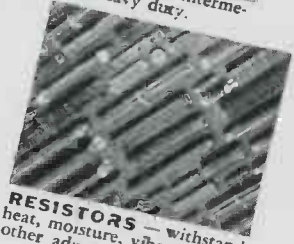

RESISTORS—withstand heat, moisture, vibration and other adverse conditions.



RHEOSTATS—wide range of sizes, types and current ratings from ring types to industrial assemblies.

When insulator design calls for Quick Action

DEPEND ON



When time is of the utmost importance the ease and precision with which Mykroy can be fabricated into insulator parts makes it exceptionally useful to electronic and electrical engineers. Make those design changes on the spot . . . make them quickly and economically with Mykroy, for, here is a ceramic which can be worked in your own shop. Just transfer your design to the Mykroy sheet . . . then using conventional shop tools . . . produce the desired part by simple cutting, grinding, drilling, tapping and polishing techniques.

Because it has high structural strength and physical stability Mykroy can be machined to critical tolerances more readily than other types of ceramics. In addition, its electrical characteristics are of the highest order and do not shift under any conditions short of actual destruction of the insulation itself. This, plus excellent chemical and physical properties, makes it one of the best insulating materials ever developed for general and high frequency applications.

Get the full facts about this versatile dielectric now. Ask for a copy of the new MYKROY BULLETIN 102, which describes the new larger (19 1/4" x 29 3/4") sheet now available and call upon our engineers to help with your problems.



A representative group of parts fabricated in Mykroy to customer's specifications in our own plant. We have complete facilities to produce such parts in any quantities on rapid delivery schedules. Send us your specifications.

MECHANICAL PROPERTIES*

MODULUS OF RUPTURE.....	18000-21000psi
HARDNESS	Mohs Scale 3-4 BHN. BHN 500 K9 Load. 63-74
IMPACT STRENGTH.....	ASTM Charpy .34-.41 ft. lbs.
COMPRESSION STRENGTH.....	42000 psi
SPECIFIC GRAVITY.....	2.75-3.8
THERMAL EXPANSION.....	.000006 per Degree Fahr.
APPEARANCE.....	Brownish Grey to Light Tan

ELECTRICAL PROPERTIES*

DIELECTRIC CONSTANT.....	6.5-7
DIELECTRIC STRENGTH (1/2").....	630 Volts per Mil
POWER FACTOR.....	.001-.002 (Meets AWS L-4)

*THESE VALUES COVER THE VARIOUS GRADES OF MYKROY

- GRADE 8. Best for low loss requirements.
 - GRADE 38. Best for low loss combined with high mechanical strength.
 - GRADE 51. Best for molding applications.
- Special formulas compounded for special requirements.

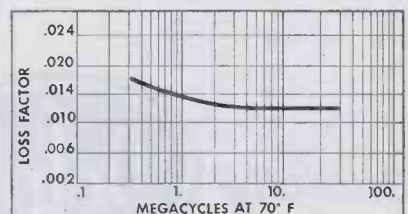

Based on Power Factor Measurements made by Boonton Radio Corp. on standard Mykroy stock.

MADE EXCLUSIVELY BY

ELECTRONIC MECHANICS INC.

70 CLIFTON BLVD., CLIFTON, N. J.
CHICAGO 47; 1917 N. Springfield Ave., Tel. Albany 4310
EXPORT OFFICE 89 Broad Street, New York 4, New York

MYKROY IS SUPPLIED IN SHEETS AND RODS — MACHINED OR MOLDED TO SPECIFICATIONS

PG-4 PX-5 Synthite* 223

*Synthite** . . . a trade name that is gaining more and more recognition throughout the electrical industry, can be furnished in both air drying and baking type varnishes, all formulated to give you more uniform and efficient production. These polymerizing types of varnishes provide a heavier build-up than most conventional grades, affording a high degree of resistance to oil, water, acids and alkalis. There is a grade of DOLPH'S SYNTHITE that will do a better insulating job for you.

Write us today for further information and let our Laboratory and Service Engineers assist you in your insulating varnish problems, without any obligation on your part.

* REG. U. S. PAT. OFF.

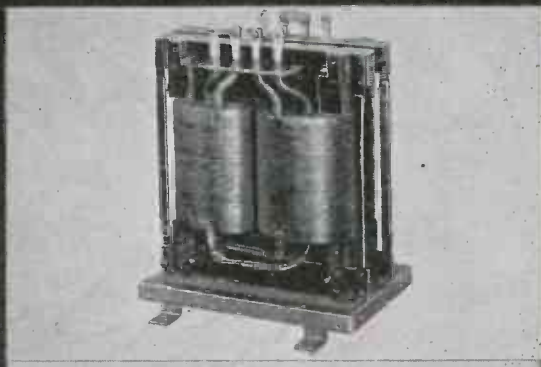

PG-4 A Clear Bak ing Varnish with excellent oil resistance. Thermosetting and possessing a high dielectric strength, this varnish can be thinned with VM&P Naphtha (Benzine) and does not require any special solvent.



PX-5 A Back Bak ing Varnish adaptable to all types of electrical units, suitable for Formvar, Formex and glass coated wire. Degree of hardness can be regulated by the bak ing time.

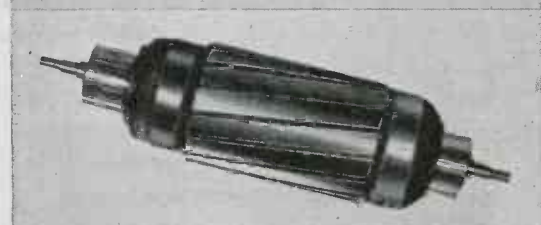

223 A Clear Bak ing Varnish which provides exceptional bonding properties and heat resistance, making it ideally suited for high speed windings. The hardness of this material permits ease in machining.

Insulating **Dolph's** Varnish Specialists
JOHN C. DOLPH COMPANY

168 EMMETT STREET • NEWARK 5, N. J.

ELECTRONIC INDUSTRIES • April, 1945



"HE WAN'STA KNOW
WHY THEY CALL THIS
THA' PACIFIC
THEAYTER"

WHAM!

SWISH

ZING



Fine instruments produced in volume with quality first . . . to last.

Triplett



ELECTRICAL INSTRUMENT CO.
BLUFFTON, OHIO

A L L C L E A R !

"All clear" is a welcome greeting

when returning from a sortie.

As one of our DFC boys puts it:

"*Going* on twenty-five missions is a tough job—

but it's getting *back* to the base that counts."

... Super-Pros are on the job every minute with the AACS.



THE HAMMARLUND MFG. CO., INC., 460 W. 34TH ST., N.Y.C.
MANUFACTURERS OF PRECISION COMMUNICATIONS EQUIPMENT



Direct hammering of armature windings is not a G-E practice, nor do we recommend it, but it's typical of abuse that may occur without appreciable damage to FORMEX.

WHEN
MAGNET WIRE

Must take the RAP!

FORMEX* helps keep down rejects—lowers cost of completed windings.

Few operations put magnet wire to a tougher test than bench assembly of armatures and stators. And rough treatment is intensified by today's push for high production despite high labor turnover.

Because of its exceptionally tough and flexible insulating film, FORMEX magnet wire can take a lot more such abuse than conventional enameled wire. When coils are being wound, bonded, baked, formed, or handled, this extra toughness (and extra resistance to heat-shock and solvents) helps to reduce rejects without requiring "babying" techniques.

As the world's largest user of magnet wire, General Electric makes the same sort of comparisons of installed costs as you might make. These comparisons show that, even in those few cases where the cost of Formex may be slightly higher than the cost of conventional magnet wire which it replaced, the higher first cost is definitely offset

by lower costs of manufacturing the completed coil or installed winding. In addition, the choice of Formex for new designs permits more compact windings, which, in turn, save space, copper, and frame materials.

Why not, right now, ask your G-E representative for complete information and samples of Formex wire. General Electric Company, Schenectady 5, N. Y.

Round wire sizes: No. 8 Awg to .001 in.
Rectangular wire: Full range of sizes

Buy all the
BONDS you
can—and
keep all
you buy



*Trade-mark
Reg. U.S. Pat. Off.

GENERAL  ELECTRIC

503-22-1200



**What's
Going on
Here?**

The *what* we can tell you about. The *how* is one of those many little secrets about instrument manufacture Simpson has learned through more than 35 years of experience. This particular operation has to do with the making of pivots, those critical parts around which the accuracy of any electrical instrument revolves. Only by means of this and other Simpson-developed processes can we make pivots which in strength and hardness, and in their perfect contour, measure up to Simpson's standard. The Simpson plant is full of such refinements and shortcuts—all aimed at the twin purpose of improving performance and reducing cost. Added to the basic superiority of the patented Simpson movement they provide the fullest measure of accuracy and stamina, and dollar value. Only Simpson's long familiarity with the problems of instrument manufacture could achieve so many noteworthy solutions. Nothing less can promise so much for the electrical instruments and testing equipment you will use in the years to come.

SIMPSON ELECTRIC CO.
5200-18 W. Kinzie St., Chicago 44, Ill.

Simpson
INSTRUMENTS THAT STAY ACCURATE



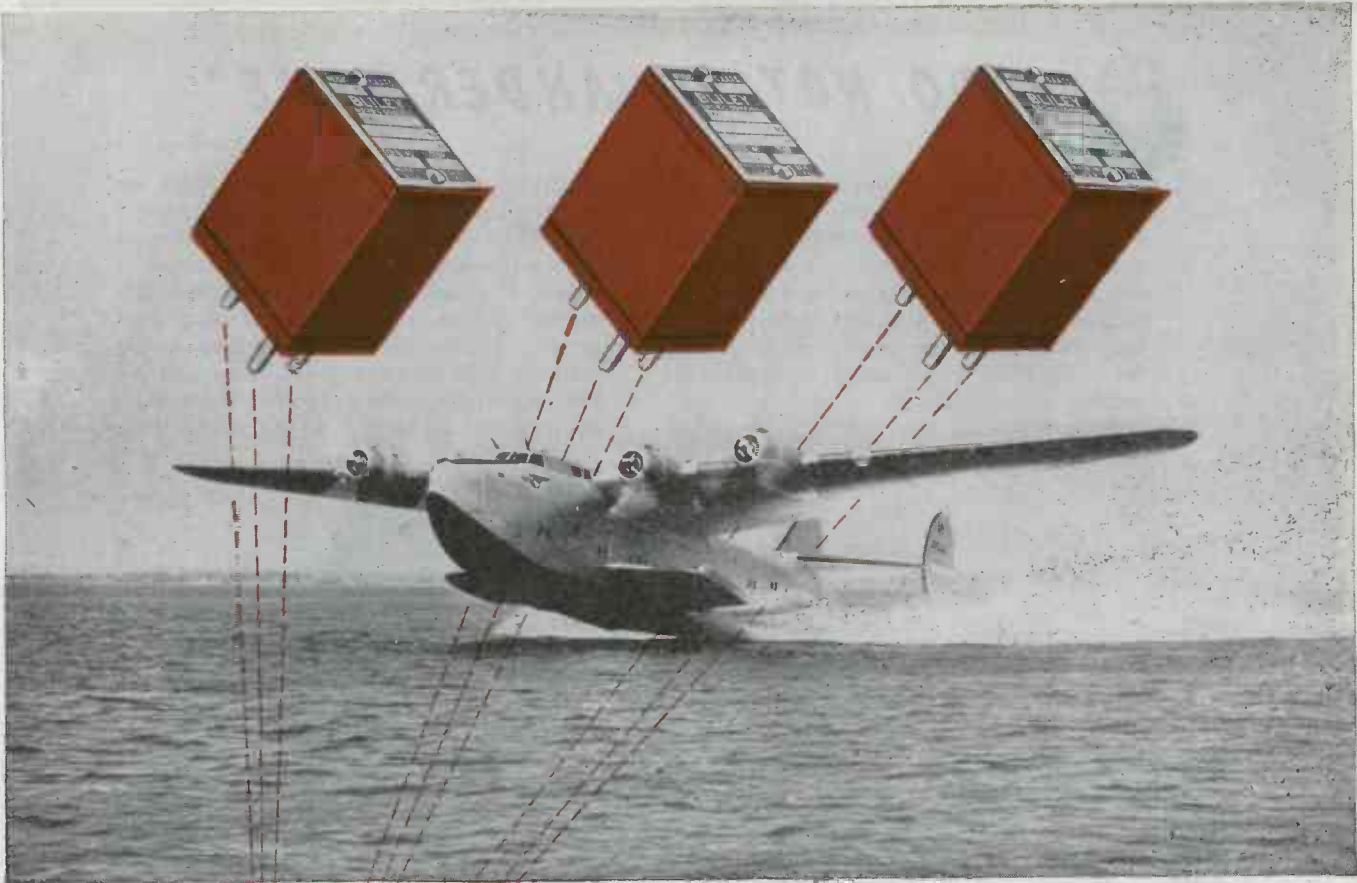

BLILEY CRYSTALS, of course, fly with Pan American



Bliley *acid etched** crystals persistently show up wherever there is an important communications job to be done such as the combination two-way telephone and telegraph and range finder systems of Pan American World Airways. In peace and in war Bliley crystals have flown millions of world-wide miles with their famous Clippers.

Bliley crystals are pre-conditioned for just such rugged assignments. In the Bliley Electric Company plant there is a large section where Bliley

*acid etched** crystals receive their pedigree. Here each crystal gets "the works". Its activity and frequency are *proved* under tough laboratory created service conditions of altitude, humidity, temperature, immersion, shock and vibration.

But licking tough assignments is a tradition with Bliley engineers and craftsmen. This background of research and skill has been responsible for the distinguished record of Bliley Crystals in every field of radio communication. Whatever your crystal problem may be—specify Bliley.

+ + +

**Acid etching quartz crystals to frequency is a patented Bliley process. United States Patent No. 2,364,501*

☆ A new star has been added



Bliley CRYSTALS

Do more than before . . .
buy extra War Bonds



"DO NOT SQUANDER TIME"

... Benjamin Franklin

At Connecticut Telephone and Electric Division, production is unhurried, as it must be to maintain accuracy and quality in precision electrical and electronic manufacturing. We substitute *time-saving* methods for *hustle and bustle*. This has enabled us to keep abreast of the ever-increasing need for military communicating equipment of uniform dependability.

After the war, you will very likely use

electrical equipment, electronic devices, or communicating systems made at Connecticut Telephone and Electric Division... Or you may be one of the many manufacturers who will use our engineering and manufacturing facilities in connection with your own products... In either case, our time-saving methods will be your gain, measured by the important standards of uniform high precision, and speed of filling your orders.

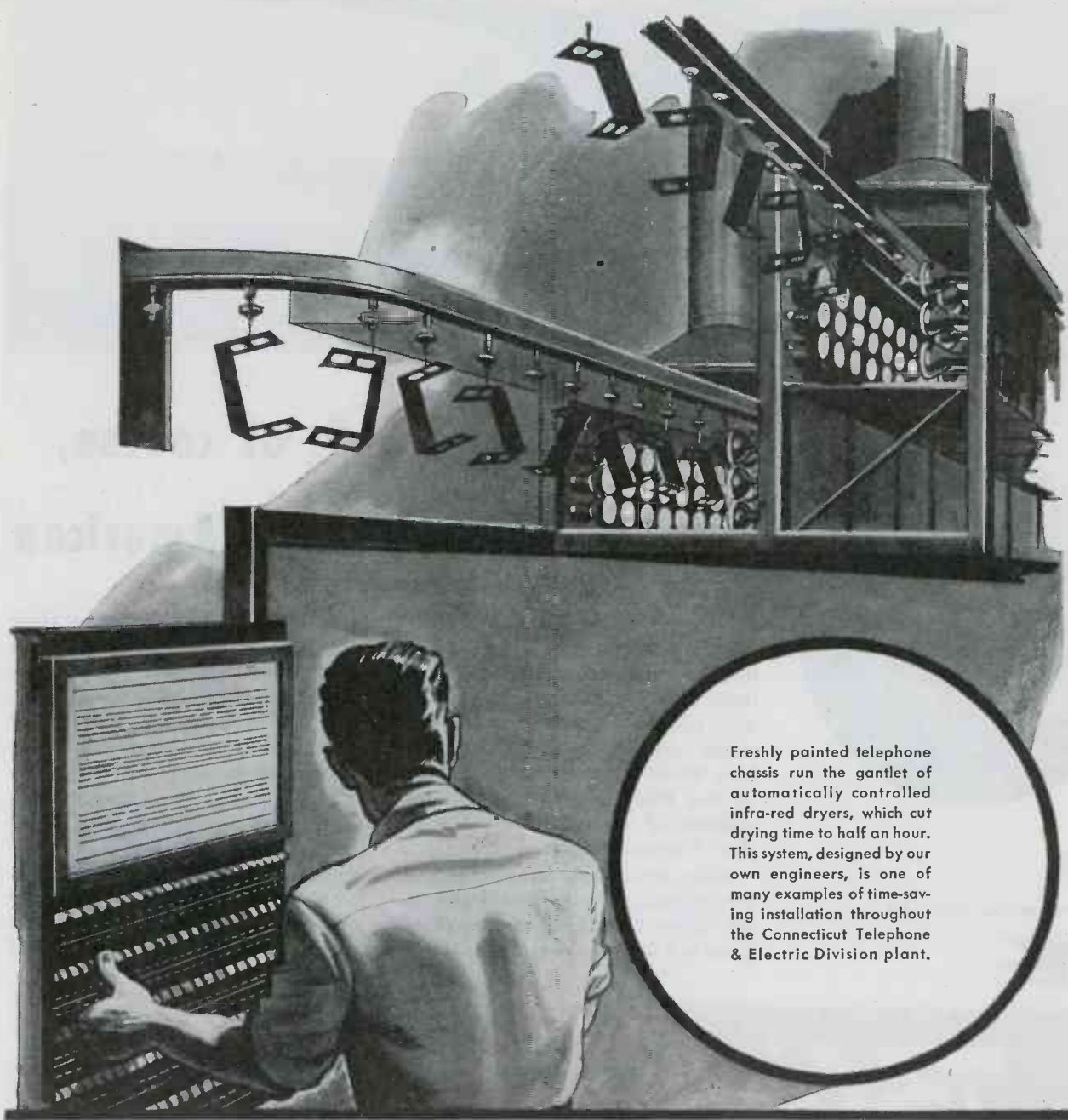

Freshly painted telephone chassis run the gantlet of automatically controlled infra-red dryers, which cut drying time to half an hour. This system, designed by our own engineers, is one of many examples of time-saving installation throughout the Connecticut Telephone & Electric Division plant.



CONNECTICUT TELEPHONE & ELECTRIC DIVISION

GREAT AMERICAN INDUSTRIES, INC. • MERIDEN, CONNECTICUT

MEC-RAD

ELECTRONIC COMPONENTS
SERVE ON OUR NAVY'S
NEWEST AND FINEST
BATTLESHIPS



Official U. S. Navy Photograph

As the new giants of the U. S. Navy leave the ways for their history making battle missions, among their most essential equipment are electronic devices. Mec-Rad's entire productive capacity is now devoted to the manufacture of vital mechanical and electro-mechanical components for these electronic units.

Our work includes "fancy brass plumbing" of all types involving soft and hard soldering, close tolerances, precision machining, careful assembly and finishes ranging from lacquer to silver and rhodium plating.

After the war our specialized facilities will be available to the electronic industry for peacetime needs. You can use our engineering "know-how" based on years of experience in this field, for planning your post-war products today.

Bow-on view of the U.S.S. IOWA, archetype of the Navy's newest class of battleships.



MEC-RAD

DIVISION-BLACK INDUSTRIES

1400 EAST 222ND STREET ☆ CLEVELAND 17, OHIO



Type C-7220 Precision Snap Switch
12 amps. 30 Volts D. C., 125 Volts A. C.



Type C-2851 Thermostat. For such use as
Roughing Controls on Outer Crystal Ovens



Type C-4351 Thermostat. Used for Tube
Warming, Tube Cooling, High Limit Controls,
etc.



Type PM (NAF-1131) Circuit Breaker



Type RT Thermostat. Adjustable Temperature
Control



Type ER Series. Ambient Compensated Time
Delayed Relays



Type B-3120 Thermostat and Heater, Crystal
Dew Point Control

PQ 'S AND 'S

of Reliable Control or Protection...

- . -

KLIXON DISC-OPERATED CONTROLS

Simplicity of operation is the reason for the accurate operation of Klixon Controls. These compact, light-weight controls are actuated by a simple scientifically calibrated Spencer thermostatic disc. This foolproof actuating element does away with complicated relays, toggles, magnets and other fussy parts that tend to wear and get out of adjustment. It provides sure operation by snapping to a quick clean break or a solid make . . . no matter how often it operates. And because there's nothing to get out of order, its accurate performance is unaffected by motion, altitude, vibration or shock regardless of the position of mounting.

Klixon Controls are available in a wide range of types and sizes for such applications as motor and transformer overheat protection, electric circuit overload protection, thermal time delays or temperature control for radio equipment. Investigate Klixon Controls for reliable control or protection applications. Complete information sent on request.



"Have You Heard About the Big War Job They're Doing at Bridgeport?"

"You Bet I Have! And They'll Be Able To Do Just As Good A Job For Us After the War... I've Already Placed our Coil Business With Bridgeport."

**YES,
BRIDGEPORT
WILL DO
A BIG
POSTWAR
JOB**

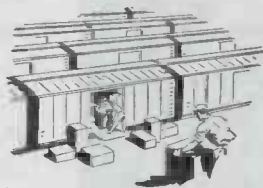

Right now, Bridgeport is turning out search coils and variometers in the huge quantities necessary to meet the needs of the armed forces, and with the quality required by exacting military specifications. That same capacity and skill will be brought to bear on your postwar orders.

Bridgeport's central location, right near the population center of America, gives you the added advantage of fast, trunk line delivery service to any point. Write to us **TODAY** to insure early postwar delivery of R.F. Coils and Chokes, I.F. Transformers and Transmitting Coils and Chokes.

BRIDGEPORT

MANUFACTURING COMPANY
Bridgeport, Illinois

R. F. Coils • R. F. Chokes • I. F. Transformers
Transmitting Coils • Transmitting Chokes

EYES work better
with the personally-
fitted lighting of

DAZOR
Floating
LAMPS

Many of your workers are handicapped by defective vision. You *can't* give them better eyes but you *can* help balance sight inequalities with Dazor *Floating Lamps*: flexible, *localized*, high intensity lighting which provides an *individual fit* for each operator. And easy does it! Fingertip

pressure *floats* the Dazor to any desired position, where it *stays put*—without locking or tightening—until moved elsewhere. This is due to a patented enclosed spring force which balances the arm automatically.

Whether for eyes old or young, sound or defective, Dazor *Floating Lamps* make seeing easier on all jobs requiring concentrated and prolonged vision: precision machine work, inspection, fine assembly, and drafting. They help increase output, reduce spoilage, minimize fatigue, promote safety and increase profits.

Call Your Dazor Distributor

For complete information, experienced application assistance and a practical on-the-job demonstration, phone one of the Dazor-appointed distributors in your locality. Their names, if unknown to you, can be secured by writing to the Dazor Manufacturing Co., 4483 Duncan Ave., St. Louis 10, Mo.

IN CANADA address all inquiries to Amalgamated Electric Corporation Limited, Toronto 6, Ontario.

MOVES FREELY INTO ANY POSITION



STAYS PUT WITHOUT LOCKING

DAZOR *Floating* **LAMPS**

FLUORESCENT and INCANDESCENT

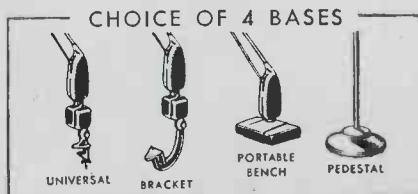

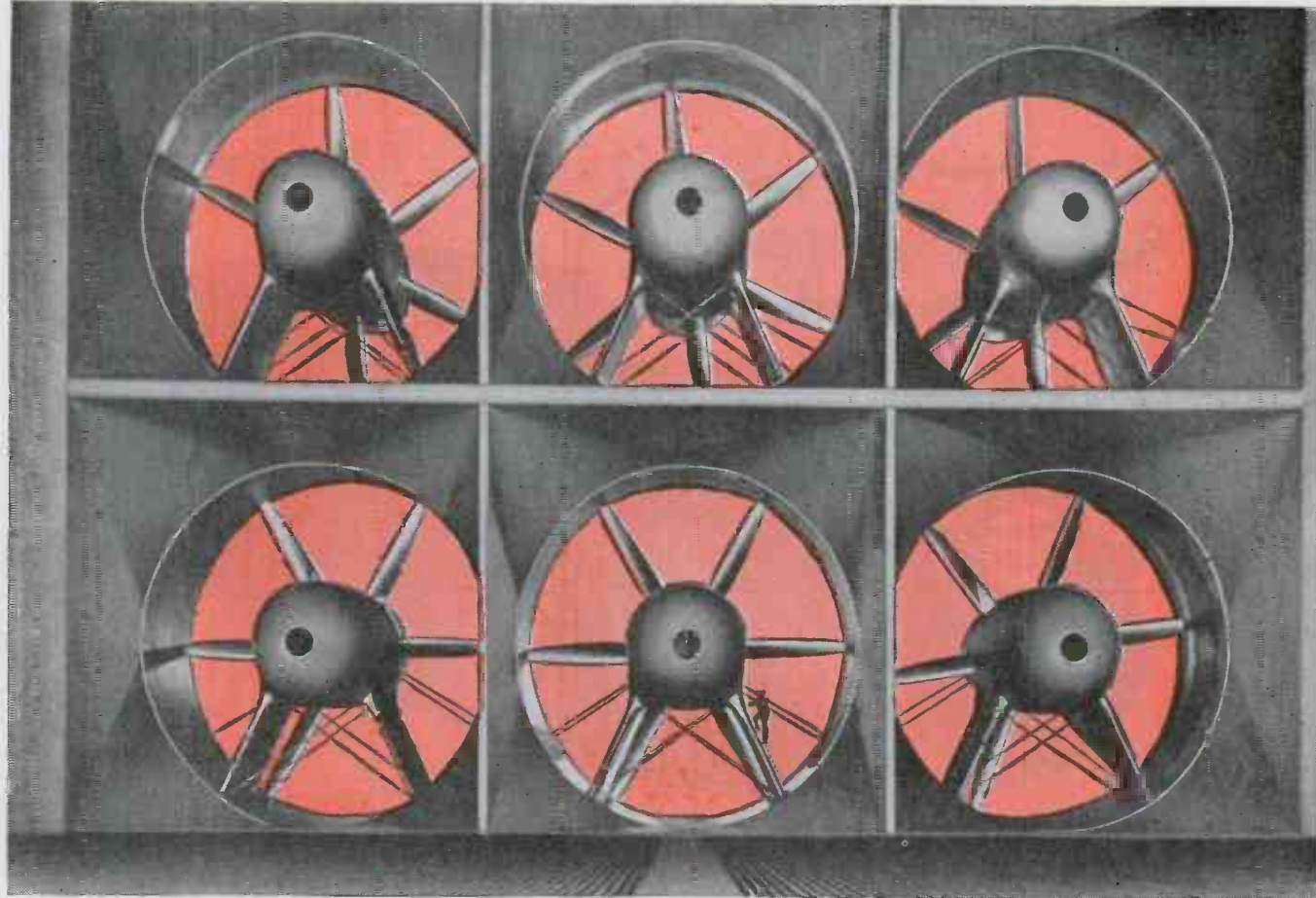

how to tame 36,000 horsepower

Above you see the six giant propellers for one of Uncle Sam's mighty new wind-tunnels — where NACA research engineers are working out the designs for still faster and higher-flying planes.

Driving these 40-foot propellers are six 6000 hp motors, each weighing 57 tons. And in spite of the size of the motors, the complicated system of exciters, generators, spinning shafts and whirling propellers—the speed of each motor must be held to extreme accuracy.

By making a complete study of the system, Westinghouse engineers were able to determine the proper regulator system to do the job. It turned out to be the small, compact electronic regulator

shown at the right. By responding to minute changes in speed, it automatically makes the necessary adjustments—compensating for any fluctuations in power supply or changes in load. Thus, through the delicate sensitivity of electronic tubes, it is possible to tame 36,000 hp.

Accurate speed and voltage regulation is just one of the many practical applications of electronics perfected to meet wartime demands. You may want to know more about this or other electronic developments for your industry. Your nearest Westinghouse office is ready to provide full information . . . or write to Westinghouse Electric & Mfg. Co., P.O. Box 868, Pittsburgh 30, Pa. J-91071

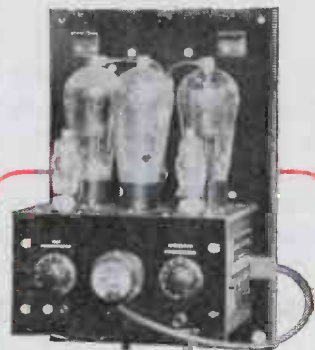

THE ELECTRONIC REGULATOR

Through the sensitivity of electronic tubes, this device accurately regulates the speed by controlling the voltage on the "running" generator, despite fluctuations in power supply or changes in load. It has wide applications in continuous process industries, wherever accurate control of machine speed is essential to uniformity of product.



Westinghouse
PLANTS IN 25 CITIES . . . OFFICES EVERYWHERE

TUNE IN JOHN CHARLES THOMAS, SUNDAY—2:30 EWT, NBC.
HEAR TED MALONE, MON. TUES. WED. EVENINGS, BLUE NETWORK.

Electronics at Work

ELECTRONIC EQUIPMENT FOR INDUSTRY AND HOME • ELECTRONIC TUBES • RADIO AND TELEVISION

ELECTRONIC INDUSTRIES • April, 1945

www.americanradiohistory.com

"The following is electrically transcribed..."

"Super Suds, Super Suds,
lots more suds..."

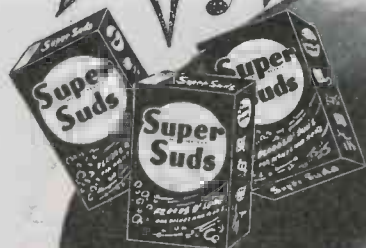

on **PRESTO** discs!

To any modern youngster or her Mommy, the Super Suds jingle is as familiar as the works of Mother Goose. In two years, this merry snatch of song has proved itself a commercial with "super-do"—lilting its way into the musical memory of America, and, incidentally, selling a whacking big heap of suds.

Super Suds "spots" are cut on PRESTO discs.

Most important transcriptions are. For recording engineers know that PRESTO discs give finer results with less margin for error—*actually perform better than most of the recording equipment on which they are used.* That's why you'll find, in most large broadcasting stations, recording studios and research laboratories, the standard recording disc is a PRESTO.

WHY BROADCASTING STUDIOS USE MORE PRESTO DISCS THAN ANY OTHER BRAND



Less Surface Noise



No Distortion

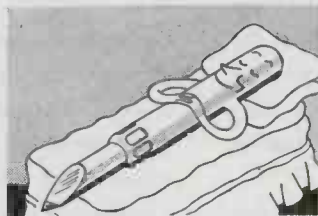

Easier on Cutting Needle



No Fussy Needle Adjustments

WORLD'S LARGEST MANUFACTURER

OF INSTANTANEOUS SOUND

RECORDING EQUIPMENT

AND DISCS

PRESTO

RECORDING CORPORATION

242 West 55th Street, New York 19, N. Y.

Walter P. Downs Ltd., in Canada

ELECTRONIC INDUSTRIES • April, 1945

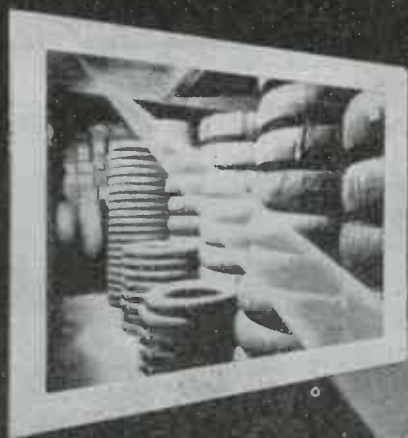

How to make a beam of light scream "FIRE!"

Fire protection by means of Luxtron* photocells employs a steady source of light. When blocked by smoke or deflected by smoke particles, it decreases or increases the flow of current from the cell and activates the entire protection system. . . . By using Luxtron photocells, light can be converted to electric energy, sufficient to operate meters and meter

relays without costly bulky amplifiers, and with assurance of long life under strenuous conditions.

Photocells today are doing everything from calmly watching batches of textiles for perfect color match . . . to sitting undismayed on roaring machinery, stopping it when trouble is in sight. To learn if photocells can help you, write Bradley Laboratories.

Another Bradley Development



This is one of a unique group of "Coprox" (copper oxide) rectifiers developed and manufactured by Bradley with the same understanding of electrical circuits that goes into Luxtron photocells. Write for illustrated "Coprox" bulletin.

*T. M. REG. U. S. PAT. OFF.

PHOTOCELLS—MASTERS OF LIGHT

BRADLEY

MASTER OF PHOTOCELLS

BRADLEY LABORATORIES, INC., 82 MEADOW STREET, NEW HAVEN 10, CONNECTICUT

ELECTRONIC INDUSTRIES • April, 1945

LM

An exceptionally sturdy type only 57/64" in diameter for low-wattage requirements. Has positive-contact spiral spring to eliminate sliding contact between rotor arm and center terminal. With switch: Type LMD.

LP

A larger type, 1-3/32" in diameter for use where voltages do not exceed 350V, and where wattages are .4-watt or less. Can be supplied with sealed cover. Has positive spiral spring contact. With switch: Type LPD.

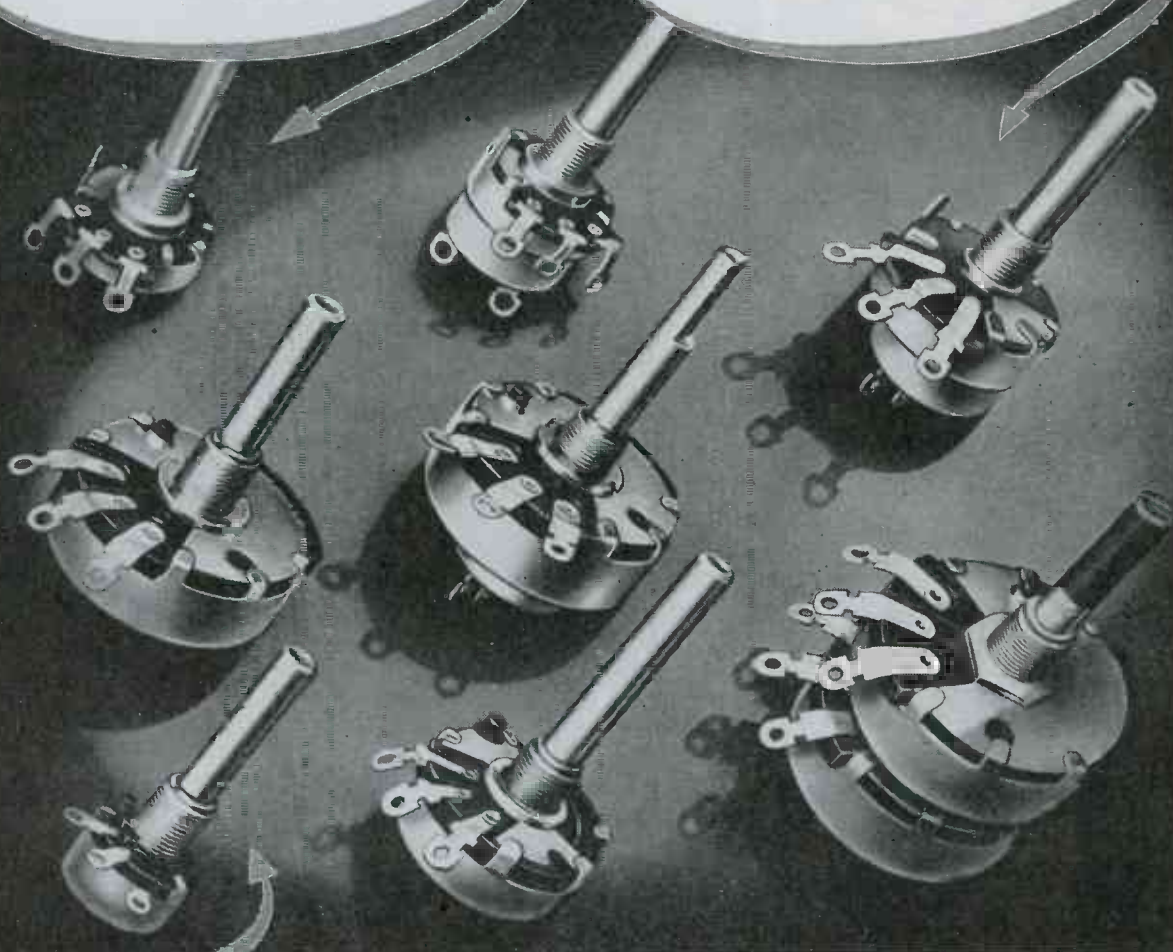
**PSM
MIDGET**

Only 23/32" in diameter—unexcelled for low-wattage uses where size and weight are important factors. Widely used in hearing-aid devices and similar equipment.

STACKPOLE VARIABLE RESISTORS

(Volume, Tone Controls, etc.)

WHAT DO YOU NEED IN CARBON?

BRUSHES — CONTACTS

(All carbon, graphite, metal and compositoin types)

IRON CORES RARE METAL CONTACTS

WELDING CARBON PRODUCTS

PACKING, PISTON and SEAL RINGS

RHEOSTAT PLATES and DISCS

BATTERY CARBONS POWER TUBE ANODES

SPECTROGRAPHITE No. 1, etc., etc.

Tested, tried, and proved in all types of equipment calling for units of this sort, Stackpole Variable Resistors offer maximum dependability under all conditions of use. The line is sufficiently broad to meet all requirements up to ratings of 2 watts. Large, medium and midget sizes—with or without switches—high insulation types—standard, sealed, or insulated shafts—standard and water- and dust-proof covers—friction rotor types, and various others.

Write for **ELECTRONIC COMPONENTS CATALOG—RC6**

STACKPOLE CARBON COMPANY, ST. MARYS, PA.



HOLD THAT TIGER!

A few curt words whispered into the mouthpiece of a "handy-talkie" directs a deadly hail of mortar shells upon a stalking Tiger tank. Insurance against failure in crucial moments is the precision wire that serves as the arteries of American communication equipment at the fighting fronts.

★★★★★

SPENCER
Precision
WIRE ★★

FINE STEEL AND ALLOY WIRE

Spencer Wire Company
WEST BROOKFIELD PLANT
WEST BROOKFIELD • MASS.

It must be made of

Steatite

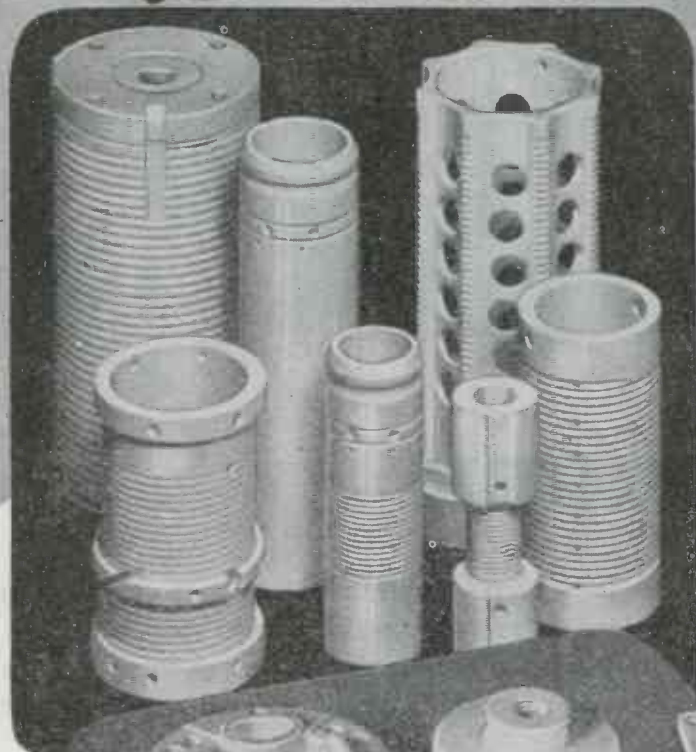

WHETHER in the field of communication (high and ultra-high frequency) or in the various industrial electronic fields, there is no substitute for Centralab Steatite.

There are no other materials that can be made in as many varied forms and shapes as Steatite. Our engineering and laboratory facilities are at your disposal.

Producers of VARIABLE RESISTORS
—SELECTOR SWITCHES—CERAMIC
CAPACITORS, FIXED AND VARIABLE
— STEATITE INSULATORS —
AND BUTTON-TYPE SILVER MICA
CAPACITORS.



Centralab



Division of GLOBE-UNION INC., Milwaukee





Effective April 1st.

All shipments of IRC Type
BT and BW resistors will be

FUNGICIDE TREATED



INTERNATIONAL RESISTANCE CO.

Dept. 2-D

401 NORTH BROAD STREET, PHILADELPHIA 8, PA.
IRC makes more types of resistance units,
in more shapes, for more applications,
than any other manufacturer in the world.

Exclusively

FOR ENGINEERS WHO ARE LOOKING AHEAD!

Where and How Might this Class C High-Temperature Wire Insulation Fit into Your New Product Planning?

Sprague *CEROC 200 is an inorganic wire insulation having outstanding space factor and high-temperature advantages:

- Applied to copper, nickel, or other types of wire, it permits continuous operation at 200°C.
- Wound in coils, the thermal conductivity of *CEROC insulated wire is such that it does not develop hot spots to a point of nullifying much of the high-temperature gain which might otherwise be expected.
- *CEROC 200 has an exceptionally high space factor as the ceramic coating is only one quarter of a mil thick and is uniform for all wire sizes.

Sprague *CEROC 200 is by no means a new or untried development. Pioneered and perfected by Sprague several years ago, it has been supplied exclusively and in large quantities for war applications. Its *proved* advantages are these:

- Substantial volt-ampere rating increases can be obtained.
- Thimble-size coils can be wound to do spool-size coil jobs.
- Throughout the entire field of insulated wire wound electrical devices, countless opportunities exist for re-designing and re-rating products for greater efficiency in smaller sizes and at higher temperature operation.

Wire insulated with *CEROC 200 can normally be supplied in sizes to meet almost any coil, transformer, or motor need. Although practically 100% of the present greatly expanded production is still going for war uses, samples of several popular sizes are available in "engineering" quantities. These represent a real opportunity to those who recognize the tremendous design advantages inherent in this unique insulation development, and who seek to test it, not so much for existing products but in relation to entirely new or re-designed products that look to the future.

Write today for copy of *CEROC 200 Bulletin 505

SPRAGUE ELECTRIC COMPANY
NORTH ADAMS, MASSACHUSETTS

SPRAGUE

PIONEERS IN ELECTRIC-ELECTRONIC PROGRESS

*Trademark Reg. U. S. Pat. Office





from **MIDGETS** to **GIANTS**

AS A TOP producer of radio and electron tubes, National Union makes hundreds of types—from thumbnail miniatures to giant cathode-ray, transmitting and power tubes.

From National Union Research Laboratories have come an impressive number of entirely new types of tubes with special characteristics to meet new requirements, particularly in the ultra-high frequency regions. N. U. scientists have developed new materials . . . for example, new cathode

coatings for high emission efficiency. They have devised new precision manufacturing methods to produce quality tubes in quantity—fast! They have created new standards for tube performance and useful life under rigorous battlefield conditions.

After the war, you will want tubes like these, which embody advanced scientific techniques . . . more efficient, longer lasting tubes engineered to your new needs. Count on National Union.

NATIONAL UNION
RADIO AND ELECTRON TUBES
NATIONAL UNION RADIO CORPORATION • NEWARK 2, N. J.





These are the reasons
Heintz and Kaufman endorses
TUBE STANDARDIZATION

STANDARDIZATION IS A WARTIME NECESSITY

Colonel C. C. Irwin, commanding officer of the Signal Corps Standards Agency, recently stated that a majority of Signal Corps contractors are heartily cooperating with the standardization program sponsored by his agency to the end that approved component parts and materials are used wherever possible in equipment supplied to the Signal Corps. "However, there are some," Colonel Irwin said, "fortunately only a few, who view this program as an attempt to put an unsound theory into practice. Such is, of course, not the case. Standardization is vitally necessary, not only to relieve bottlenecks in production and distribution; to facilitate maintenance by providing interchangeability of parts; but more important, to reduce equipment failures in the field.

"There is no theory in a Gold Star. "If the reasons behind the laconic phrases 'killed in action,' 'missing,' and 'plane failed to return' could be explained, it is quite probable that equipment failures would bulk large among the reasons. "It is not expected that the use of approved standard component parts will eliminate equipment failures, but it most certainly will reduce them."

EQUALLY ADVANTAGEOUS IN THE POSTWAR PERIOD

Joint Army and Navy Specifications ("Jan-1A specs") have already established standards of electrical similarity and physical dimensions for vacuum tubes. Heintz and Kaufman will voluntarily continue to apply these engineering standards to postwar Gammatrons as the benefits are so obvious that we believe the designers of communications equipment will insist upon their continuation:

1. Standardization of specifications will facilitate equipment design and production, since it assures

the designer that there will be no physical or electrical changes made in the tube type he has selected. Often such changes have necessitated extensive re-design of equipment.

2. It will assure performance where performance is vital... in air transport and marine communications, in navigation and direction finding.

3. By establishing rigid electrical and physical requirements and tests, tube failures will be materially reduced. Such failures often reflect on the manufacturer of equipment, and must be guarded against just as carefully in peacetime as in war.

STANDARDIZATION DOES NOT LIMIT NEW DESIGN

Standardization of the specifications for current Gammatron tube types will not restrict the development of additional types to meet future needs. (Next month we will list here the Gammatron tubes which will be available indefinitely under our voluntary standardization program.)

Have you written for data on the HK-257B (JAN. 4E27)?



HEINTZ AND KAUFMAN LTD.
 SOUTH SAN FRANCISCO • CALIFORNIA

KEEP BUYING  WAR BONDS

Gammatron Tubes

Here is advanced Relay Engineering!

TYPE BN

The Allied 6-pole, double-throw BN type embodies many new improvements for heavy duty 6-pole switching . . . permits individual adjustment of contacts. Molded Bakelite is used throughout the relay. Contacts are rated at 10 Amperes. As in all Allied relays, the BN is designed for compactness and minimum weight. May be furnished normally open or normally closed or double-throw. Available in AC or DC. Weight: 11 oz. Write for complete operating characteristics, etc.

Height: 2 9/16" Length: 3" Width: 1 23/32"



TYPE CN

The CN relay is the result of advanced engineering technique and succeeds Allied's successful AN type . . . a power relay expressly designed for breaking heavy current. Contact rating is 50 Amperes at 24 Volts DC with silver contacts; with alloy contacts the contact rating is 75 Amperes at 24 Volts DC. (The latter arrangement with the alloy contacts is known as the CNS type.) The contact arrangement is single pole, single throw, double break, normally open or normally closed. The new design incorporates molded Bakelite insulation, greater electrical clearance and over-all improved mechanical structure. Available in AC or DC. Complete data on request.

Height: 2 1/2" Length: 2 1/4" Width: 2"



The two relays described above are typical examples of the many new types of relays Allied is constantly designing for its customers' widely diversified requirements.

Allied's engineering staff continually works to improve relay designs and to develop new magnetic control devices for present and future manufacturers whose products require electrical control. The highly practical accumulated knowledge of these men is at your command. Send us your control problems!



ALLIED CONTROL COMPANY, INC.

2 EAST END AVENUE (at 79th Street) NEW YORK 21, N. Y.

FACTORIES: NEW YORK CITY • PLAINVILLE, CONN.

ALLIED CONTROL CO. OF CALIFORNIA, INC. • 1633 SOUTH HOPE STREET • LOS ANGELES 15, CALIFORNIA
ALLIED CONTROL COMPANY, INC. • 4321 NORTH KNOX AVENUE • CHICAGO 41, ILLINOIS

HOW QUICK IS A WINK ?

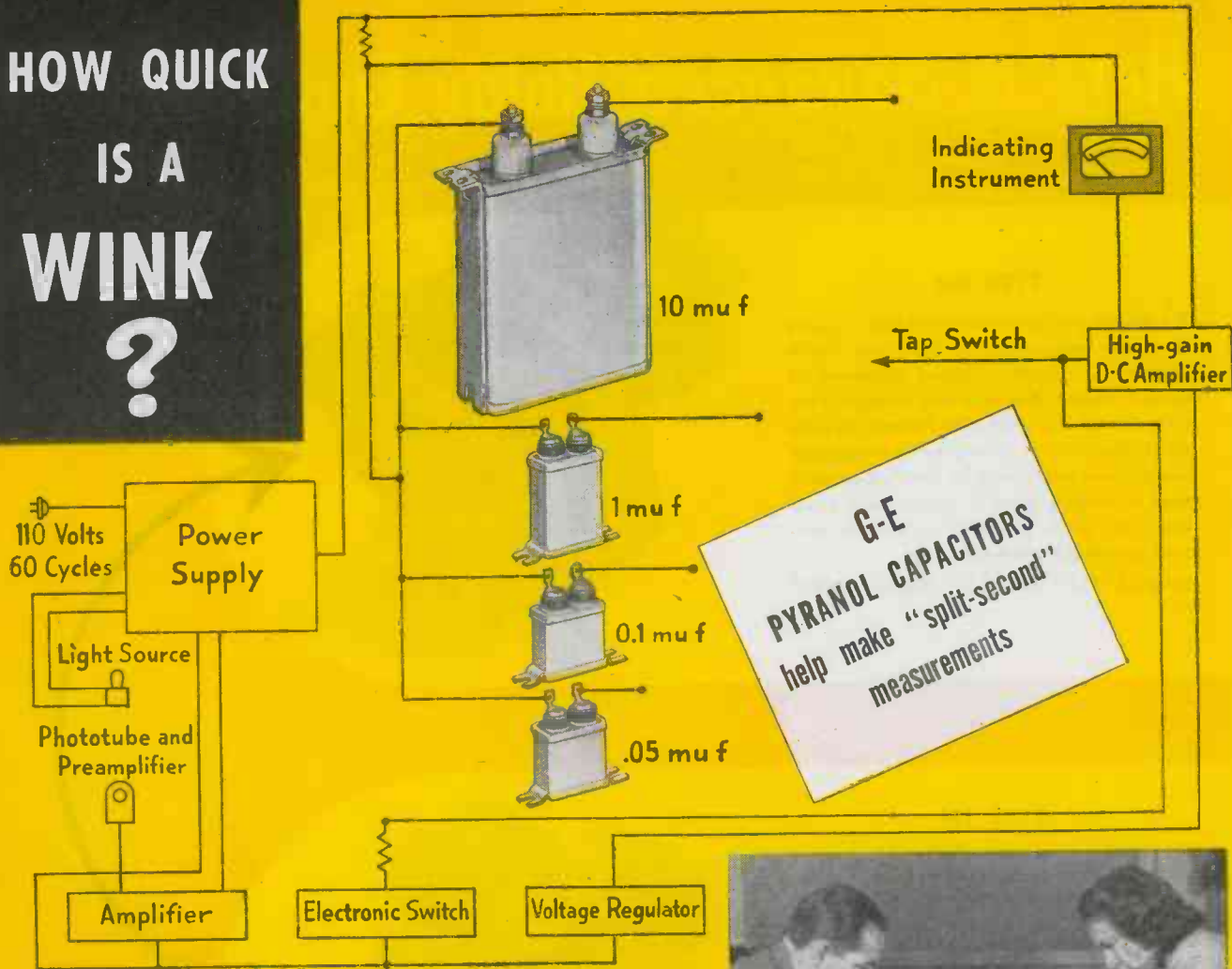

**G-E
PYRANOL CAPACITORS**
help make "split-second"
measurements

Another new job for capacitors

WHILE we have not yet measured the quickness of a wink with the time-interval meter, we know that it will do more practical jobs like measuring the time required for a camera shutter to open, or the time that it remains open. This meter is also being used to synchronize flash-bulb contacts on camera shutters, test relay performance, and measure the velocity of moving bodies.

Here's how Pyranol* capacitors are used in its circuit: An external contact or a phototube, working through the amplifier, causes the electronic switch to close during the time period to be measured. While the electronic switch is closed, one of the Pyranol capacitors is charged at a constant rate through a precision resistor. Thus, the voltage developed across the

Pyranol capacitor is a direct measure of the required time interval.

Four Pyranol capacitors and several charging resistors are used to obtain eight full-scale ranges (0.001, 0.003, 0.01, 0.03, 0.1, 0.3, 1, and 3 seconds). A tap switch on the instrument panel is used to select the correct Pyranol capacitor and resistor for the desired scale range.

An inverse feed-back arrangement holds the charging rate constant while the Pyranol capacitor is charging, and also corrects for leakage in several elements. The feed-back principle also enables the use of a direct indicating instrument to measure the capacitor charge, without discharging the capacitor.

The way Pyranol capacitors are



This sensitive electronic instrument accurately measures time intervals as short as 1/10,000 second. It is being used here to measure the time the man takes to react and turn off the lamp after it has been turned on by the girl. (Reaction time on this test: 175-200 milliseconds.)

used in this circuit may suggest a better way to do some job in one of your circuits. Remember that the high capacitance per cubic inch of Pyranol capacitors, their compact, space-saving shapes, and long life make them ideal for a wide variety of built-in applications.

Booklets on our various lines—h-f paper dielectric, h-f parallel plate, Lectrofilm, as well as Pyranol units—are yours for the asking. General Electric, Schenectady 5, N. Y.

*Trade-mark Reg. U.S. Pat. Off.

GENERAL ELECTRIC

407-85-5700



WE'RE IN THERE PUNCHING

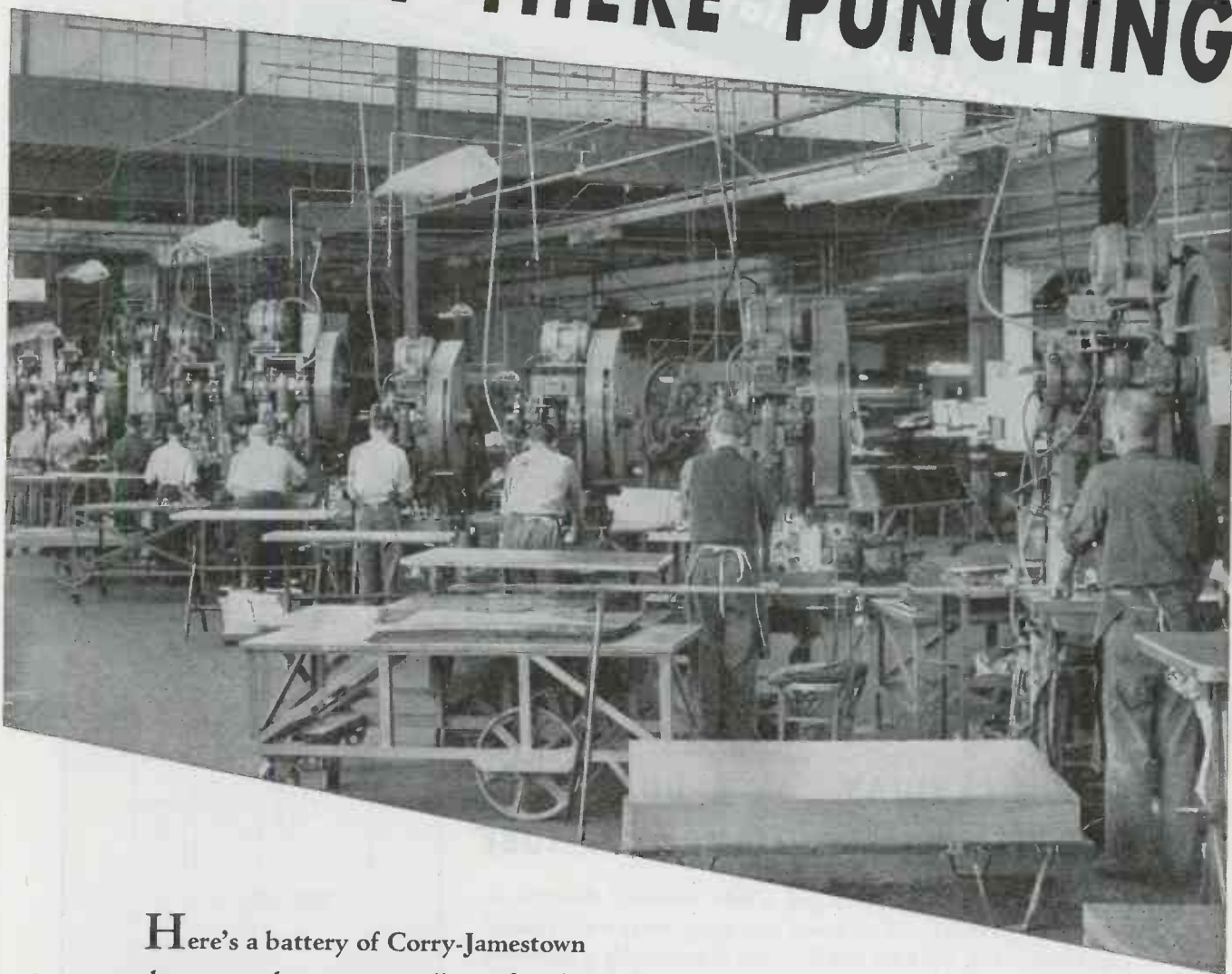

Here's a battery of Corry-Jamestown punch presses that pretty well typifies the spirit of our whole organization—all in there punching away to get out materials of war—in our case, for the electronics industry.

All during the war, we've been supplying leaders in electronics manufacturing with chassis mounting assemblies, panels, transformer housings and cabinets. We've worked in steel, stainless steel and aluminum to rigid Army and Navy specifications.

The kind words our customers have paid our abilities have encouraged us to or-

ganize a permanent, postwar Electronics Division.

We'd appreciate an opportunity to quote on your specifications for either war or postwar work.

CORRY-JAMESTOWN
MANUFACTURING CORPORATION
CORRY, PENNA.

Steel Age

1/5 The Size of a
Standard Miniature!



RAYTHEON CK510AX . . . A DUAL SPACE CHARGE TETRODE AUDIO AMPLIFIER TUBE

Raytheon engineers recently developed a tube radically different in design and performance—yet so *small* that many users were amazed by its capabilities. It is the CK510AX, which is essentially a very low-drain filament type dual tetrode intended for cascade operation as a high-gain audio amplifier.

A unique feature is a space charge grid around the filament—which produces two virtual cathodes, one for each section. Thus from a single filament two individual tetrodes are obtained, between which there is a minimum of interaction.

This tiny tube occupies only one-fifth the physical volume of a standard miniature type, yet voltage gains of approximately 250 may be obtained in the simple circuit illustrated here. The CK510AX is further proof of Raytheon's ability to develop new and better tubes . . . tubes that will be in ever-increasing demand in the new era of electronics to come.

PLEASE DIRECT INQUIRIES TO OUR COMMERCIAL ENGINEERING DEPARTMENT, NEWTON, MASS.

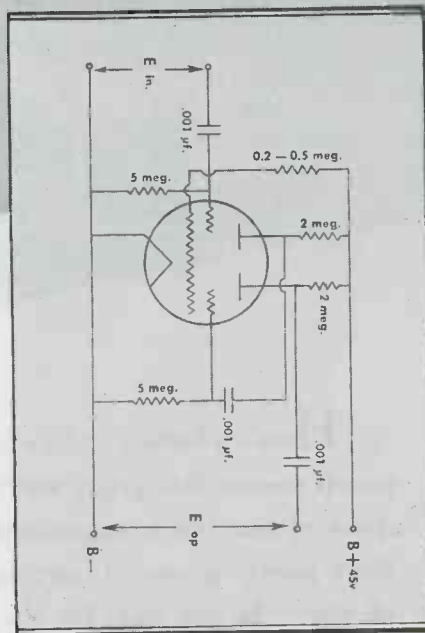

Specifications of CK510AX

Physical:

Bulb	T2X3 Flat Glass
Maximum Length	1.25 inches
Maximum Width	.385 inches
Maximum Thickness	.285 inches
Minimum Lead Length	1.25 inches

Electrical:

Filament Voltage	0.625 volts
Filament Current	50 ma
Maximum Plate Voltage	45 volts
Control Grid Voltage*	0
Space Charge Grid Current	75 to 150 ma
Approximate Voltage Gain	250

*Grids Returned to Negative Filament through 5 megohms.

RAYTHEON

RADIO RECEIVING TUBE DIVISION

Newton, Mass. • Los Angeles • New York • Chicago • Atlanta



All Four Divisions Have Been Awarded the Army-Navy "E" with Stars

DEVOTED TO RESEARCH AND THE MANUFACTURE OF TUBES AND EQUIPMENT FOR THE NEW ERA OF ELECTRONICS

ELECTRONIC INDUSTRIES • April, 1945

CO-EXPERIMENTERS IN ELECTRONIC RESEARCH



As the science of electronics reaches out to new horizons, the contributions of research specialists in insulation become increasingly important. It is our job to research materials and develop bodies for insulators with the special characteristics and performance that enable the designer's theory to become practice. In cooperation with manufacturers of electronic, radio and electrical equipment, we have developed formulas and designs for ALSIMAG Insulators which are vital parts of communications and controls of planes, warships, tanks, guns and other machines of war. Constant research, experimentation and commercial development keep pace with the insulating requirements of today's products and provide the foundation for tomorrow's designs. Whatever you are planning in the electrical and electronic field we believe our experience and specialized knowledge of insulators can be helpful. Let's work together.

AMERICAN LAVA CORPORATION
Chattanooga 5, Tennessee

43RD YEAR OF CERAMIC LEADERSHIP

ALSiMAG

TRADE MARK REG. U. S. PAT. OFFICE

CERAMIC INSULATORS

FOR USE IN:
Electronic Devices
Electrical Circuits and
Appliances
Gas and Oil Heating



LCO has been awarded for the fifth time the Army-Navy "E" Award for continued excellence in quantity and quality of essential war production.

ANOTHER QUALITY PRODUCT

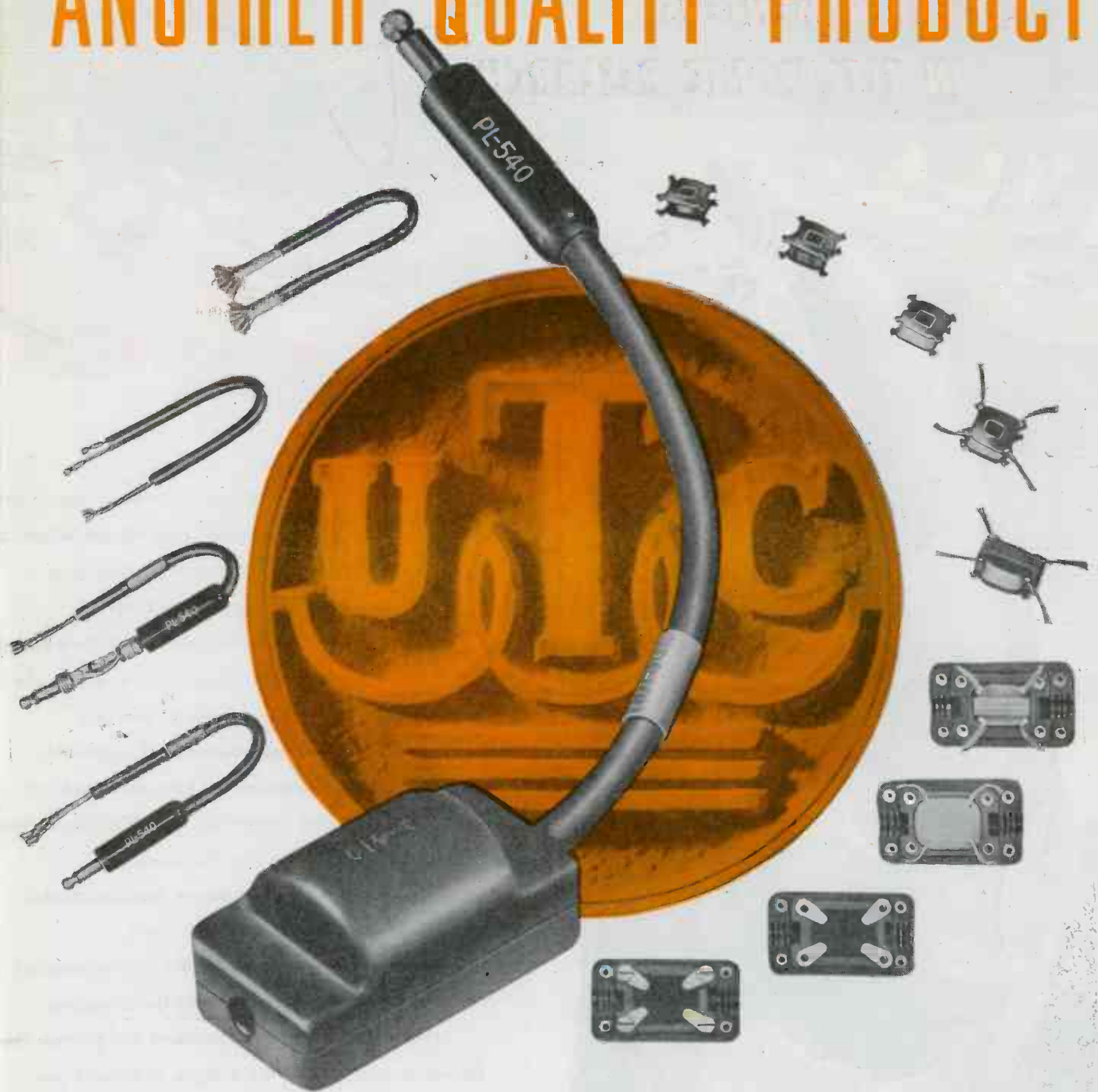

CD-604, CD-605 TRANSFORMER-CORD SETS

UTC production facilities for these Signal Corps headset adapters permit acceptance of additional quantity orders for quick delivery. Also available in hermetic construction.



May we cooperate with you on design savings for your applications...war or postwar?

United Transformer Corp.

150 VARICK STREET

NEW YORK 13, N. Y.

EXPORT DIVISION: 13 EAST 40TH STREET, NEW YORK 16, N. Y.

CABLES: "ARLAB"

ELECTRONIC INDUSTRIES

Including INDUSTRIAL ELECTRONICS

O. H. CALDWELL, EDITOR ★ M. CLEMENTS, PUBLISHER ★ 480 LEXINGTON AVE., NEW YORK (17), N. Y.

The Prospective Radio Allocations

The Federal Communications Commission will shortly announce its final radio allocations covering television, FM, civilian walkie-talkies, facsimile, aviation, industrial and medical diathermy, and many other services.

Careful engineering consideration has been devoted to the intricate and difficult problems involved. And certainly full opportunity has been given to all interests to be heard.

Whatever arrangements are finally announced, it is now clear that the allotments eventually to be fixed can be counted upon to provide the setting for the greatest public service,—the most tremendous commercial development,—that radio men have ever witnessed. Foundations will indeed have been laid in the electromagnetic spectrum for the Golden Age of Radio!

Television and FM Go Ahead

Television will receive the "green light" for immediate service to waiting millions, (meanwhile creating thousands of new jobs). Television will also be given the opportunity to develop in the higher frequencies, and there show what it can do in the direction of higher definition, color, and other improvements.

Frequency modulation will expand into a universal local service reaching millions of homes,—a service free of interference and rich in tone fidelity. With additional channels and stations becoming available under the new FCC assignments, FM's self-evident merits will create a huge volume of new sales for the radio industry.

AM's Billion-Dollar Backlog

Amplitude-modulation broadcasting will long continue to furnish the bulk of listening service, with a replacement backlog already approaching billion-dollar magnitude.

Facsimile lately has been showing new vitality in

commercial applications, so that the "home radio printing press" may yet become a reality.

Civilian "walkie-talkies" offer a new manufacturing and merchandising opportunity. Here, in fact, may lurk one of the "dark horses" of future radio-electronic development.

A Platform for Future Expansion

Even admitting all the criticisms,—certainly in its main outlines, the new FCC platform for radio expansion is adequate. Undoubtedly it seems to be the best that human effort and engineering knowledge can presently achieve.

And it all adds up to a future of unparalleled opportunity for every radio man and radio engineer who plans to have a part in postwar radio. Every radio man will find that under the new allocations the way has been blazed for a radio future that will tax all efforts to supply a waiting public with its expanding radio needs!

Re-Survey Military Stocks on Hand

In the electronic field as well as in the general supply situation, it is time to survey the military stocks on hand, else we shall be confronted with a tremendous postwar surplus. Contrary to the expressed military sentiment aiming at "peak of production on V-day," we think that as the close of fighting becomes foreseeable, stocks on hand should be re-surveyed, and cut-backs ordered.

Insure the boys at the front getting everything they need, of course. But safeguard the postwar future against useless surpluses that have cost billions.

Stopping the Stops on the Stop-Orders!

The way the war was going, authorities were having difficulties in catching up with cancelling the previous cancellations of orders. But now it seems as if cancellation of the cancellation of those cancellations is industry's principal headache!

THE NAVY USES MILLIONS OF VACUUM TUBES IN ITS EQUIPMENT AFLOAT

A few of the various types of Navy vessels with the number of vacuum tubes used for communications and other purposes on each



DESIGNING FILTERS

By ARTHUR H. HALLORAN

Empirical formulas for determining characteristics of low-pass and high-pass units for various purposes

● Electric wave filters are designed to separate current at wanted frequencies from current at unwanted frequencies in a band containing both kinds. In an ideal filter the wanted frequencies are passed on to a specified load without being attenuated. The unwanted frequencies are so highly attenuated before reaching the load that they are practically eliminated therefrom. Both sets of currents are also shifted in phase, to a varying degree for the wanted frequencies and to a constant degree for the unwanted.

Filter types

Two general kinds of filters are available, low-pass and high-pass. The low-pass type is designed to pass a band of frequencies which are less than some specified cut-off frequency (f_c), and to attenuate all frequencies higher than f_c . The high-pass type is designed to pass a band of frequencies which are higher than some specified frequency (f_c), and to attenuate all frequencies lower than f_c . The input impedance of the filter is made equal to the output impedance which is designed to match the load. Low-pass and high-pass filter sections are combined to form band-pass and band-stop filters. Consideration is herein confined primarily to the design and per-

formance of low-pass and high-pass sections.

The general principle of design depends upon the facts that an inductance (L) tends to pass low frequencies and to stop high frequencies, whereas a capacitance (C) tends to pass high frequencies and to stop low frequencies. Consequently, a low-pass filter is assembled with inductive elements in series, to pass low frequencies and stop high frequencies, and capacitive elements in shunt, to bypass high frequencies and stop low frequencies. Conversely, a high-pass filter is an assembly of series capacitive elements and shunt inductive elements. For practical design purposes the resistance of the inductance coils and the conductance of the capacitors are neglected.

For either low-pass or high-pass the basic values of L and C are $L = 0.159 R/f_c$ henries.....(a)

$C = 159,000/Rf_c$ microfarads....(b) where R is the resistance of the load in ohms and f_c is the cut-off frequency in cycles per second. When f_c is expressed in megacycles per second, eq(a) gives L in microhenries and eq(b) gives C in mmfd.

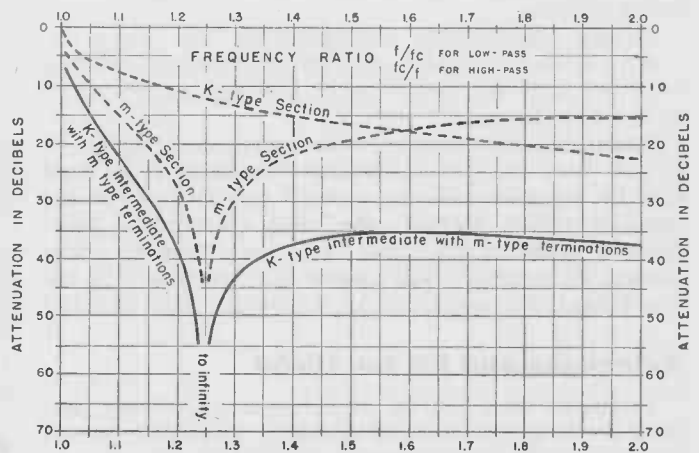

Fig. 1—Characteristics of filter performance

Another design factor to be considered is the attenuation that may be desired for any specified frequency (f).

The attenuation is zero at cut-off (f_c) and increases as the frequency becomes greater than f_c for low-pass, or less than f_c for high-pass. The solid-line curve in Fig. 1 shows the relationship between the fre-

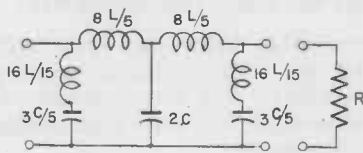

Fig. 2a

Fig. 2b

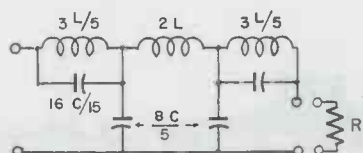
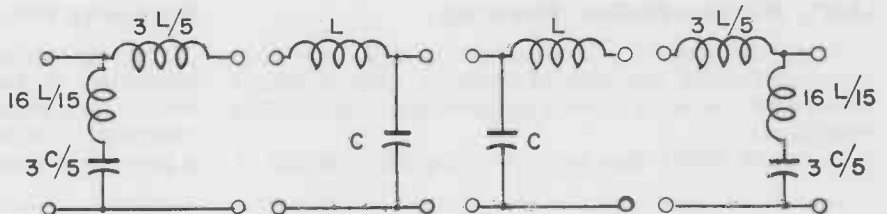
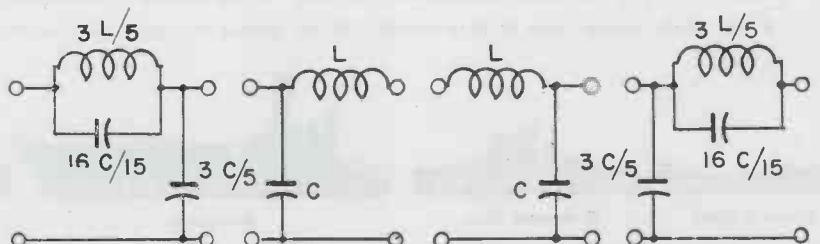

Fig. 3a

Fig. 3b



FOR SPECIFIC JOBS

quency ratio (along the horizontal scale) and the attenuation in decibels (along the vertical scale) for any of the composite filters in Figs. 2 to 5. (The broken-line curves are to be discussed later.)

The solid-line curve consists of two branches, one to the left of the vertical line from the 1.25 ratio and one to the right of the line. That on the left drops rather abruptly from zero decibels for a frequency ratio of unity to an infinite negative value for a frequency ratio of 1.25. That on the right changes more gradually from an infinite value at 1.25 to a value of 36 db for a ratio of about 1.6 and then the attenuation very gradually becomes greater for higher ratios.

Attenuation factors

This curve may be used to select a value for f_c to provide a prescribed attenuation for any specified frequency (f). For example, suppose that a low-pass filter is required to attenuate 60 cps potentials by 30 db. The branch to the left shows that 30 db corresponds to a ratio of 1.15. Consequently,

$$f/f_c = 60/f_c = 1.15, \text{ whence } f_c = 52 \text{ cps.}$$

When this value for f_c is substituted in eq (a) and (b), together with a specified value for R , they give values for L and C to be used in Figs. 2 or 3. These filters will then provide an attenuation of 30 db for 60 cps and a minimum of 36 db for all higher frequencies, as shown by the branch at the right.

For a high-pass filter to attenuate by 30 db, or more, all frequencies of 60 cps or less, the equation is

$$f_c/f = 60/60 = 1.15, \text{ whence } f_c = 69 \text{ cps.}$$

When this value for f_c is substi-

tuted in eq (a) and (b), together with a specified value for R , they give values for L and C to be used in Figs. 4 or 5.

Figs. 2(a) and 3(a) show two types of composite low-pass filter sections that provide the attenuation characteristic shown by the solid-line curve in Fig. 1. The cir-

merical values for L and C from eq (a) and (b) and substituting the fractional values given in Figs. 2(a) or 3(a).

Examples:

1(a). Design a low-pass filter with shunt input and output to

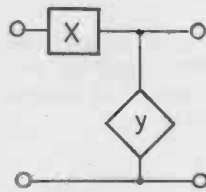

Fig. 6a

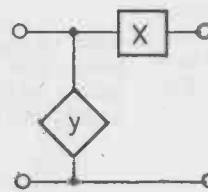

Fig. 6b

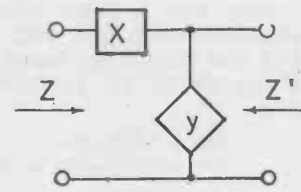

Fig. 6c

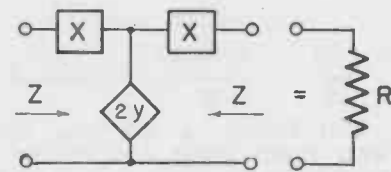
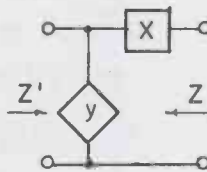
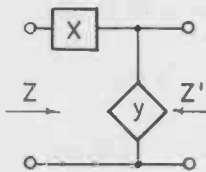

Fig. 7

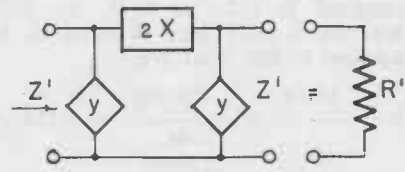
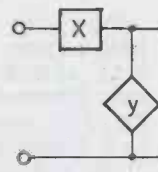
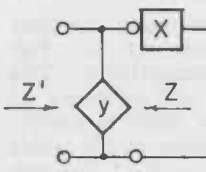

Fig. 8

cuit in Fig. 2(a) has a shunt input and output, whereas that in Fig. 3(a) has a series input and output. Since the attenuation characteristic is the same for both types, choice is solely a matter of convenience in construction. After selecting f_c , the design procedure consists simply in figuring the nu-

provide an attenuation of 15 db for 1000 cps with a load of 700 ohms.

From Fig. 1, 15 db is seen to correspond to $f/f_c = 1000/f_c = 1.05$, whence $f_c = 950$ cps.

$$L = \frac{.159 R}{f_c} = \frac{.159 \times 700}{950} = 0.117 \text{ h}$$

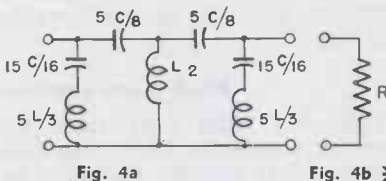

Fig. 4a

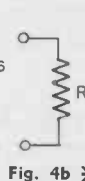

Fig. 4b

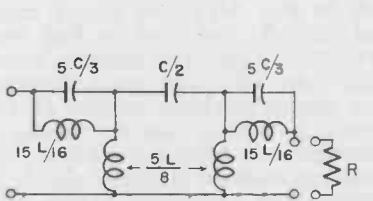
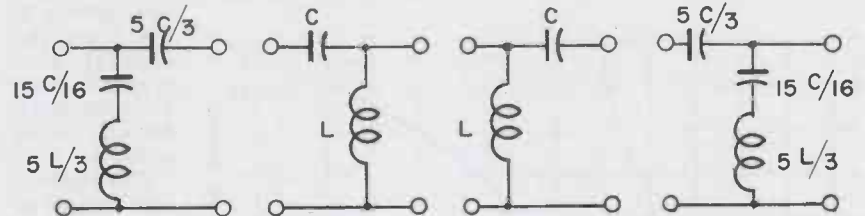

Fig. 5a

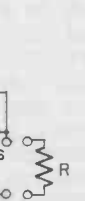
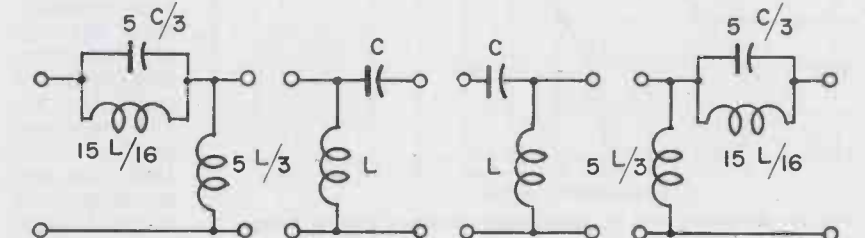

Fig. 5b



$$C = \frac{159000}{f_c R} = \frac{159000}{950 \times 700} = 0.239 \mu f$$

$$\frac{8L}{5} = \frac{8(0.117)}{5} = 0.187 h$$

$$\frac{3C}{5} = \frac{3(0.239)}{5} = 0.143 \mu f$$

$$\frac{16L}{15} = \frac{16(0.117)}{15} = 0.125 h$$

$$2C = 2(0.239) = 0.478 \mu f$$

These values applied to Fig. 2(a) give required structure.

1(b). For a filter, with similar characteristics but with series input and output get value for L and C, as above, for insertion in Fig. 3(a).

$$\frac{3L}{5} = \frac{3(0.117)}{5} = 0.07 h$$

$$\frac{16C}{15} = \frac{16(0.239)}{15} = 0.275 \mu f$$

$$2L = 2(0.117) = 0.234 h$$

$$\frac{8C}{5} = \frac{8(0.239)}{5} = 0.382 \mu f$$

2(a). Design a low-pass filter with shunt input and output to provide an attenuation of 15 db for 75 mc with a load of 50 ohms.

From Fig. 1, 15 db is seen to correspond to $f/f_c = 75/f_c = 1.05$, whence $f_c = 71$ Mc. Values to be applied to Fig. 2(a) are,

$$L = \frac{.159 R}{f_c} = \frac{.159(50)}{71} = 0.112 \mu h$$

$$C = \frac{159000}{f_c R} = \frac{159000}{71(50)} = 44.77 \mu \mu f$$

$$\frac{8L}{5} = \frac{8(0.112)}{5} = 0.179 \mu h$$

$$\frac{3C}{5} = \frac{3(44.77)}{5} = 26.86 \mu \mu f$$

$$\frac{16L}{15} = \frac{16(0.112)}{15} = 0.119 \mu h$$

$$2C = 2(44.77) = 89.54 \mu \mu f$$

2(b) Similarly, a low-pass filter

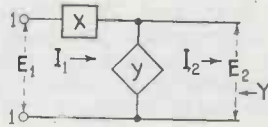
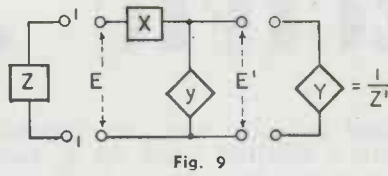

with series input and output to meet the same requirements, requires values for L and C as above, to be used in Fig. 3(a).

$$\frac{3L}{5} = \frac{3(0.112)}{5} = 0.0672 \mu h$$

$$\frac{16C}{15} = \frac{16(44.77)}{15} = 47.75 \mu \mu f$$

$$2L = 2(0.112) = 0.224 \mu h$$

$$\frac{8C}{5} = \frac{8(44.77)}{5} = 47.75 \mu \mu f$$

K- and M-Type components

Figs. 2(b) and 3(b) show the four half-section components of Fig. 2(a) and 3(a), respectively. The two intermediate half-sections of Fig. 2(b) constitute what is known as a T-section (K-type) with series input and output; each of the end half sections are of the m-type with shunt input or output. The difference between K- and m-types is discussed in sequel. The two intermediate half-sections of Fig. 3(b) constitute a π -section (K-type) with shunt input and output; each of the end half-sections are of the m-type with series input or output. Anticipating the explanation of the difference between the K- and m-types, it may here be stated that

the curves in Fig. 1 and the circuit diagrams in Figs. 2-5 have been drawn for $m = 0.6$.

The broken-line curves in Fig. 1 show the relationship between attenuation and frequency ratio for K- and m-type sections. Note that the attenuation due to the K-type section in-

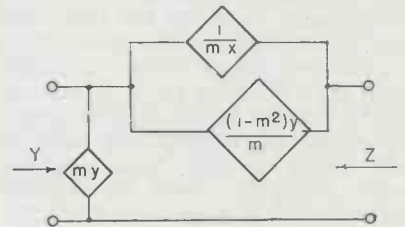
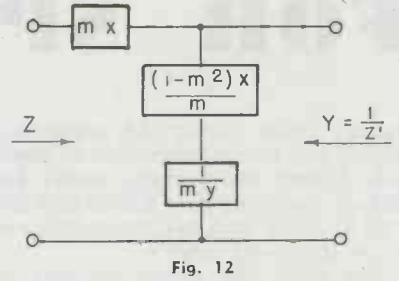

creases gradually as the frequency ratio increases, whereas that due to an m-type section increases rapidly to an infinite value for a ratio of 1.25 and then decreases gradually as the ratio continues to increase. The attenuation due to a combination of a K-type section with m-type half-section terminations is equal to the sum of the two, as shown by the solid-line curve in Fig. 1.

A single K-type section without m-type terminations may be used to provide moderate attenuation for frequencies far removed from cut-off, or an m-type section consisting of two half sections may be used to provide high attenuation for one frequency close to cut-off and less attenuation for remote frequencies. A combination of the two, however, provides the most satisfactory form of attenuation for practical application. When more than 36 db is desired, the simplest plan is to connect two or more composite sections in series, their attenuations being additive. Half-section K- and m-types, providing half the attenuation shown by the curves, are also used as coupling circuits or half-section filters.

High-pass sections

Figs. 4(a) and 5(a) show two types of composite high-pass filter sections that provide the attenuation characteristic shown by the solid-line curve in Fig. 1. The circuit in Fig. 4(a) has shunt input and output, and that in Fig. 5(a) has series input and output. Since both types have the same attenuation characteristic, choice of the type to be used is solely a matter of convenience. After selecting f_c , the design procedure consists simply in figuring the numerical values of L and C from eq (a) and (b) and

(Continued on page 134)

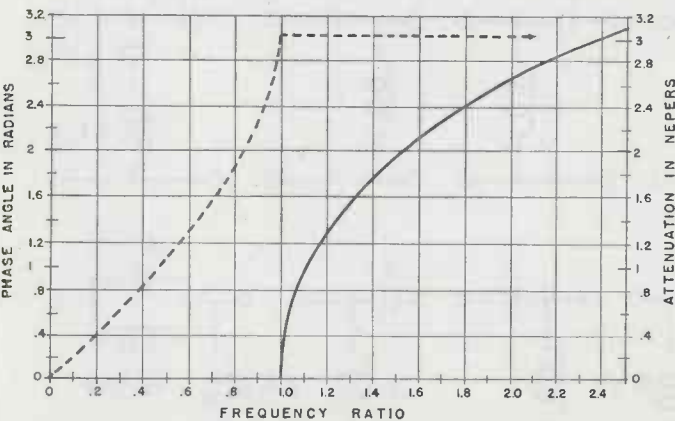

Fig. 11—Frequency ratio vs. phase angle and attenuation for K-type half section filter

THE VIBRATRON

A versatile displacement conversion unit that serves the audio frequency field as does the crystal in rf technic

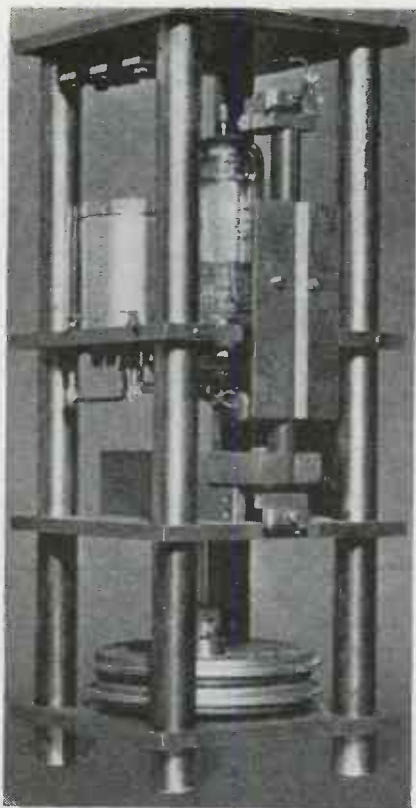

Fig. 1. Vibratron unit adapted to barometric pressure measurements

• Many of the outstanding developments in the field of measurements and control have resulted from a combination of simple, well known physical laws modernized with electronic accessories and painstaking engineering that becomes necessary when the accuracy range of any device is extended.

In the field of measurements, accuracy and stability are evaluated in terms of a few parts in a hundred for some quantities and a few parts in a hundred million for others, the latter notably those related to time, wavelength and frequency. Any developments which can utilize the latter quantities in the study of engineering factors associated with industrial tests, can be expected to have greater accuracy than otherwise if due care is exercised that nothing is done to nullify those conditions.

It is of interest to examine the details of the development of a new instrument, the Vibratron, that is accomplishing certain measurements with a new order of accuracy by making use of a method of converting other effects to a simple variation in frequency. This results in an instrument which is versatile enough to help in a great many industrial problems. The Vibratron is a recent development by Frank Rieber of the Rieber Research Laboratory in New York City. This instrument is peculiarly adapted to these problems for the following reasons:

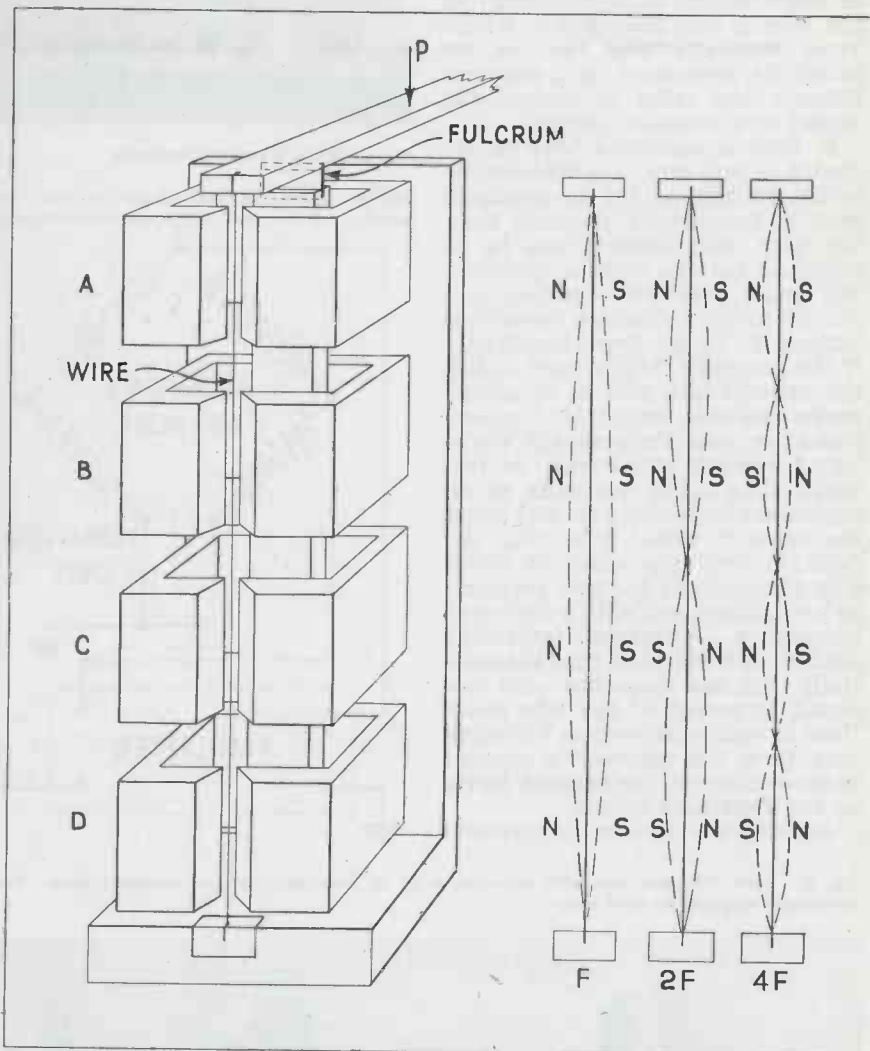

Fig. 2. Assembly principle used with one form of unit which employs four magnets to convert small displacements into shifts of output frequency. At right are the four types of vibration modes which can be produced by altering field polarities

First, it is capable of measuring a rather wide range of physical quantities, such as temperature, pressure, flow, potential displacement, etc.

Second, it converts those quantities to a variation in frequency which can be measured with great accuracy.

Third, the total scale of measurement may be divided into a large number of accurately reproducible units.

Fourth, the instrument retains its fundamental calibration to a high order of accuracy.

Fifth, measurements so made may be transmitted, for telemetering purposes, in extremely simple fashion since the frequencies used are

readily handled by simple amplifiers and by regular wire lines.

In essence the Vibratron is a continuously tunable high Q electro-mechanical resonator, employing a stretched wire in an electro-magnetic field as the actuating element. Before actually describing the unit a review of a few physical laws are in order. A wire stretched in free space, if rigidly supported so that a minimum of energy is lost by radiation through the supports, and if the amplitude of vibration is not large, has a natural period closely dependent on an inverse relation to its length, diameter, and the square root of its mass per unit length, and on a direct relation with the square root of the applied tension. Such a

wire has an electrical resistance of a definite value, to which a slight increment must be added in proportion to the tension on the wire. If the wire is in vibration, its resistance thus changes very slightly as a function of its motion—this latter change being small enough to be neglected in most instances. If the wire is now placed in a transverse magnetic field, it can no longer be considered as a pure resistance, but takes on instead the aspect of a resonant circuit.

If such a stretched wire is included in one arm of a Wheatstone bridge network, and if the magnetic field is temporarily removed from the wire, the network may be so balanced that no current whatever will pass from the exciting terminals to the output or measuring terminals. Under these conditions, if the magnetic field is now added, the network will still be in almost perfect balance except for frequencies at or near the resonant vibratory frequency of the wire. At resonance the latter performs as an equivalent impedance several times the value it would have with the field removed. For values on either side of resonance the wire performs as a reactance, and with a decreased impedance. A bridge containing such a wire will thus pass substantially only one frequency—the resonant frequency of the wire itself. Used in such a network, a Vibratron may form the controlling element in an oscillator if the network serves as the feed-back circuit.

Actually this dynamic component



Fig. 3. Audio frequency oscillator

Fig. 4. Below, feedback circuit by which vibrations of the wire are made self-sustaining

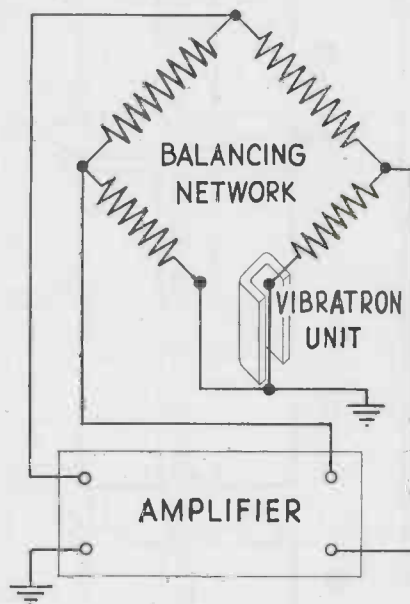
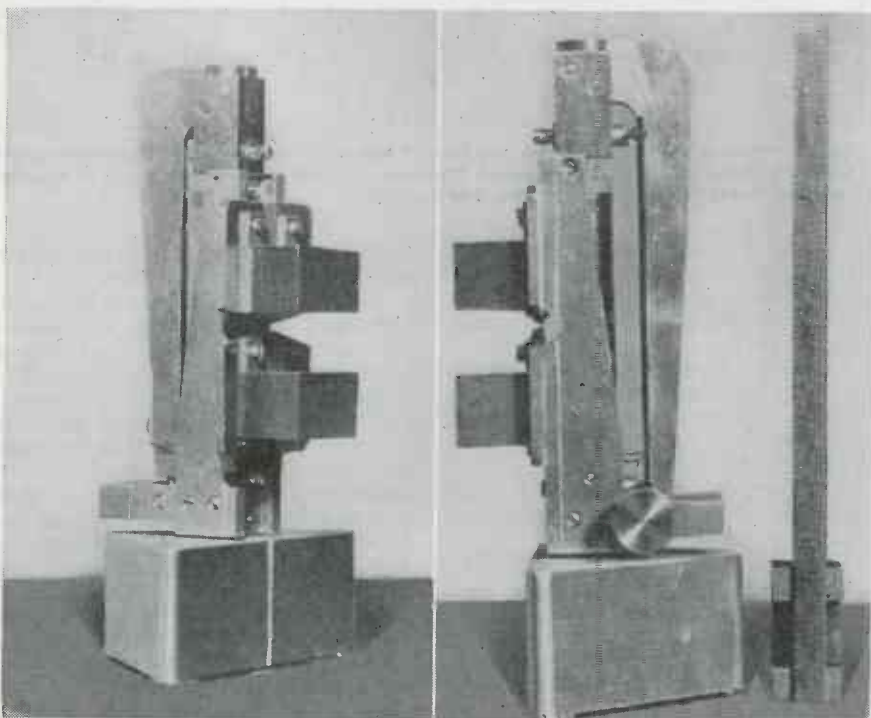

Fig. 5. Basic Vibratron unit with actuating lever of form applicable to industrial tests. Two permanent magnets are used here



of impedance can be analyzed from the concept of an alternating current generator, as a complex impedance having negative impedances during portions of the cycle, or in other ways, but in any case it is instrumental in introducing substantial changes from the balanced condition.

If an alternating current is applied to a wire placed in a magnetic field it will cause a transverse movement of the wire. Since this wire is held rigidly at the ends the relative movement along its length varies, being greatest, of course, at its center. It is quite possible to vary the magnetic field gradient along its length by shaping the pole pieces so that the deflection follows a true sinusoidal law, whenever a sine wave potential is applied to its terminals. As in any resonating circuit the extent of this movement is extremely small except when resonance occurs between the natural frequency of the wire and the applied potentials.

In the Vibratron all of the foregoing principles are used but the details of their application are worked out so that the frequency/tension relation is precisely standardized, so much so, that a repeatable check of a movement of one part in 10,000 can be obtained. As in Fig. 1 a small wire of some material such as tungsten is clamped in milled slots in the terminating blocks. These blocks are affixed to the ends of a pillar having a temperature coefficient sufficient to compensate for the change in frequency brought about by the thermal expansion of wire.

Bridge circuit feedback

This wire is placed in a highly concentrated transverse magnetic field from fixed or electromagnets, and is connected in one arm of a balancing network as in Fig. 3. The latter is balanced for a null with the magnetic field removed as explained above. After the field is applied, assume that the wire is then set into vibration by some random movement. The generated emf produced thereby varies at the natural resonance frequency of the wire, and alters the bridge balance, and a certain potential at this frequency is applied to the amplifier input. The amplified version of this frequency (with corrected phase) is then reapplied to the bridge. Since the bridge was initially balanced there is no feedback between the input and output circuits of the amplifier except that caused by the dynamic impedance characteristics of the wire, and this occurs at the resonant frequency. At this value oscillations occur at an amplitude depending on the characteristics of

(Continued on page 192)

WIRE FOOTAGE COUNTER

A high speed phototube counter for accurately measuring resistance wire used in precision resistor manufacturing

• The problem of winding precision resistors with 0.0015 in. wire and sizes up to 0.0035 in. is primarily one of accurate measurement of the length of wire wound into each groove of the form. Since a definite value of resistance is the desired product, the total length of wire is the important factor.

Briefly, the typical precision wire wound resistor is constructed by winding a suitable diameter nickel-chrome alloy wire (enamel insulated) onto a ceramic form. The ceramic form is a conventional bobbin but made with barriers to divide the winding space into two, four or other even number of sections. The required length of enameled wire is wound into an end section with the form rotating in one direction and then the wire is led through a notch in the ceramic barrier into the adjacent section. The form is then rotated in the opposite direction and a similar amount of wire is put on. This process is repeated until the resistor is completely wound.

The wire is guided onto the form by the operator using a suitable eyelet type pivoted guider. The windings are not perfectly layer-wound but the operator keeps them

as nearly level as possible by eye.

There are several disadvantages when using a turn counter. The tension on this small wire is light and is subject to considerable variation during the winding. This tension variation means that resistors wound with a fixed number of turns will not give the same resistance value. Some resistors will be wound "tight" others "loose" yet all have the same number of

turns. Consequently, the footage on the "tight" spool will be smaller.

A solution to these problems is available with a suitable footage counter. Because of the small wire sizes, the mechanical load of a recording counter must be extremely small. The inertia effect must also be small to prevent "skidding" of the counter when the rate of winding is suddenly changed. One type of counter which was designed for

Equipment set-up used to record length of resistance wire. Only wire load is rotation of wheel

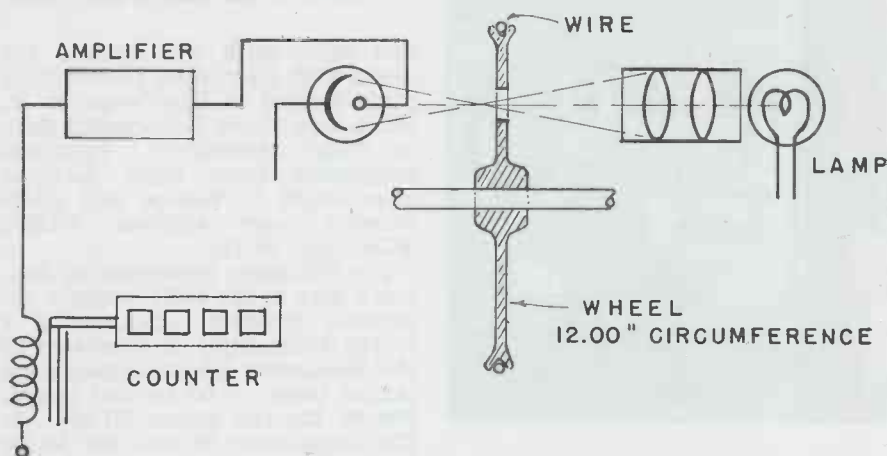

Measuring wheel shown below wire spool. Solenoid counter at lower right



this type of work at the Richardson-Allen Corp., N. Y., uses a photo electric scheme to minimize loading the wire.

Illustrated in the accompanying photo and drawing, the counter system employs an aluminum wheel of 12.00 in. circumference at the root of the groove. A $\frac{3}{4}$ in. diameter hole near the rim of the wheel allows the light from the lamp house to pass once each revolution and operate the photo-electric tube. The wire from the supply spool is passed completely around the measuring wheel and from there to the winding form through necessary guides.

Because of the small flywheel effect in the measuring wheel, slippage is at a minimum. The rim of the wheel is not coated as this was found to be unnecessary. A standard type photo-electric unit with built-in relay operates an electric solenoid counter which records each foot of wire being wound. Satisfactory counting is obtained at spindle speeds up to 3,500 rpm. This corresponds to approximately 150 feet per minute.

OWI-CBS 200 KW WEST



General view of the OWI-CBS international shortwave transmitter building, and a glimpse down the transmitter room each side of which provides space for a complete 200kw transmitter. Left, rear view of the modulator which delivers an output of 150 kw audio power

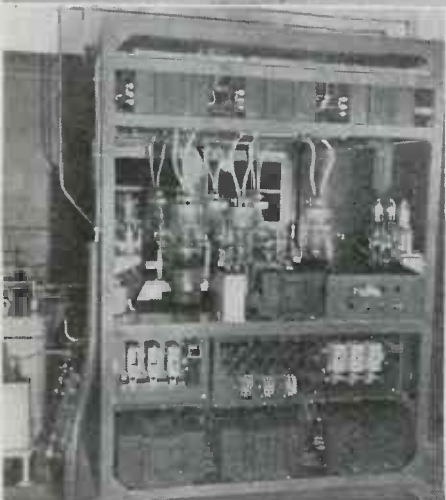

this early work was evolved the model CBS shortwave transmitting plant located at Brentwood, N. Y., which was placed in operation prior to Pearl Harbor.^{1,2,3} Programs emanating from these facilities were heard in Europe and Latin America over stations WCBX, WCRC and WCDA.

The Columbia Broadcasting System's part in the OWI wartime expansion included: (1) Placing a fourth transmitter in operation at the Brentwood plant, employing a carrier power of 50 kw and identified by the call letters WCBN. (2) The installation of two new 50 kw transmitters at the old WABC transmitter site located at Wayne, N. J., which have been in operation for over a year, using the call let-

ters WOOC and WOOW. (3) A new "super-power" international transmitting plant near Los Angeles, where two new 50 kw transmitters, KCBA and KCBF, were heard in the Far East for the first time on November 26, 1944; and where construction is now progressing toward the completion of a transmitter capable of emitting a carrier power of 200 kw.

Transmission path distances from the United States to required points in the Pacific theater are considerably greater than to major points in the European theater. A desire to provide superior reception in the Pacific area required utilization of greater transmitting power than heretofore had been used on high frequencies in this country, or

● Shortly after the United States entered World War II, our government, knowing the value of shortwave broadcasting, formulated plans to increase greatly international transmitting facilities within this country. The task of coordinating this program of expansion was given to the Office of War Information. The Columbia Broadcasting System, one of the pioneers of shortwave broadcasting in the United States, was among those requested to participate in the construction and operation of new international transmitting plants.

In the early thirties the CBS commenced experimentations in the field of international broadcasting. These experiments included the regular operation of shortwave transmitters of various powers, and the construction and trial of numerous types of antennas. From

The elaborate antenna switching system designed to facilitate the selection of any of the directional antennas and coupling them to the two 50 kw and the 200 kw transmitter



¹A. B. Chamberlain, "CBS International Broadcast Facilities," Proc. I.R.E., Vol. 30, No. 3, p. 118 (March, 1942).

²H. Romander, "New 50 KW CBS International Broadcasters," Electrical Communication, Vol. 21, No. 2, p. 112 (1943).

³H. A. Chinn, "Audio and Measuring Facilities for the CBS International Broadcast Station," Electrical Communication, Vol. 21, No. 3, p. 174 (1943).

COAST TRANSMITTERS

By **ROBERT N. DeHART,**

General Engineering Department
Columbia Broadcasting System

Technical details of Delano international plant for three carriers on the air simultaneously or independently

abroad. To design and construct a shortwave transmitter and associated equipment capable of emitting an output power approximately double that of any existing transmitter in this country, offered engineering problems that originally appeared insurmountable. The major obstacles were vacuum tubes designed for "super power" operation at the international frequencies. The Federal Telephone and Radio Co. produced tubes possessing the required specifications. Solutions were also found for design problems presented in the construction of antenna systems and other component parts capable of handling the greater powers.

As with any war project, it was important that this west coast plant be completed in a minimum of time. All efforts were directed toward this achievement while fol-

General layout of the 640-acre section showing transmitter building, transmission lines and rhombic antennas, and below azimuthal projection showing how various antennas are beamed

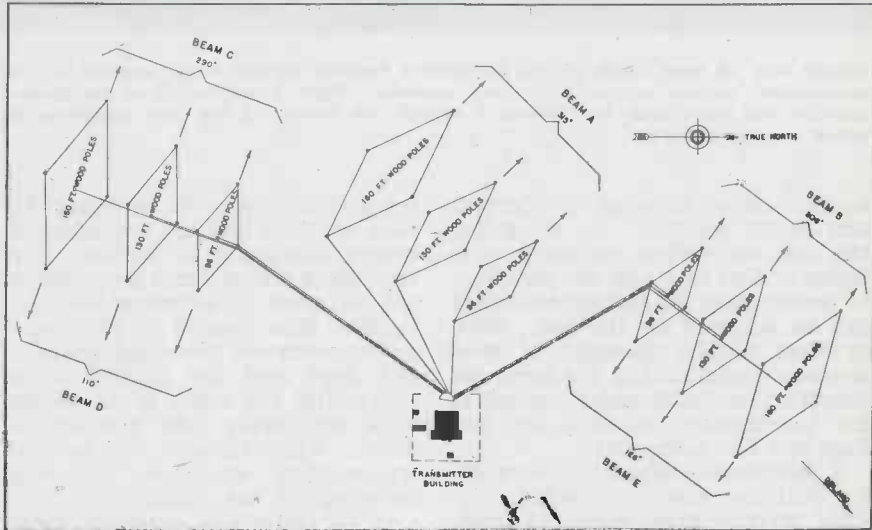

lowing good engineering practices throughout. Building construction was commenced in the spring of 1944. Approximately eight months later, KCBA and KCBF were placed in regular operation.

Approximately 640 acres of land, a plot one mile square, was needed for the transmitter building and directional antennas, and to provide room for expansion. A search was made of Southern California in an effort to find a site possessing necessary requirements and was found in the San Joaquin Valley near Delano, Cal.

A system of directional antennas of the Rhombic type was constructed. These are oriented at various great circle bearings so that transmissions can be beamed on sectors in the Far East or the Orient, as well as on Latin America.

The accompanying azimuthal projection, centered on Los Angeles, illustrates the following fortunate fact. Great circle bearings taken through the general region of the Far East or the Orient, if reversed, will bear on Latin America. That is, a system of directional antennas beamed on sectors of the Far East, can be made to reverse their direction of transmission by 180 deg. and they then may be used for

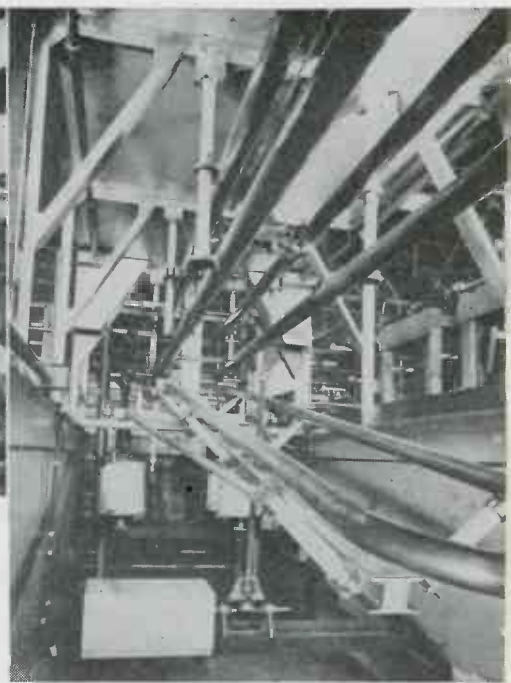
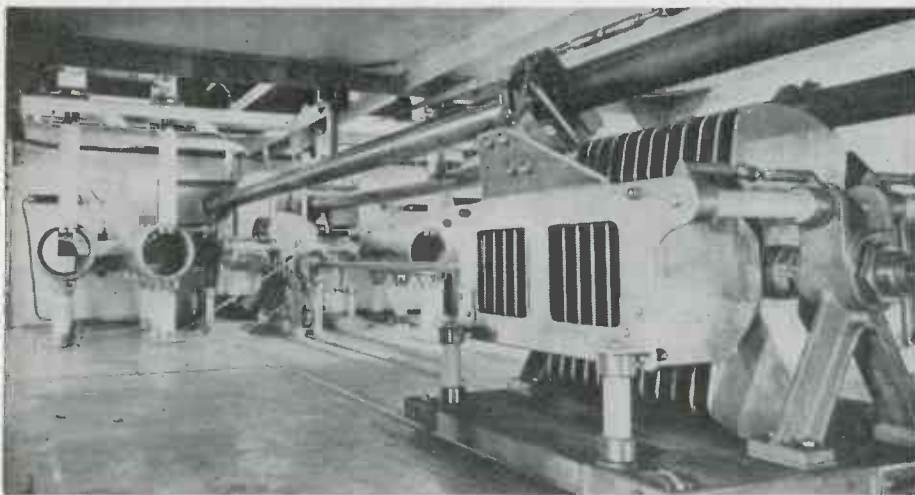

General view of input circuit of 200 kw inverted amplifier showing linear resonant line and motor-driven carriage carrying the tuning condenser. Right, output circuit of the inverted amplifier with three lines, two forming a parallel tank circuit and the third comprising the output coupling circuit

transmissions directed to Central and South America. In designing the antenna system advantage was taken of this fact and the direction of transmission of certain antennas can be reversed by 180 deg. This, in effect, doubles the utility of these antennas, eliminating the need for constructing additional antennas for transmission to both the Far East and Latin America.

A reinforced concrete transmitter building was constructed. Its total interior area serves to illustrate the hugeness of the various component parts which form a complete 200 kw transmitter. The usual building for a 50 kw transmitter has an interior area of approximately 5,000 sq. ft. The total interior area of the Delano transmitter building is approximately 16,000 sq. ft. The building consists of three basic sections: The main transmitter room and associated transformer vaults, the water cooling fan and pump room, and a wing containing the administrative office, workshops, kitchen and bedroom. This latter wing provides adequate facilities for the repair and construction work necessary for the proper maintenance and operation of the plant. These include a machine shop, general workshop and a laboratory which will be used for test, repair and construction of radio and audio units.

The transmitter room is made up of two identical sides, each side providing space for installing the various units which comprise a complete 200 kw transmitter. Transmitter cubicles, placed along the opposite sides of this room, occupy a total of 124 linear feet of panel space. These cubicles are so arranged that complete accessibility to the interior of the numerous

transmitter units is provided for ease of maintenance, thereby insuring continuity of service. The associated transformer components are mounted in adjacent fireproof vaults. Also, located in the transmitter room are the operator's control desk and the cabinet racks containing the audio-input amplifiers, measuring and test equipment. Approximately 61 tons of transmitting equipment has been installed in the building.

In an effort to provide an effective electrical ground for use within the building, a grid constructed

of copper bus was located beneath the building and tabs for equipment ground connections brought up through the concrete floors. This ground system grid is bonded to the steel reinforcing bars and girders of the building. In addition, buried copper radials are extended beyond the building for a distance of 50 ft.

The block diagram shows the general circuit arrangement of the basic transmitter units. Equipment has been designed and arranged so

Block diagram of basic circuit arrangement of the transmitter units providing for three carriers on the air simultaneously or independently. Right, beam reversing switch system

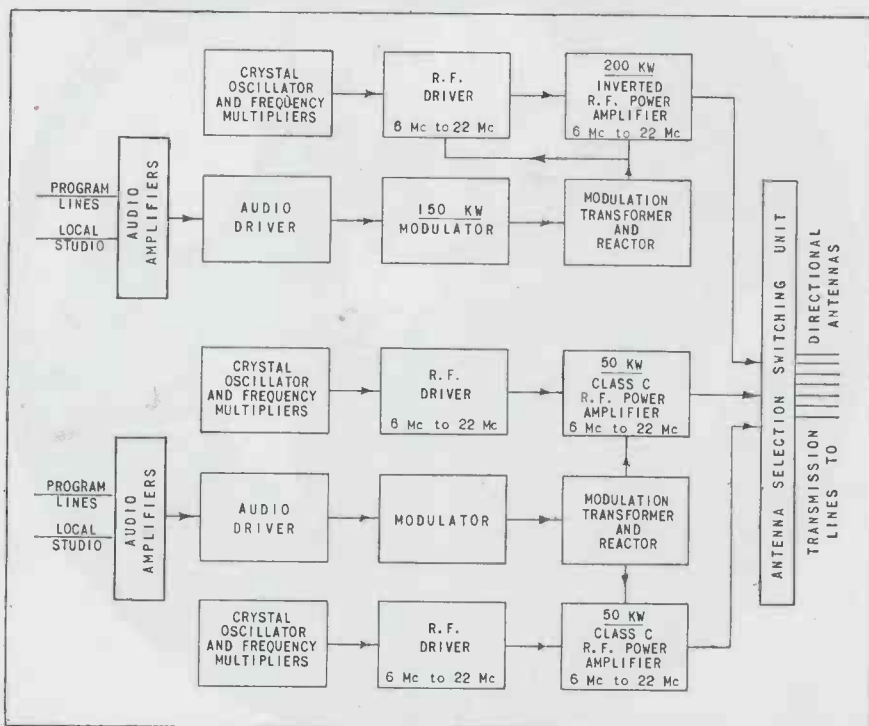

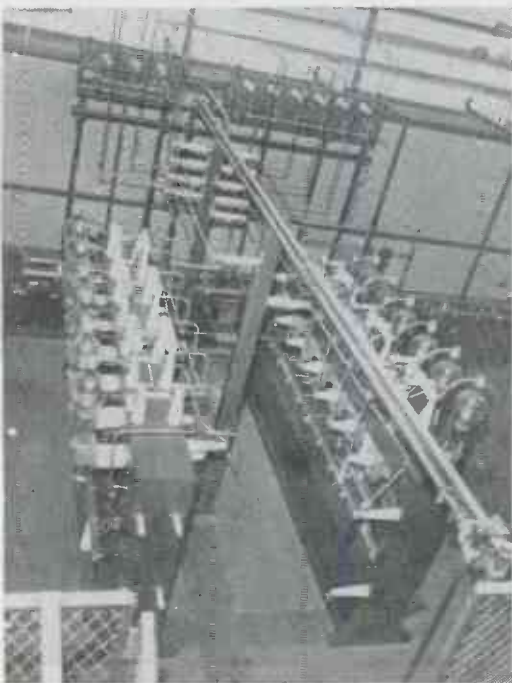

as to provide three rf carriers on the air simultaneously or independently at any given time. This includes the two 50 kw rf sections modulated from a common unit and the complete 200 kw transmitter which is being installed.

The dual 50 kw transmitter is composed of units obtained from two manufacturers (RCA and Federal) and is an excellent example of wartime cooperation that results in transmitters on the air in a minimum of time. With the exception of the two 50 kw rf channels, which are manufactured by RCA, all of the transmitting equipment

Manually operated switch to change the beam direction of an antenna

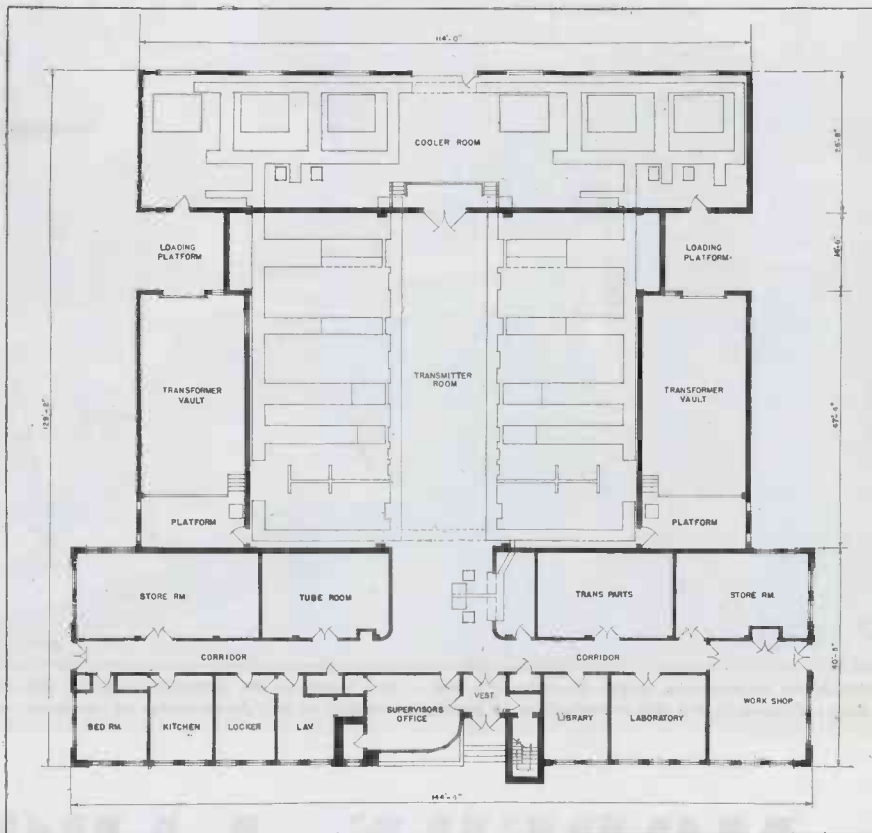
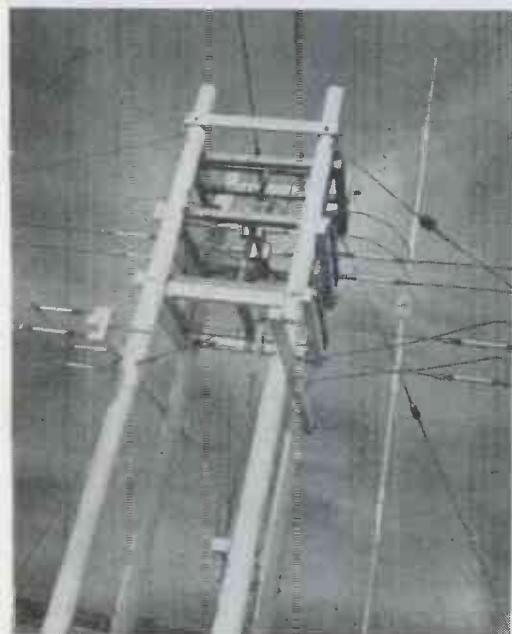

Left is the dc rectifier unit which serves as a source of plate power for both the rf power amplifier and the modulator of the 200 kw transmitter. Floor plan of complete station

installed at Delano was designed and constructed by Federal. Both the RCA power amplifiers are modulated from a common source, its design and construction being identical with that of a second existing Federal modulator which will be used to modulate the 200 kw carrier.

The third transmitter to be placed in operation at Delano will be capable of an output of 200 kw fully modulated 100 per cent and can be operated at any of the international frequencies. A crystal oscillator serves as an initial source of radio frequency energy. The crystal oscillator output is fed into a series of doubler and buffer stages, which in turn feed the rf driver at the desired carrier frequency.

The 200 kw rf power amplifier design and principle of operation differ considerably from the conventional power amplifiers now in general use in this country. This unit is an inverted amplifier employing two water-cooled tubes, operating push-pull.

In general, an inverted amplifier consists of a vacuum-tube circuit in which the grid of the tube is grounded and the driving excitation is applied to the cathode. The grid acts as a shield between the input circuit, which is the filament-grid circuit, and the output circuit, which is the grid-anode circuit.

Power from both the final amplifier and the driver appears in the output-load circuit, since the final amplifier is effectively in series with the driver. Therefore, power delivered to the final load circuit is equal to the sum of powers delivered by the driver and the power amplifier, less any power from the driver which might be absorbed in the power amplifier-grid circuit. A driver of higher power is required than would be necessary in the case of a class C power amplifier, but this additional power is usefully combined with that of the inverted final to produce the total output.

The main advantages of this type of circuit include: the screening effect of the grids eliminates the need for neutralization, and there is a reduction in minimum output circuit capacitance. These advantages are of exceptional value when applied to the design of a high-power international shortwave transmitter, as they result in easier operation. The neutralizing condenser assembly which must be a part of a conventional triode-power amplifier must be constructed to withstand the high voltages present and generally requires readjustment at each change in carrier frequency. The inverted-power amplifier designed requires no neu-

(Continued on page 148)



These are photographs, taken recently in a few of the rooms of the extensive research and experimental laboratories maintained by the Crosley Corp., Cincinnati, for the investigation of problems incident to the development of electronic projects. Above, part of the Chem-Mat laboratory

MODERN LABORATORY

Arrangement and equipment of research and testing facilities for war and postwar electronic projects

Few are admitted within the confines of this laboratory which is restricted and devoted to war work of a nature that is quite secret. The laboratory includes a series of several well-shielded cubicles in which engineers can concentrate without interruption on individual problems





The engineering model shop, of which this is a portion, is fully equipped with modern machine tools for the pilot production of war and postwar equipment

SET-UP



One corner of the engineering physical test laboratory, part of the engineering division

The research and engineering staff of the Crosby Corp., includes these men: Left to right (sitting), L. W. Craig, chief engineer for refrigeration and Sperry devices; R. H. Money, manager of electro and mechanical engineering; L. M. Clement, vice-president in charge of research and engineering; W. F. Fox, manager of manufacturing information; J. D. Reid, Jr., manager of research; D. B. Maxfield, administrative assistant to the vice-president in charge of engineering; (standing), L. F. Fox, manager of engineering services; M. W. Horrell, television and special studies; O. E. Norberg, engineering turrets and appliances; D. A. Sandberg, special development; B. Dempster, manager of radio engineering; Paul Klotsch, manager of automotive engineering; H. A. Bass, special aircraft radio; H. V. Noble, chief engineer, transmitters; J. H. Bussard, chief engineer, Navy devices. Below is a view of part of the laboratory devoted to component testing



ALLOCATIONS NEARER

FM broadcasters question expert deductions on public need for shift "upstairs" — Television people content

● The much-mooted frequency allocations came at least a step nearer to solidifying as a result of the February-March hearing staged in Washington by the Federal Communications Commission; it is expected and predicted that the trial balloon, originally flown by FCC on January 15 in the form a "proposed allocation" of that portion of the spectrum between 10 kc and 30,000,000 kc. may be brought down to earth as official by early this month.

In the meantime, judging by the character of the briefs filed with the commission and the nature of the oral testimony written into the record by a considerable number of witnesses representing practically every spot for which frequencies had been requested as a result of the original Radio Technical Planning Board presentation, it appears unlikely that there will be any substantial differences between the proposed and the ultimate official allocations.

Fight FM move

As was to be expected, a great deal of the argument centered around the proposal to move FM "upstairs" from its present 42-50 mc spot to another between 84 and 102 mc. The FM people are dead set against the move, and collectively they have advanced many reasons why such a shift is undesirable. The television contingent, on the other hand, appears pretty

well satisfied with their assignment, which is not greatly different from the main band they now occupy. A determined effort was made, though, by Joseph H. Ream, appearing in behalf of the Columbia Broadcasting System, to have FCC definitely designate that wideband UHF television is to be looked upon as the ultimate permanent service, and that present 6-mc services are but temporary. David B. Smith, speaking first for RTPB Panel 6 and later for Philco, offered that both concur completely with the proposed allocations and believe that FCC has done "a very satisfactory job."

Map tele stations

Television Broadcasters Association, represented by Wm. A. Roberts, of counsel, not only thought so well of the FCC apportionment as to "concur without equivocation," but presented a study to show how effective the Commission-proposed allocation might be. (See map.) Assuming service radii of 55 miles for Class A, 40 miles for Class B and 20 miles for Class C stations, the study shows that 112 of the first 140 principal marketing areas may have one or more television stations, representing a potential service to 98 million people. It shows further that 101 of the first 140 markets may have two or more stations serving 90 million people, 89 markets may have three or more stations serving 85 million people and 70 markets may have

four or more stations serving approximately 75 million people. "Thus with 12 channels it is possible to give one or more television services to a large percentage of the population of the United States." The plan would permit a total of at least 398 stations.

In this connection it became evident early in the proceedings that both the television and the FM interests already are beginning to make sheep's eyes at the still unassigned 102-108 mc band at the top of the FM allocation. TBA points out that if this space could be added to the television band, it would be possible to increase that total of 398 television stations to a grand total of 464 stations.

As little as the FM people like the 84-102 mc band that FCC would give them, they nevertheless would like that extra six megacycles running up to 108 mc for there are those who hold that even with the 80 to 100 channels that would be available for commercial and non-commercial broadcasting there still would be hardly enough room when FM really gets to going good. For the most part, though, there seems no quarrel with space allotment.

Propagation battle

The real quarrel is with the proposed location of the band, and the FM people have marshalled a truly tremendous quantity of evidence in support of their argument

(Continued on page 90)

PRODUCTION OF FM RECEIVERS CAPABLE OF TUNING THE 42-50 MC BAND

Price Range (dollars)	FM Exclusively		FM-AM Combination		FM Adaptors		Total	
	(units)	(dollars)	(units)	(dollars)	(units)	(dollars)	(units)	(dollars)
Less than \$50	975	\$43,763	1,957	\$87,086	13,916	\$628,104	16,848	\$758,953
\$50 but less than \$100	1,463	\$98,468	72,336	\$5,048,432	2,653	\$162,600	76,452	\$5,309,500
\$100 but less than \$150	2,736	\$389,750	110,176	\$13,108,838	150	\$16,500	113,062	\$13,515,088
\$150 but less than \$200	—	—	46,416	\$8,258,632	—	—	46,416	\$8,258,632
\$200 and over	8,214	\$2,835,000	134,763*	\$45,405,890*	—	—	142,977	\$48,240,890
Total†	13,388	\$3,366,981	365,648*	\$71,908,878*	16,719	\$807,204	395,755*	\$76,083,063*

Source of data: Compiled by Economics Division, Federal Communications Commission from responses to telegrams addressed to 101 manufacturers of radio receivers. *One manufacturer reported: "This includes a few sets for export but quantity is unknown." †Twenty-five companies reporting data.

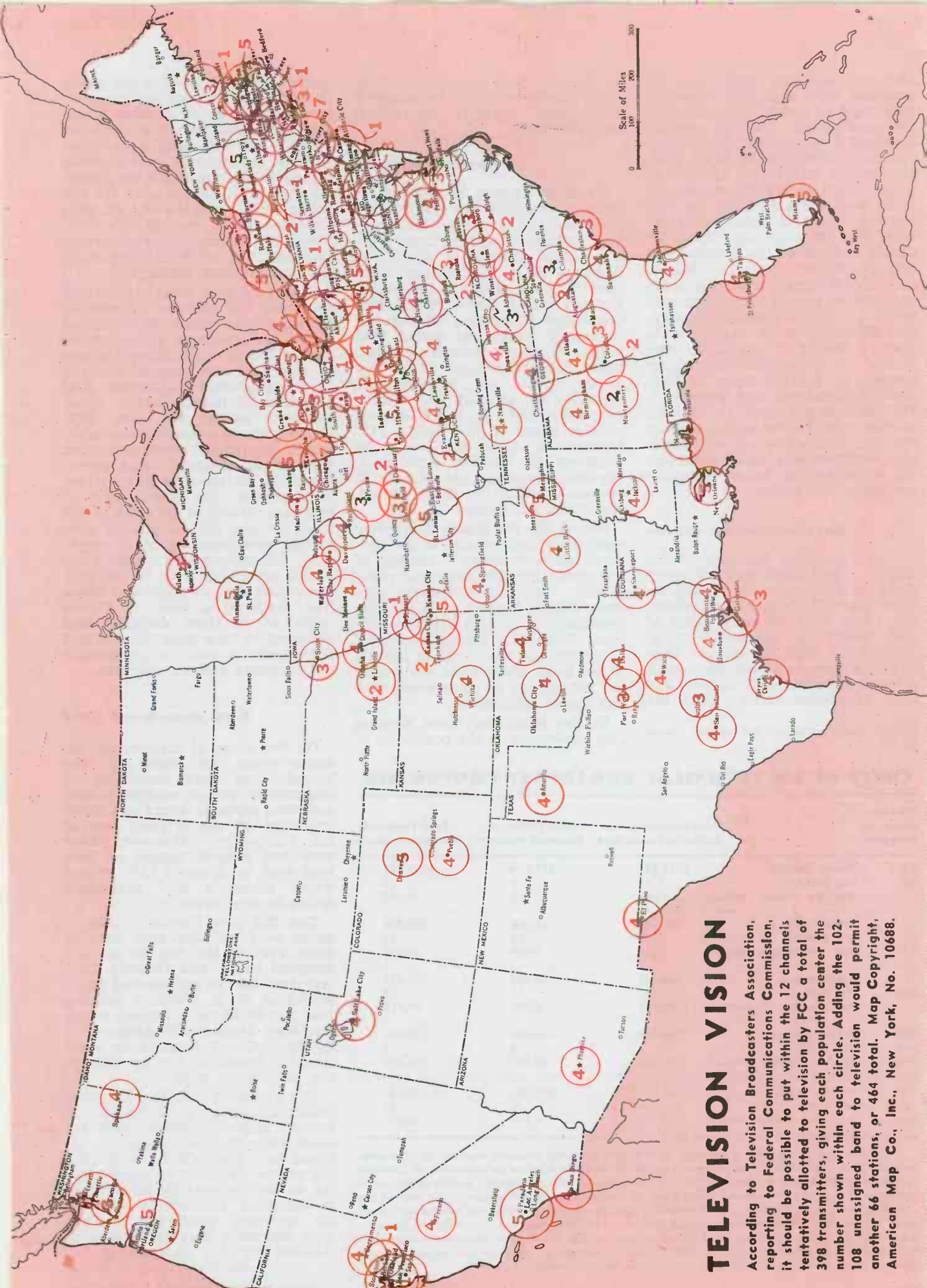

TELEVISION VISION

According to Television Broadcasters Association, reporting to Federal Communications Commission, it should be possible to put within the 12 channels tentatively allotted to television by FCC a total of 398 transmitters, giving each population center the 102-108 unassigned band to television would permit another 66 stations, or 464 total. Map Copyright, American Map Co., Inc., New York, No. 10688.

that no good can come from the proposed shift and that changing may bring no end of harm if it does any good at all. The FCC rests its case and its choice on the evidence originally presented by K. A. Norton, who is very highly thought of as an expert on the propagation of radio waves, was formerly an FCC engineer, and is now connected with the office of the Combined Chiefs of Staff of the military. It will be remembered that Norton presented findings *tending to prove that FM service in its present spot would be far more subject to service interferences of various sorts than it would if operation were shifted to a considerably higher frequency. On the basis of Norton's deliberations and deductions, FCC accordingly made its decision and let it be known that a shift in FM frequencies was not only desirable but necessary as an engineering expedient to insure adequate service to the public.

Question Norton curves

It is here that the controversy wages. The Commission engineers claim to have a basis of fact on their side; FM broadcasters affirm that they have an equal basis of fact, backed by the testimony of experts, in their contention that Norton's findings do not agree with present knowledge, if, indeed, any such knowledge exists. They say

it doesn't; that there has been little experience with the proposed band, and virtually no actual measurements.

Experts disagree

Major Armstrong has stated repeatedly that Norton's opinions are specious, and supports his argument with testimony from such acknowledged experts as Dr. H. H. Beverage, RCA Laboratories Associate Director, and Dr. Charles R. Burrows, NDRC Radio Propagation Committee Chairman. Norton, on the other hand, has stated that much of the information upon which his deductions have been made hinges on investigations made for the military and accordingly classified. In order to clear up this phase of the tangle, FCC arranged a closed meeting to be attended by Norton, Armstrong, Burrows, Beverage, Dr. Harlan T. Stetson of MIT, Dr. G. R. Picard, and Stewart L. Bailey.

Not all the FM broadcasters were completely antagonistic to the proposed move "upstairs." Leaders of the contingent that expressed satisfaction with the proposed move were Philco, Crosley, CBS, Cowles Broadcasting Co. and the Blue Network. Armstrong himself suggested a compromise move, say to the 48-66 mc band, though the suggestion did not appear to be received with any undue enthusiasm.

In the meantime there appears fair agreement on the possibility of

building FM receivers to operate in the new band at not too great an increase in cost of existing kinds. Engineers opine that it will be more difficult and will take some time; costs, it is estimated, will increase by anywhere from \$4 for the cheapest models to \$30 or more for the better kind. C. M. Jansky, Jr., representing FMBI, put it this way: "We can overcome any engineering problems, but can do nothing about the transmission medium."

There has been some controversy regarding the number of existing FM sets that would be obsoleted under the proposed plan; broadcasters, too, have complained bitterly regarding the expense involved in changing their transmitters and antennas for the new band. In an effort to get at the facts, FCC polled some 101 receiver manufacturers regarding production and the figures obtained (and reproduced in an accompanying table) indicate that the actual total of receivers produced is quite a bit short of the half a million previously mentioned in many quarters. Supplementing this data, Philco permitted it to be put into the record that this company alone had produced a total of 171,994 units, all of them designed and equipped to tune both the AM and FM bands; it built no exclusively FM receivers and no adaptors.

Seek unassigned band

On the score of transmitter revision costs (see table), it was brought out that rebuilding of transmitter, station equipment and antennas probably would cost about one-third of the original cost of the equipment. However, there were few definite figures on how long such work would take, if and when materials and manpower might become available.

The FM and television contingents were not the only ones to make eyes at the 102-108 mc unassigned band. The Forestry Conservation Service represented by its chairman, K. F. Williams, believes that the 44-78 mc allotment which has been temporarily assigned, is insufficient, and requests an additional 2 channels, 100 kc wide in the 102-108 mc band.

The facsimile people for whom Chairman John V. L. Hogan, of Panel 7, appeared, believes that A-4 modulation channels should be allotted in a spot which will permit the service "without as great a delay as will necessarily be involved in designing 470-780 mc receivers for quantity production." They urge, therefore, that FM stations be licensed for A-4 emission in the

(Continued on page 138)

*Electronic Industries for March, pages 86, 87.

COSTS OF FM TECHNICAL BROADCAST PROPERTIES

Effective Power (in kilowatts)		Total Transmitter and Radiating System Cost	Other Technical Broadcast Property*	Total Technical Broadcast Property
1.0 & less	Totals (dollars)	\$285,567	\$71,514	\$357,081
	No. Stations	18	18	18
	Ave. Per Station (dollars)	15,865	3,973	19,838
1.1 to 3.0	Totals (dollars)	259,546	29,235	288,781
	No. Stations	12	12	12
	Ave. Per Station (dollars)	21,629	2,436	24,065
10.0	Totals dollars	486,663	60,164	546,827
	No. Stations	11	11	11
	Ave. Per Station (dollars)	44,242	5,469	49,712
10.1 and over	Totals (dollars)	616,155	144,493	730,648
	No. Stations	7	7	7
	Ave. Per Station (dollars)	88,022	16,356	104,378
All Power Groups	Totals (dollars)	1,647,931	275,406	1,923,337
	No. Stations	48	48	48
	Ave. Per Station (dollars)	34,332	5,738	40,070

Original and depreciated investment in technical broadcast property reported as of December 31, 1943, classified by effective power for 38 stations adjusted to represent 48 licensees and construction permit holders. Of the 53 FM licensees and construction permit holders as of December 31, 1943, 38 reported investments in technical broadcast property. Of the 15 not reporting, 5 (all construction permit holders) were known not to have any substantial investment and doubt exists as to the extent of investment for the remaining 10. However, estimates were used for these 10 which were based on the average investment reported by stations in the same power group. *Includes other technical transmitter property and technical studio equipment. Source of data: Compiled from annual financial reports of stations.

INTERFERENCE PROBLEMS

By JOHN H. BOSE

Marcellus Hartley Research Laboratory

Reviewing some of the salient features of common channel interference for amplitude and frequency modulation

● Discussions held at the recently concluded Winter Technical Meeting of the Institute of Radio Engineers concerning the FCC frequency allocation proposal as it affects FM and television, demonstrated a need for reviewing some of the salient features of common channel interference for amplitude and frequency modulated signals.

For amplitude modulated signals, the interference of two carriers on the same frequency is well understood by the radio engineer. A ratio of desired carrier to interference of 10 to 1 at the input to the AM receiver results in a signal to interference ratio of 10 to 1 in the output. M. G. Crosby¹ reports an experimental verification of this well known fact.

If we take as a commercially satisfactory standard a minimum signal to noise ratio of 40 db, and this is conservative for high quality audio and video service, then for two amplitude modulated stations on the same frequency, within the service area of one, the signal from the other should at no time exceed 1 per cent of the carrier laid down by the first station and vice versa, if the two service areas are to be free from common channel interference.

FM characteristics

For frequency modulated signals the interference of two carriers on the same frequency is a somewhat more complicated matter.² The FM receiver, due to the operation of the limiter, is not responsive to amplitude variations in the received carrier and yields full signal output (corresponding to 100 per cent modulation in AM) only if the carrier is deviated plus and minus 75 kc. (FM broadcast practice). Interference manifests itself, if the interfering signal is strong enough to suppress or take control in the limiter, or, for weaker interfering signals, by phase modulating the desired carrier.

Let us consider the vector diagram of Fig. 1. C represents the desired carrier, I the interfering carrier, and R the instantaneous resultant. The desired carrier C is taken to be twice the interfering carrier I. If C and I are on ex-

actly the same frequency and unmodulated, the vector diagram is static. The only effect that I has on the limiter output is to change the phase.

If we now assume I to be lower in frequency than C, and we choose C as our reference vector, then I will rotate in a clockwise direction at the angular velocity corresponding to the difference in angular velocities of C and I. The amplitude at the output of the limiter is unchanged but the phase of the resultant is now rocking back and forth, + and -30 degrees, in an essentially sinusoidal manner.³

If the frequency of I is assumed higher than that of C, the same conditions obtain except that I now rotates in a counter-clockwise direction with respect to C. As long as the amplitude ratio of I to C remains constant, the phase deviation in the output of the limiter remains unchanged as the frequency of I is varied with respect to C, but the frequency of the phase modulation will be proportional to the frequency difference between C and I. The frequency deviation of the resultant in the

output of the limiter due to the phase modulation of C by I is then a linear function of the frequency difference between C and I and leads to the familiar triangular spectrum of Fig. 2.

For a carrier that is sinusoidally phase modulated, the frequency deviation resulting from such modulation is given by

$$\Delta f = \mu\phi/57.3$$

where Δf = peak frequency deviation in cycles; μ = modulating frequency in cycles; ϕ = peak phase deviation in degrees.

From this expression and Fig. 2, we can see that both the C/I ratio and the instantaneous frequency difference between C and I will determine what will be the interference output from the discriminator.

Interference ratios

For our particular example, the maximum disturbance will occur when the instantaneous frequency difference between C and I is 15 kc, that is, the upper cut-off frequency of the audio amplifier of the receiver. Using the above formula we find a value of 7,850 cycles for frequency deviation. That is, for an interfering carrier equal in amplitude to one half the desired carrier and off-set in frequency by 15 kc, our worst condition, the signal to interference ratio in the output of the discriminator will be

$$\frac{\text{Full Signal}}{\text{Interference}} = \frac{75000}{7850} = 9.55$$

The frequency of the interfering tone will be 15 kc. The action of the de-emphasis circuit following the discriminator, will be to knock this level down an additional nine times or so,⁴ bringing the signal to interference level in the output of the receiver to about 85.

If the frequency difference between C and I is reduced to 7.5 kc, the deviation at the output of the discriminator is cut in half, but at 7.5 kc the de-emphasis is only half as effective, still leaving us with a signal to interference ratio of approximately 85.

If now, instead of considering the interfering carrier as fixed, we

(Continued on page 130)

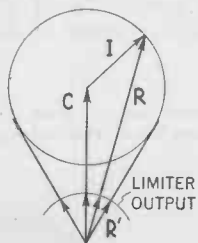
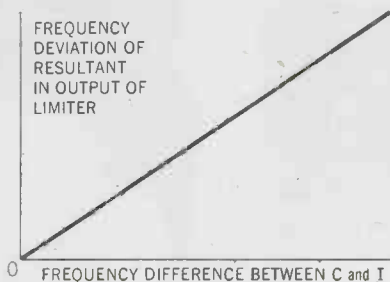
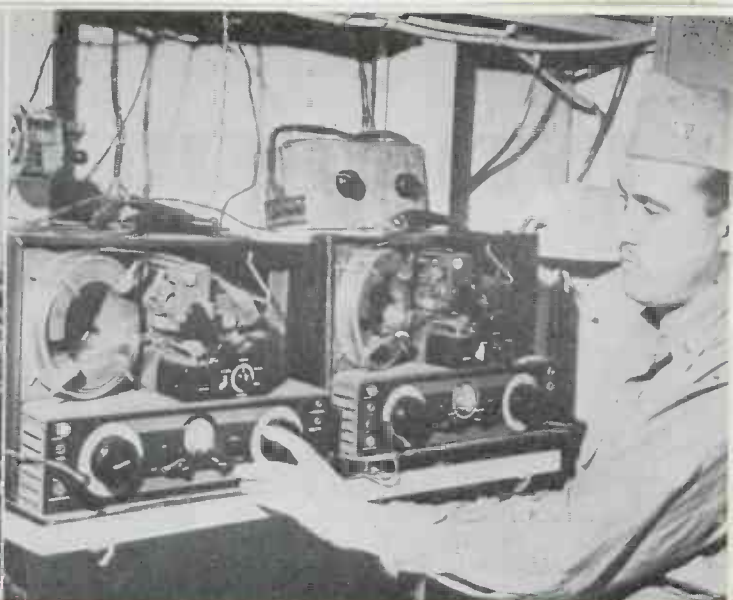

Fig. 1.—Vector diagram showing relationship between desired and interfering signal

Fig. 2.—Relation between limiter output and frequency separation of desired and interfering carriers





These two views of the Recordgraph sound recording equipment show at the left a number of instruments in use in England by SHAEF for censoring and at the right two machines in use on an escort aircraft carrier recording a sea attack against a German U-boat

MULTI-CHANNEL SOUND

Portable equipment developed for military and civilian use permits selection and playback of any of 115 parallel tracks

● The many new technical devices introduced into all phases of the military effort by the engineers and scientists of the research organizations of this country have broken down many of the older military tactical methods. In any campaign decisions and revisions regarding new methods of conducting an operation must be made instantly; it is not possible to await cold analysis as to probable results of alternate methods. Such studies, however, are ultimately made by military experts for the guidance

of others, requiring that a complete record of all circumstances of the engagement be accurately transcribed.

Toward this end great reliance is being placed on a running record of the progress of each engagement, which can be analyzed immediately if desired or shipped or stored elsewhere. This record includes not only photographs but a sound record of the views of assigned observers during the action with the comments of others who come within range of the micro-

phone, the actual orders of the officers, and many other effects that make the photographs more vivid. Some of this recorded material has been made available for education of the public as to the war's progress.

All branches of the service now have recorders of one type or another provided, and their uses increase daily. Combat reporting gave the public a seat with the U. S. Navy during the invasion of France. Similar records also have been made of battles in the Pacific. The

At the left are two views of the amplifier unit from the front and the back, and at the right the recording mechanism. For simplicity in servicing the units are separable and interchangeable with units from other machines

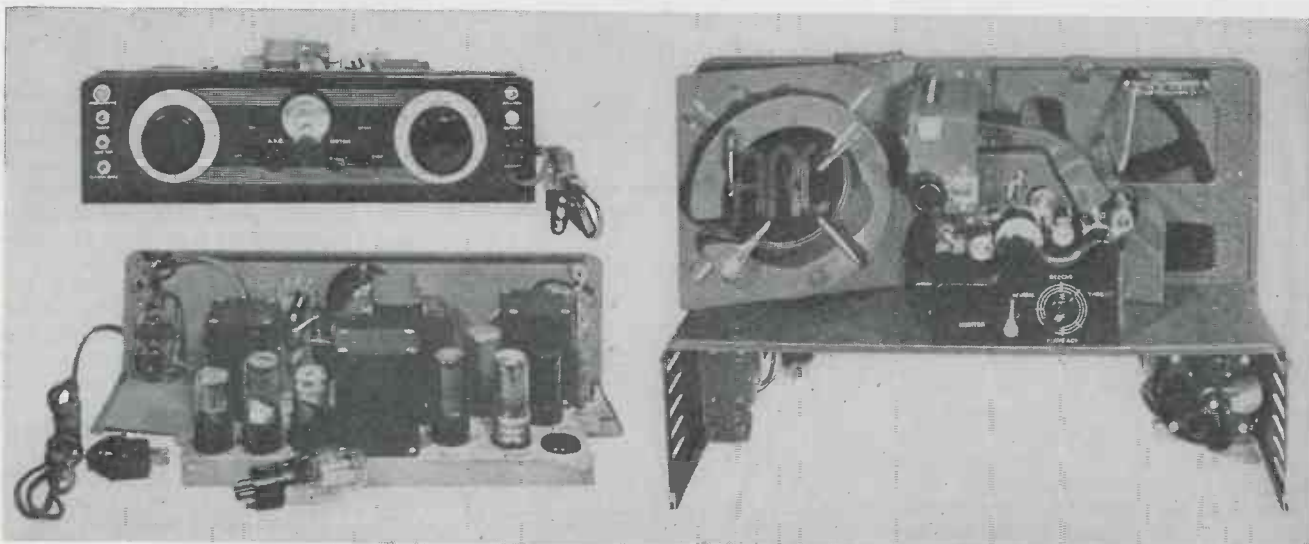

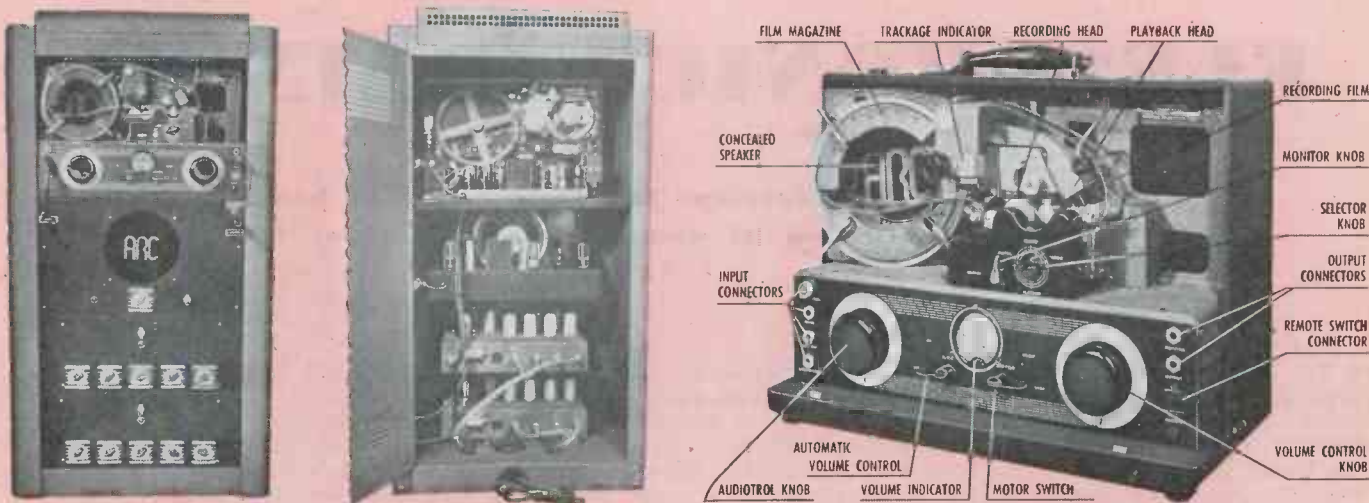

Left and center are front and rear views of the rack-mounted model with separate speaker, and amplifier unit providing for monitoring the signal as it is recorded. Right is a view of the Recordgraph with its various essential parts identified

RECORDING ON FILM

four major American networks used portable recording sets supplied by the Navy to bring the story of the storming of the Normandy beaches to their audiences.

First of the "canned" battle reports to be heard in the U. S. came from George Hicks, Blue Network announcer, aboard the flagship of a U. S. naval task force. It was broadcast at least six times by every network and innumerable times by individual radio stations. The BBC included the Hicks recording in its home report and shortwave and armed-forces broadcasts.

Operating principle

As is usual in many other fields there are several basic principles by which such recording is carried out, and the incentive of bettering the features of competition in quality, simplicity, reliability and transportability have brought about many new features that will have a bearing on many post-war activities. One form of recorder that is seeing service in many places on land, sea and air is a film recorder that operates on the same principle as the familiar record or transcription machine except that its recording needle presses or embosses grooves in parallel lines on a 50-foot film belt instead of on a disc. The film itself becomes the record, without time consuming and difficult processing details, such as developing and drying which are necessary in the phototube systems. The record can be

played back, as on a phonograph, by running a pickup needle along the embossed groove. One film belt can record about 100 minutes of sound at the normal speed (60 feet per minute) on each side of the film. For ordinary speech recording the use of a 40 ft. per minute speed, alternately available, provides a 50 per cent increase in the recording limit and still gives excellent reproduction quality.

It will be seen that this system of recording sound on film differs from recording on steel wire, a method which involves the translation of sound waves into fluctuations of a magnetic field. The latter fluctuations are recorded in the form of altered molecular patterns in a fine steel wire passed through the field. It also differs from that of the making of a sound track as on movie film. Here the sound waves are transformed electrically into light rays and photographed.

It was the Recordgraph system, a product of Frederick Hart & Co.,

New York, that was used in the invasion day broadcast mentioned above. The Recordgraph record is made on a 50 ft. continuous belt of 35 mm cellulose acetate film with a recording capacity of 5750 ft. on one side. Since both sides of the film may be used in the usual application this footage is doubled. For voice recording at a 40 ft. per minute speed, a continuous recording of approximately 5 hours may be obtained at an hourly cost of about 30 cents. The base material is fire resistant, free of abrasive and tough enough for a large number of playbacks, and requires no processing by the user. The film is supplied in a box 10 x 3 x 2 in. that makes indexing and the permanent storage a simple problem.

Continuous recording

Since the whole device is easily carried to any location, it has to be readily adaptable to any ordinary use. In order to be immediately useful any contingency can be met by switching several useful features such as the rapid change from recording to playback without rewind, or the alternate use as a public address system. It provides continuous recording, automatically following groove to groove in the film as required. The need of re-winding is avoided by a method which provides for the precise and rapid location of any particular groove of the track desired for playback.

In order to take care of all the
(Continued on page 158)

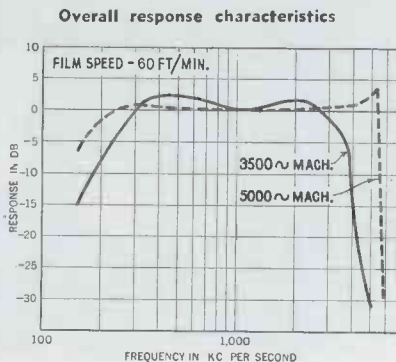

ELECTRONIC TRAINER

Navy develops full scale model of bomber for flight training of complete crews without leaving ground

● To train crews by simulating flight problems in the big twin motored flying boat, the Martin Mariner, the Navy has adopted an electronic flight trainer. This installation was developed in a year by about twenty engineers of the Bell Telephone Laboratories, and involves 220 tubes and some 8 miles of wire.

Training takes place in a duplicate of the forward part of a flying boat while an instructor at an outside desk can observe the reactions of the crew to normal flight or to artificially created emergencies such as icing, motor failure, rough air and shift of center of gravity. Even engine noises and hull vibration are duplicated, and controls have a realistically varying "feel."

The control equipment is housed in seven steel cabinets, all inter-

connected with each other and with the instructor's desk and training unit by means of cables terminated in multicontact jacks and plugs. It includes a power plant to supply 27 and 130 volt direct current for operation of relays and vacuum tubes, and 400 cycle power for operation of instruments.

In flight each instrument or control is affected by several factors acting simultaneously. For instance manifold pressure as shown on a pressure gage in the cockpit is affected by engine speed, altitude and throttle position. If therefore a voltage can be controlled by means of a potentiometer which is propor-

tional to engine speed, and added to voltages from other potentiometers, all acting as voltage dividers, proportional to altitude and throttle position, the sum of these voltages applied to a meter calibrated as a pressure gage will give a reading representing the value of manifold pressure under the conditions then supposed to exist.

The manifold pressure voltage thus obtained is used in turn to affect the readings of other meters, namely RPM, Fuel Flow and Horsepower.

Control instruments

Most instruments are direct current operated, but tachometers are run by three phase generators. These are driven by small motors run at a speed proportional to the RPM circuit voltage. A toothed

wheel geared to each motor plays over the poles of a telephone receiver to produce engine sounds. Flight instrument controls as distinguished from engine instrument controls operate on much the same principles as outlined. However since they represent motions of the airplane, control voltages must be proportional to the rate of change of the causative factor rather than to the factor itself. For example the rate of change of air speed is proportional to the thrust of the propeller, the drag of the plane through the air and the weight component along the flight path. Voltages representing these forces are summed up to change the speed of a circuit control element which thus affects the reading of the air speed indicator in a realistic manner.

This elaborate trainer was developed at the instance of Captain Luis de Florez, U.S.N.R., head of the Bureau of Aeronautics' Special Devices Division. In training on actual planes good weather is not always to be had, and some emergencies involve so much risk to plane and crew that an instructor would not deliberately create them. By rehearsing the entire crew on the ground in this trainer, its members learn to work together as a highly specialized combat team in almost any situation.

Sketch showing general arrangement of the electronically controlled training equipment at Patuxent River Naval Base; and a glimpse of one of the radio operators during a training "flight"

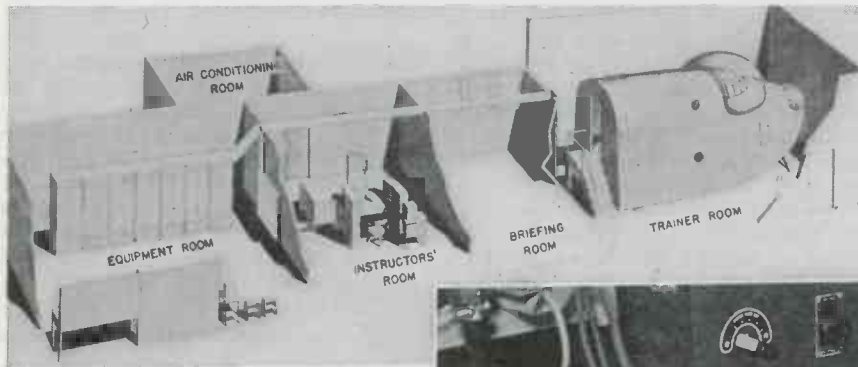

connected with each other and with the instructor's desk and training unit by means of cables terminated in multicontact jacks and plugs. It includes a power plant to supply 27 and 130 volt direct current for operation of relays and vacuum tubes, and 400 cycle power for operation of instruments.

In flight each instrument or control is affected by several factors acting simultaneously. For instance manifold pressure as shown on a pressure gage in the cockpit is affected by engine speed, altitude and throttle position. If therefore a voltage can be controlled by means of a potentiometer which is propor-

RCA REVEALS PROJECTION TELE

Large screen model incorporating ignition interference filter and high voltage tube in advance demonstration

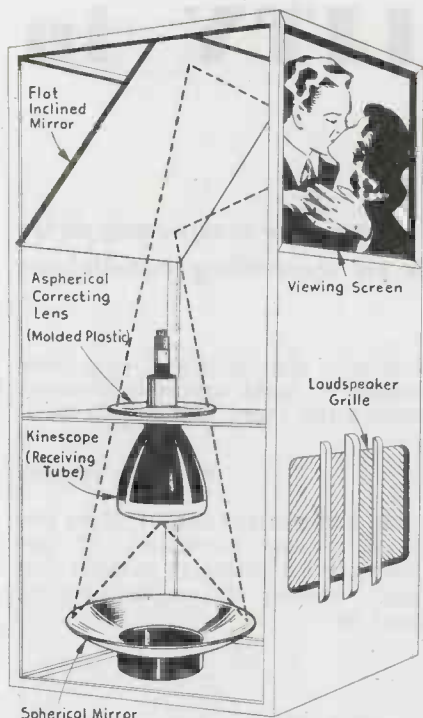

Schematic arrangement of the spherical mirror and collecting lens optical system with which projection to the viewing screen is obtained

● Kept pretty much under wraps during a long development period dating back to before the war, RCA's projection type television home receiver was revealed, middle of March, as providing brilliant pictures on a screen measuring 21 1/3 by 16 inches. The size, brilliance, clarity, and steadiness of images, have been made possible by several separate technical developments.

The two basic problems of projection television have always been:

(1) The problem of providing a cathode-ray tube capable of producing very bright pictures with the necessary resolution and,

(2) The problem of providing the most efficient optical system so as to utilize the largest possible percentage of the light generated.

Problem (2) has been solved by the development of a reflective optical system about 6 to 7 times more efficient than a good F:2 refractive lens. The optical system, in the new receiver consists primarily of a spherical front surface mirror and an aspherical correcting lens.

The mirror may be visualized as a shallow bowl, with its reflective coating on the concave surface facing the light source. The lens is flat on one side, with the opposite surface rising slightly at the center and at the edges, but depressed in the intermediate area. The system is mounted with the image end of the receiving tube facing downward through an opening in the center of the lens and facing the center

of the mirror. Images appearing on the face of the tube are picked up by the mirror and reflected through the aspherical lens to the back of the viewing screen.

Optical system

The great light gathering power of this optical system makes it possible to transfer to the viewing screen a large percentage of the light produced on the face of the tube, whereas the efficiency of a conventional projection lens in such an application is low. The function of the aspherical lens is to bring the light reflected by the mirror to a sharp focus on the screen. A major obstacle to the development of the system was the time and cost involved in making aspherical lenses from glass. RCA engineers solved the problem by devising methods and equipment for molding the lenses from a transparent plastic material.

Problem (1) has been solved largely by the development of cathode-ray tubes capable of operating at high voltages. Tubes were made in 1940 which delivered 150

candle power, as compared with 10 cp in 1935.

The high voltage cathode-ray tube used in one RCA Victor large-screen home television receiver is substantially smaller and lighter in weight than the pre-war direct-viewing picture tube. This means smaller, lighter, and less costly home receivers, and may mean lower tube replacement costs. Designed to operate at a rated voltage of 27,000 volts—nearly four times the voltage used in pre-war picture tubes—the new tubes produce a much brighter initial image. This high initial brilliance, in conjunction with the efficiency of the optical system, makes it possible to obtain from a tube with a face diameter of only five inches a bright, clear image on the screen that is more than five times as large as could be produced on a pre-war direct-viewing tube with a face diameter of 12 inches.

Two different optical problems have been overcome by special features of the viewing screen designed by RCA. It is made of a translucent plastic.

(Continued on page 146)

The advance development model of the new RCA projection type home television receiver is equipped with a translucent viewing screen measuring 21 1/3 by 16 inches



THERMAL STABILITY in

By RALPH R. BATCHER,
Consulting Editor

A survey of the most prevalent causes for frequency drift in radio receivers by changes in operating conditions

● In many of the deliberations of the RTPB panels and in the conclusions reached, the matter of frequency stability was the deciding factor in the setting of limits. Methods for the elimination of drift in transmitters have been considered for many years, and little remains to be done in this matter, at least over the prevalent pre-war frequency range, but drift in receivers is still a problem that will concern designers for some time.

In a transmitter one can take full advantage of crystal control, having only one, or at most only a few, frequencies to take care of, whereas in the usual receiver, a complete range of frequencies must be handled, making crystal control impractical. In addition, for economic reasons the cost of frequency stabilizing accessories must be kept to a much lower value than can be applied to transmitter design.

In a variable frequency tuning circuit the inductance and capacitance values are affected by temperature changes, humidity changes and by physical distortion of the elements. In precision work there are also a number of other vagaries introduced by the coupling between the variable capacitor shaft and the indicating mechanism.

When a tube is added to a tuned circuit and the other components necessary to make up an oscillator many other factors that affect frequency drift, are introduced. Capacitive changes in the tube due to temperature and to changes in operating voltages become important. The second order effect caused by the losses (which are usually neglected) causes quite important effects on frequency drift, since it is recalled that the true relation of frequency is:

$$f = \frac{\sqrt{L - CR^2}}{2\pi LC}$$

The effective resistance referred to here must include that added by losses in the tube and circuit and that introduced by the useful load. In a receiving set the operating frequency depends largely on the

frequency delivered by the oscillator. On the other hand, the load on this oscillator is not large and is more or less constant over the tuning range, so that the effect of loading on drift is less important than in other oscillator applications.

A complete list of all things that affect frequency stability would run to dozens of items, and makes one wonder how any frequency could be continuously received at all. Nature has introduced some compensation, however, since many effects have opposing trends, and it is up to clever designers to help out, by taking advantage of every expedient that will make drift effects cancel. The purpose of this article is to call attention to a few ideas that prove effective.

In the first place, it is practically impossible to set up equations and to prescribe values that will match experimental evidence from actual circuits, because of variations found with production line tuning capacitor characteristics.

If it is difficult to make predictions, why bother at all? It happens that whenever the factors that cause the vagaries in tuning are

discovered and improved, it is then possible to make useful studies regarding the more regular effects.

Spacing effects

Fig. 1 shows the layout of an ordinary tuning capacitor. If the plates are all perfectly parallel and evenly spaced the capacitance is equal to

$$C = \frac{.353 (r_1^2 - r_2^2)(N - 1)}{S}$$

assuming (N) circular plates. This value of capacitance is the least that this particular unit will ever have, as any misadjustment of spacing (S) will always increase the capacitance over this theoretical minimum. Assume that the normal spacing is set by the designer at .032 in. and that one plate is misadjusted, so that while it is still parallel with others, the spacing is .028 in. on one side and .036 in. on the other. Instead of contributing a capaci-

tance of $\left(\frac{K}{.032} + \frac{K}{.032}\right) = 62.5 K$ as

it should, it adds an amount

$$\left(\frac{K}{.028} + \frac{K}{.036}\right) = 63.6 K, \text{ an increase}$$

of about 1.8 per cent. However, since this is only one plate out of say 15, the total increment would be only 0.251 per cent, assuming the rest of the plates were perfectly adjusted. This would produce a frequency change of about 1250 cycles per megacycle. As long as this variation remained fixed no harm would result, since a calibration error and not a drift error would be introduced.

Now in any capacitor the spacing depends on maintaining a fixed relationship in an axial direction between the shaft and the stator assembly. The position of the rotor depends on the distance along the shaft from the main bearing* to the center of capacitance, upon the repeatability of the bearing and upon any radial forces that may be applied to it by the driving or indicating mechanism. For a low

Fig. 1. Outline of typical tuning capacitor frame describing dimensional values referred to in text

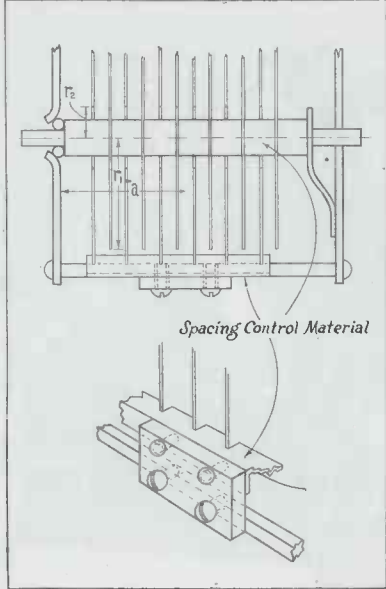

* In a two-bearing capacitor, one bearing is floating to absorb expansion stresses. The opposite bearing here is termed the main bearing.

RECEIVER OSCILLATORS

coefficient of temperature any variation in these distances and effects must be counterbalanced by the movements of the stator caused by the same temperature change, affecting the expansion of the end plates, insulating plates and metal supports. These latter provide an entirely different physical set-up and the chances are likely that a different amount of movement results.

Many of the unaccountable drifts found in some of the tuning units used in home receivers are due to designs which do not take into account inevitable expansion effects. When two different materials are used in any construction, difference in expansion always results and strains and warpage are bound to occur. A good design will always provide a point where this stress is relieved by a compliance introduced at a proper point, without introducing large capacitance shifts. It is necessary to insure that no slippage occurs under rivet or screw heads caused by forces due to strains set up at extreme temperatures. This is especially important at points where insulating plates are clamped against metal faces, since the expansion of insulating materials is usually much higher than that of any metal.

Effects of spacing

For example, suppose by some strange circumstances a 15-plate capacitor with perfect spacing of .030 in. at 70 deg. F could be obtained. Due to difference in expansion between metals, insulating plates etc., it is assumed that the rotor shaft expands 46×10^{-6} in. per degree F more than the stator assembly. A 25 deg. rise and a distance of 2 in. between the fixed bearing and the point on the shaft at the center of capacitance would produce a total shift of 0.0023 in. This spacing change would cause a capacitance change of .59 per cent or a frequency shift of 3000 cycles per megacycle. This illustrates the extent of the compensation inherent in a multiplate tuning capacitor—a 7.5 per cent change in spacing causing only a .3 per cent change in frequency.

In order to bring this about it is necessary to take care that the effect is not nullified by inadvertent neglect of some other factor. Suppose the capacitor had only 14 plates (13 airgaps). Then the uninterleaved plate would cause a

shift of

$$12 \times 0.59 + 1 \times 13$$

13

a shift $2\frac{1}{2}$ times as great.

It was mentioned above that the frequency was always lowered by any shift in the spacing from that which would be found with perfect spacing. This rule is of general interest only since in practice perfect spacing is never found. Therefore, differences in expansion might just as well improve the spacing equality (increasing the frequency) as to offset it to a greater degree (lowering the frequency). This introduces one rule followed by many designers of precision equipment*—the most precise adjustment of variable capacitors can be obtained by setting the spacing to give minimum capacitance (the highest frequency in a measuring circuit). There is sort of a plateau in the

Fig. 2. Basic tuning circuit of an oscillator or amplifier. C represents the adjustable portion of circuit capacitance; the elements with triangle prefixes are increments (either positive or negative) produced by temperature, etc.

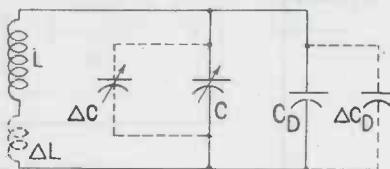

Fig. 3. Capacitance increment produced by an axial shift of rotor so that spacing differs from normal value .032 in.

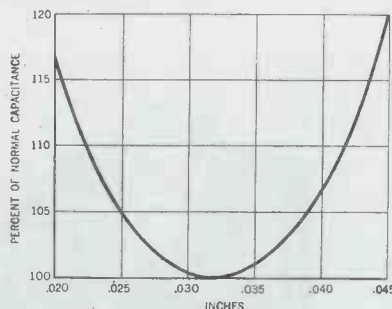
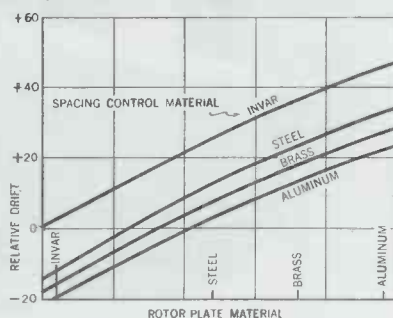

Fig. 4. Wide variety of temperature drift factors can be obtained by altering rotor plates and spacing control materials



capacitance vs. spacing curve that makes small relative movements ineffective (Fig. 3) and takes care of inevitable slight differences in manufacturing.

In many circuits it is apparent that the designers take what they think will be the easy way out in obtaining a solution to the drift problem—specifying invar plates. This metal, with a low coefficient of linear expansion over a temperature range likely to be encountered in home receiver use, has many uses but is not a cure-all if used without careful consideration, and may even exaggerate the drift problem.

Plate expansion

Suppose we disregard the shaft expansion possibility mentioned above (which, in fact, is the most important effect in many designs) and assume that equal spacing on both sides of all plates is found at all temperatures. The capacitance is proportional to the area of the enmeshed portion of the plates. Area is proportional to the square of some dimension, and the incremental change in area due to expansion is also roughly proportional to the square of the dimensional change. The metal comb, or spacers, or other means of maintaining spacing is also affected by expansion which decreases the capacitance. Technically this is stating in words the idea behind the dimensional formula for capacitance which is considered to be proportional to the first power of a dimension, and is often expressed in "centimeters."

Thus if the same metal is used for plates and spacers the capacitance value changes in accordance with the first power of the expansion factor. If the spacing control material is selected to expand twice as fast as the metal in the plates a very low overall temperature coefficient of capacitance results.

With some experimentation it is possible to duplicate the results that would be obtained from an all-invar construction using this principle. It may be mentioned that the stator plates usually have a larger radius than the rotor plates so the edges of the latter are entirely contained in the space within the stator assembly. For this reason the material used in the stator plates has but little effect on the temperature coefficient, and one needs only study the rotor plate metal. It is thus seen that there are many ways of adding corrective

(Continued on page 180)

*This principle has been followed by the Allen D. Cardwell Mfg. Corp. for many years.

REPEATER AMPLIFIER

Western Electric develops tiny three-stage equipment for unattended service on long coaxial line circuits

Although coaxial cable effects great economy in construction costs per channel, it necessitates the frequent use of repeaters along the route. Obviously, if these savings are to be realized in the overall cost of operation, the intermediate repeaters must be of the unattended type. The Western Electric D-167551 amplifier was designed to meet this requirement. Its three stages of amplification, for example, each have two vacuum tubes which operate in parallel. Two tubes must fail in the same stage of gain before transmission is lost entirely. This probability is remote. Failure of one tube in an output stage may result, at worst, in some slight degradation of service, and then only in a fully loaded system.

Although this is an improved design recently introduced, earlier designs, fundamentally the same, are still on the job at many stations and, under the pressure of war necessity, many have been called in for reconditioning instead of retirement which peacetime practice would, in all probability, have dictated. In the years ahead, television designers, mobile radio technicians, historians exploring the beginnings of super-multi channel communication, and allied specialists may well remember this am-

plifier as an outstanding milestone marking the upward path of progress in their art.

Four services

Depending upon the role it is to play in the coaxial circuit, the amplifier is built to meet four service requirements: an auxiliary amplifier, transmitting amplifier, receiving amplifier or flat gain amplifier. In general, these descriptive designations indicate the functional applications of the unit and, to some extent at least, give

an idea of the gain characteristics. The differences between the four units are effected chiefly by the configuration of the input, interstage and output networks. In other respects, the units are nearly identical.

In general, all meet extremely rigid requirements for gain characteristic, stability, impedance and modulation throughout the frequency range of 64 kc to 3 mc. All employ H. S. Black's principle of inverse feedback which makes them very stable under fluctuations of applied power voltages, and de-

Functional schematic of the amplifier which utilizes two tubes in parallel in each of its three stages as a means of preventing service interruptions

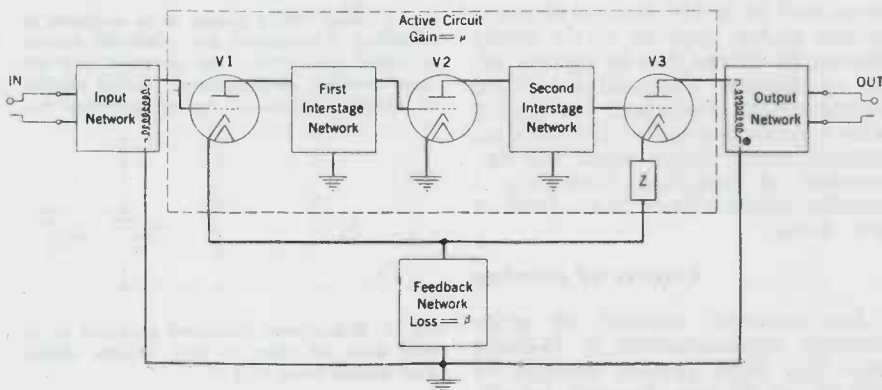

Below, type of coaxial communication line in which the amplifier is used. Right—Close up of the equipment with the case, which hermetically seals the unit, removed

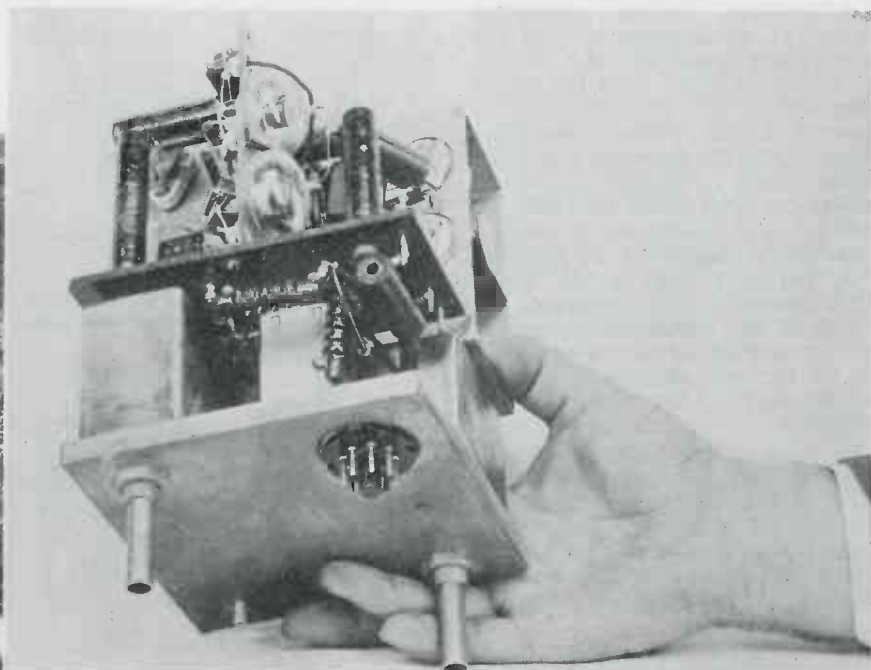

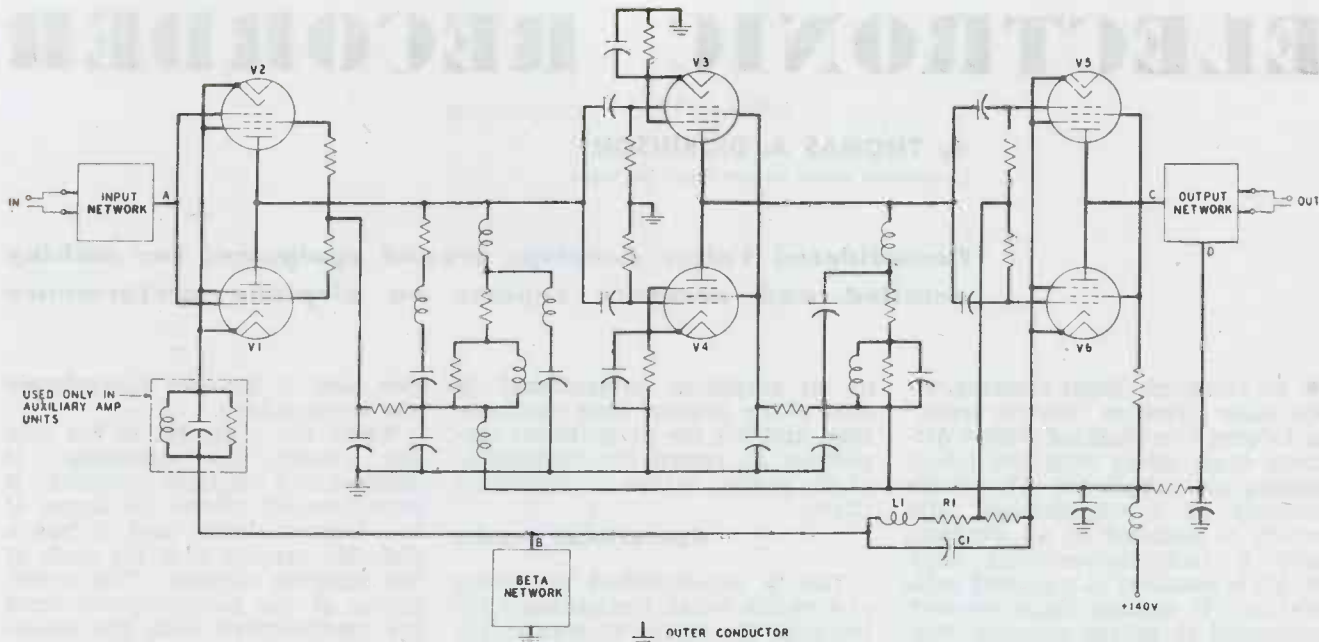

The complete amplifier within its sealed case, shown below, measures 5¼ in. square and 7 in. high. Above is a wiring diagram showing the use of tubes in parallel as a safety factor preventing interruptions to service unless both tubes in any stage fail at once

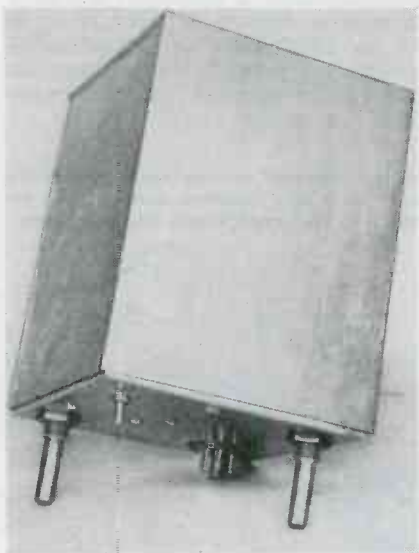

creases the effect of any ac voltages generated within the amplifier unit, such as modulation products, whether due to modulation between applied carrier frequency voltages, or to modulation of carrier frequency voltages by frequencies of the power circuits. Such stability and precise performance is dictated by the need for furnishing satisfactory transmission on circuits as long as 4,000 miles where 800 amplifiers may be operated in tandem.

Moisture, the arch enemy of unattended apparatus, was defeated in this design by methods which compare favorably with the latest wartime design practices, although the initial design goes back a matter of ten years. When the copper cover of the unit is soldered in place, during manufacture, a small bag of desiccant is placed inside.

Specially dried air is then forced through a vent and, after an immersion test, the amplifier is finally sealed. The desiccant absorbs remaining traces of moisture.

Physically, the amplifier is a small unit. It measures 5¼ in. square by 7 in. deep. Two coaxial plugs and an octal plug permit it to be interchanged readily for servicing. The unit plugs into special coaxial jacks and these, together

with the octal plug and its conventional jack, make connections to the transmission and power circuits respectively. A snap fastener is used to hold the amplifier in place. The vent tube (projection second from right in the illustration showing the closed unit) and a small hole in the top of the cover of the unit are used in the drying operation and pressure test referred to above.

MILITARY PRODUCTION SWINGS UP

The communications-radio-electronic equipment, now being secured by the Army Signal Corps, constitutes mainly replacements for the apparatus of the American and Allied forces on the western European front and United States manufacturers, especially of field telephone wire, batteries, airborne radio and radar and certain types of radio sets, tubes and batteries, are being called upon for the highest level of production in history. By and large, the deliveries have been most remarkable—February with its short month was equal to January's output and March is running ahead so far of both months.

While a number of radio-electronic manufacturers have been concerned with the future scheduling, it can be stated authoritatively that NO determination has yet been or can be made until the European fighting situation is fully delineated in regard to the Army Signal Corps requirements for the last half of 1945. On April 1 the Army Air Forces takes over all procurement of airborne radio and radar apparatus, but there will be no dis-

ruption of the existing procedures or contracts as the entire Signal Corps units handling that procurement, virtually all located at Wright Field, Dayton, will be transferred en masse to the AAF.

This assurance about the future procurement outlook, which came from the top Signal Corps leadership, was given—that the Signal Corps in the latter half of 1945 will guard against any dislocations of the communications-radio-electronic industry. The program will be to try to achieve an orderly transition from peak war production to less intensified military deliveries by degrees.

So far due to the planning of Major General William H. Harrison, Chief of the Signal Corps' Procurement and Distribution Service, and his staff leadership there has been comparatively little variation in the placement of Army orders. Probably the Signal Corps has been more closely "controlling" its communications—radio requirements and hence its stockpiles than any other procurement unit in the armed forces.

ELECTRONIC RECORDER

By **THOMAS A. DICKINSON**

Consolidated Vultee Aircraft Corp., San Diego

Consolidated Vultee develops ground equipment for making detailed and accurate reports on airplane performance

● An electronic flight recorder, vicariously styled an "electric brain," is helping Consolidated Vultee Aircraft Corp. pilots with the job of testing new airplanes. The device consists of a transmission unit, which is installed in an airplane, and a receiving-recording unit, which is installed at a ground radio station. It enables flight research personnel to obtain accurate test-flight performance data without carrying bulky camera equipment or making tedious pencil notations.

The aircraft portion of the equipment includes a number of gage devices, arranged so that various instrument indications will produce signals which can be transmitted to a conveniently-located mechanism through suitable electrical circuits. Each signal has a pre-determined travel or range, and it varies in accordance with the position of the gage device. While passing through a high-speed scanning switch mechanism in a known sequence of 40 to 90 indications per second, the varying signals modulate an alternating current in conformity with the gage indications; then the modulated alternating current is amplified, rectified, filtered, and used to produce an audio frequency signal. A small frequency modulation transmitter broadcasts the signal.

The ground-based receiver unit of the flight recorder is synchronized with the pickup equipment in the airplane, so that it can decode the audio frequency signal by amplifying and converting the signal

to an amplitude proportional to that of the original gage reading—then utilizing the proportional amplitudes to record the indications of the gaging devices on individual charts.

Operational details

This is accomplished by means of a switch which mechanically interrupts the signal at regular intervals. The switch comprises a rotating arm and a series of contacts. When the arm engages one of the contacts, a potential determined by the gage device in the airplane is fed into the electronic portion of the recording unit. There is a separate electronic circuit for each individual gage de-

vice, and it includes a condenser and electron tube.

When the potential is fed into the circuit, the condenser is charged to a negative potential. A potentiometer effects the firing of the electron tubes, and it has a slideable contact arm for each of the separate circuits. The movements of the potentiometer arms are synchronized with the movements of the interrupter switch; and, when the arm for a particular electronic circuit moves around the potentiometer a sufficient distance to pass a voltage to the circuit so as to neutralize the previously-mentioned potential or charge on the condenser, the electron tube fires.

Phantom view showing how the aircraft portion of the electronic recorder would be installed in a Liberator bomber. Below, part of the equipment which uses Teledeltos marking paper for making records, and the transmission portion of the recorder, which weighs 56 lb., complete

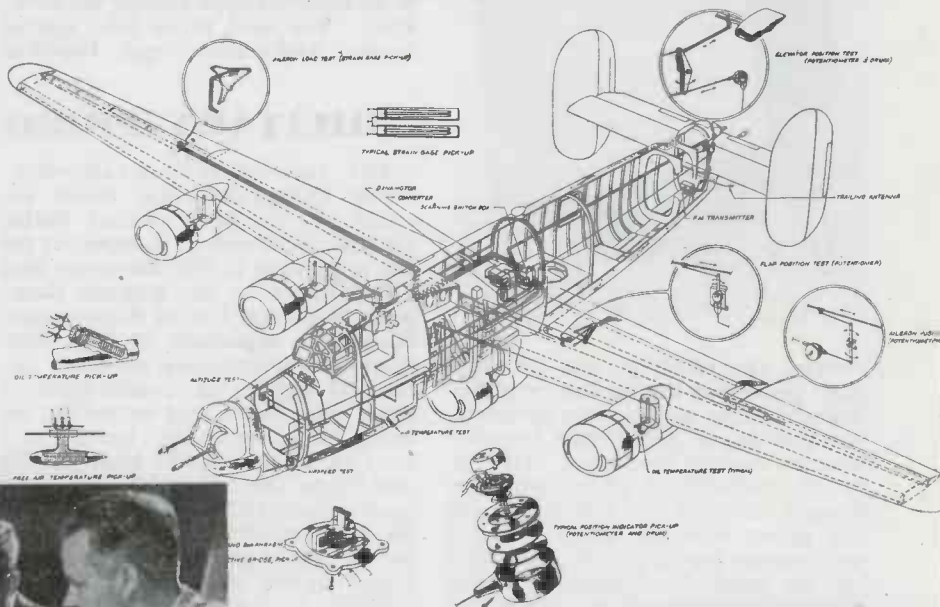

FOR FLIGHT TESTING

This action energizes an additional portion of the circuit and causes an electric pen or stylus to make a mark on the special recording paper (Western Union Teledeltos Type "L"), which reacts to a passage of current. The positions of the marking pens in the circuits are purely mechanical (i.e., the pens move continuously along a track with a wire trolley for contact with their respective circuits). Each pen circuit is actuated at a specific time during its movement across the recording paper; and, therefore, the potential originally applied to the condenser from the impulse source definitely determines the location of the pen at the time it is energized. The marking pen circuit depends on the firing of the electron tube for its operation, and it acts independently of all other circuits—arriving at the zero point of its operation as a contact associated with the circuit commences its travel on the live portion of the potentiometer.

The marking paper is fed between rollers in the recording unit so that marks will be made by the

can be readily calibrated in terms of airspeed, altitude, positions of control surfaces, etc.

Prior to the development of the flight recorder, it was customary to have members of the aircraft crew manually record pertinent data from dials, gages, and other instruments in the course of a test flight. In large aircraft, such as the Liberator and Dominator, it was possible to carry engineering observers who could do this job; but, in small fighters and pursuit planes, the test pilot himself often had to keep books. Therefore, it was frequently necessary to make dozens of test flights in order to obtain even the most simple performance data; and sometimes this was unreliable, because it is virtually impossible for human eyes and hands to keep track of all the gyrations of even a single aircraft instrument in flight.

Motion picture and "magic eye" cameras were developed for the purpose of recording instrument indications, but photography did not solve the problem for a number of reasons. The equipment required was bulky, and it was exceedingly

difficult to attain the lighting conditions necessary to make clear pictures inside of an airplane. Moreover, it was found that, at the higher altitudes, the oil on camera shutters would congeal—causing the mechanism as a whole to fail.

In these circumstances, if an experimental airplane crashed, there was less than a 50-50 chance that ground personnel would be able to determine what caused the accident; because it was likely that all clues as to the source of the trouble would be destroyed, even when the flight crew managed to survive.

Detailed reports

With the Consolidated Vultee flight recorder, it is possible to obtain a detailed and accurate report on the performance of an aircraft; and, if an accident occurs, it is virtually certain that ground engineers can determine why. Besides this—with all its gages, switches, converter, and transmitter—the aircraft portion of the flight recorder weighs only 56 lbs. and occupies only four cubic feet of space. Even the smallest engineering observer would weigh more and take up more space.

The flight recorder was invented and perfected by Harvey D. Giffen, Thomas B. Thomson, Jr., and Willard C. North—all flight research engineers for Consolidated Vultee at San Diego, California. The development work required approximately three years' time.

Left is a schematic of the functions of the ground-based receiving-recording unit of the flight recorder. Below is a diagram showing how the transmission unit functions in connection with an airspeed pickup or gaging device

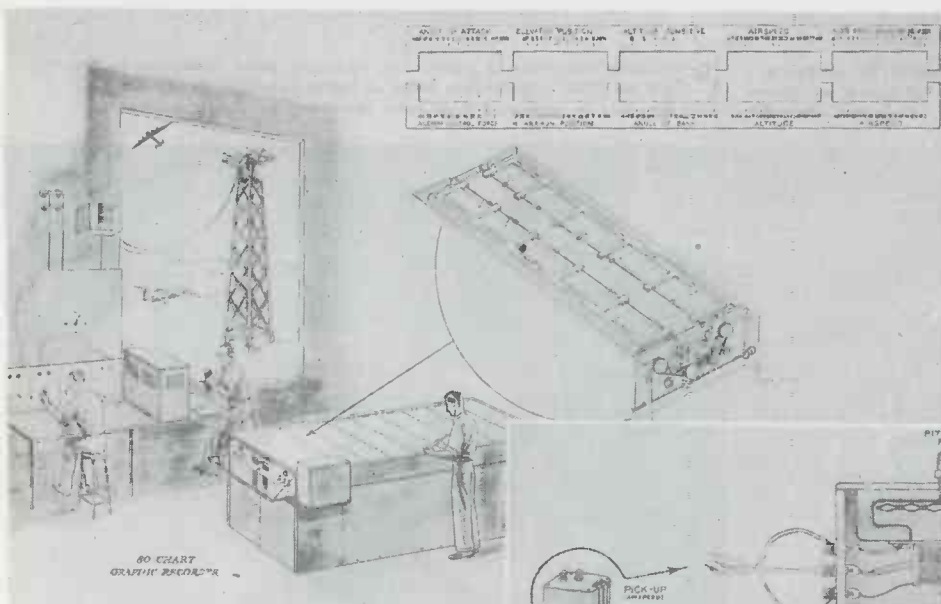

pens at definite intervals, according to the time that elapses between impulses at the transmitter. This makes it possible to place time lines on the paper, and allows the plotting of two-dimensional graphs with time and position or other ordinates; and thus ground engineers can obtain true reproductions of the movements of gaging devices in the airplane. The graphs

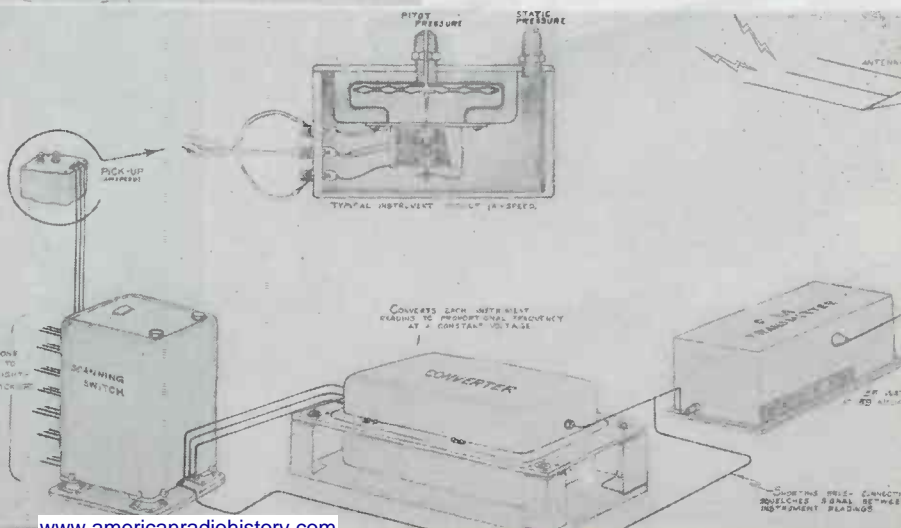

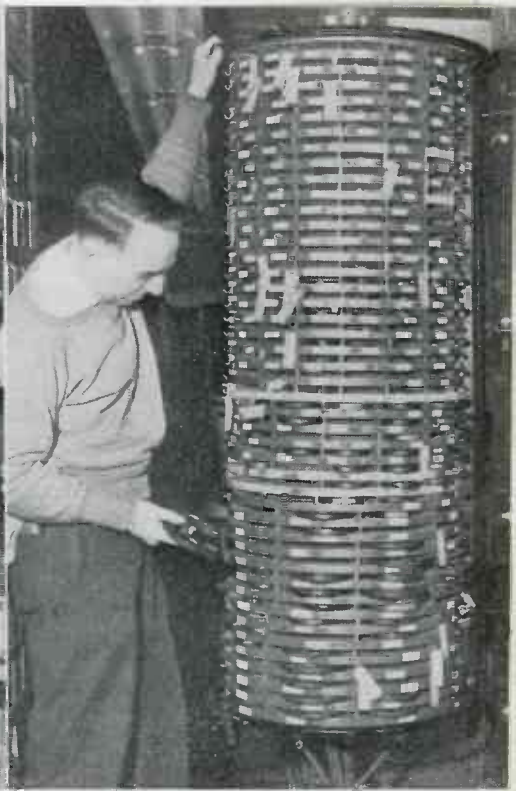
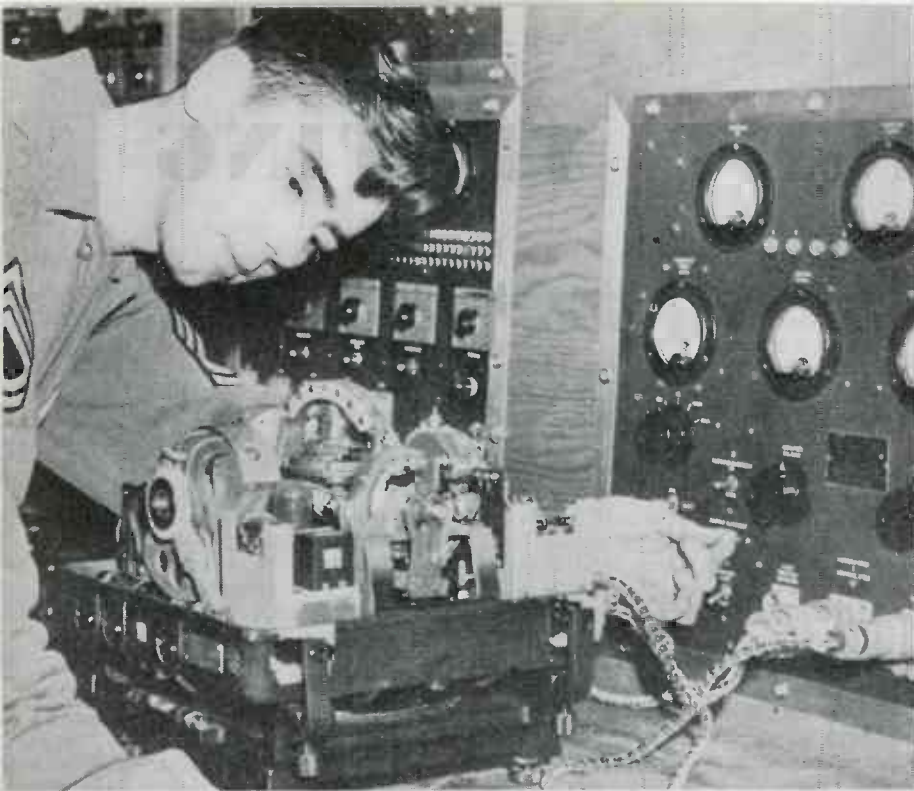

1—A 500% repair time saving results from field use of a complete test panel for Sperry electronic gyropilots. Six tests are possible. A continuity checker and gyro analyzer are provided. Entire assembly is mounted on a six foot square board. Its use eliminates returns from front to factory.

2—Tier of circular wooden shelves mounted on a turntable provides storage for 400 snap gages at General Electric's Fort Edward plant. Shelves are variously spaced.

9 PRODUCTION LINE

4—Lead screw threads can be reconditioned quickly by clamping a cutting tool to the lead screw nut with a lathe dog as shown. Screw is driven while nut is held by lever (1). General Electric Co.

5—Brazing technique is applied in fastening plate connector to the cap on 833A transmitting tubes at North American Philips Co., Inc. Operator is protected from tube shattering by plastic screen.

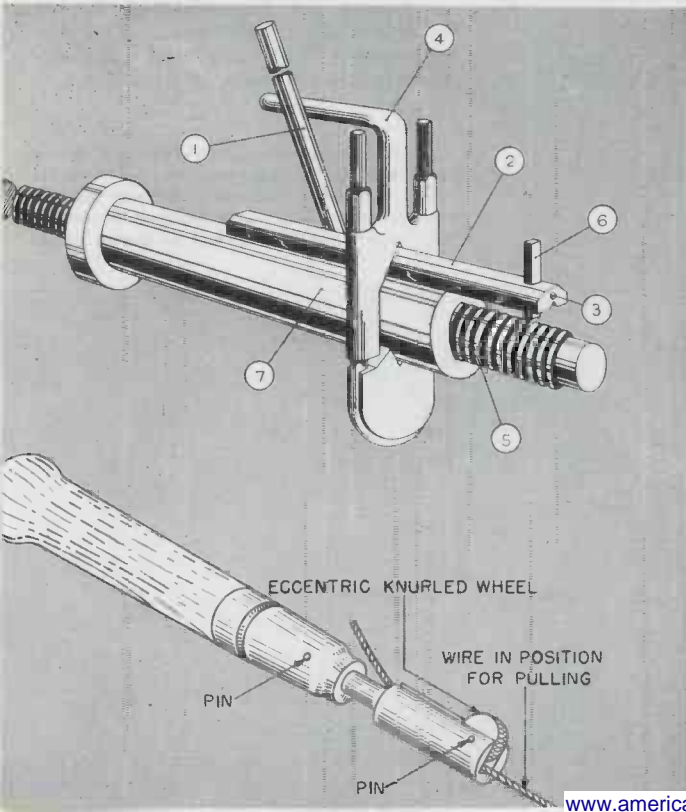

EGCENTRIC KNUFLED WHEEL

WIRE IN POSITION FOR PULLING

PIN

PIN

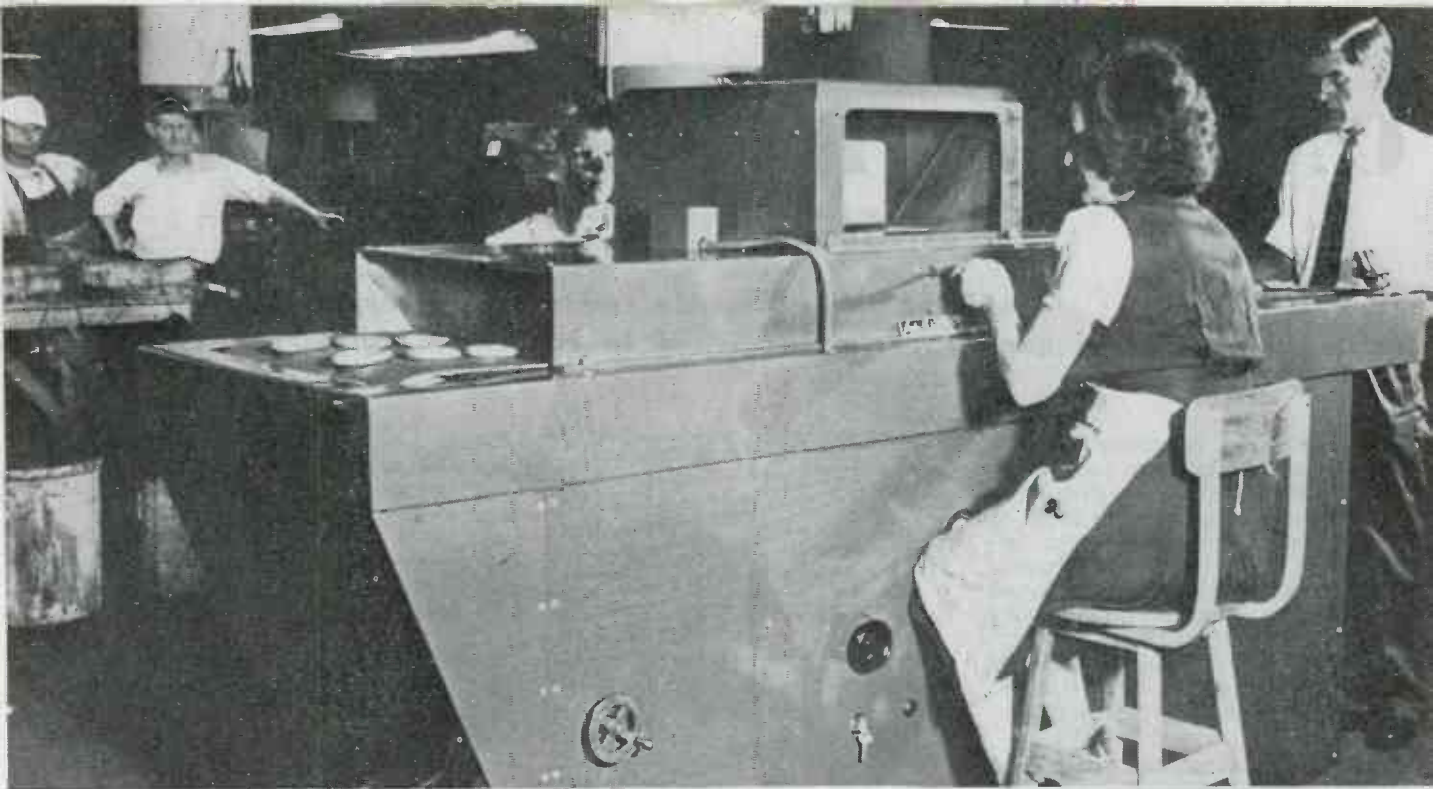

3—Rapid inspection is made possible by this new X-ray fluoroscopic inspection machine. A conveyor belt feeds the pieces under the indirect fluoroscopic head. Operators can be positioned on both side of the machine and can mark defective pieces without stopping the conveyor. North American Philips Co., Inc., New York.

SHORT CUTS

6—Glenn L. Martin Co. communications systems in electric turrets now are tested by a new electronic bridge resulting in savings ▼ of 600 per cent in time.

8—Small wires are fused together at General Electric Company by first dipping moistened ends in an equal mixture of filed silver solder and borax flux. ►

7—Tensioned locking wires are easily tightened by women with puller shown. A knurled eccentric wheel increases the grip ◀ as the tool is pulled harder.

9—Well built custom designed test jig permits rapid testing of many properties of dynamotors coming off production line at ▼ Carter Motor Company, Chicago, Ill.

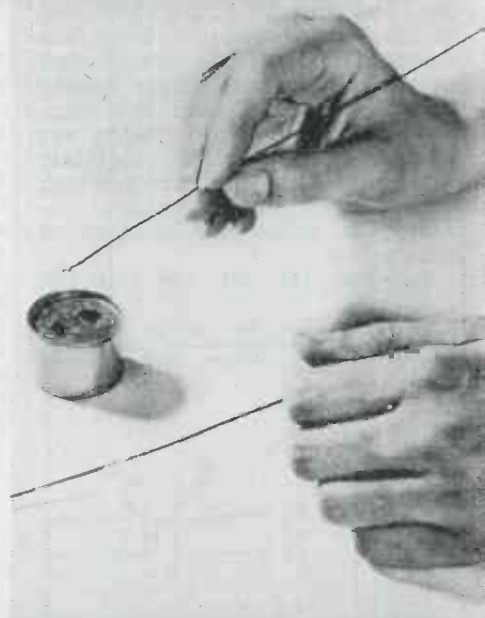

CAVITY RESONATORS

By W. DAELLENBACH*

Analyzing the resonance conditions, energy losses and frequency variations found in concentric cylindrical cavities

This form of resonator is quite widely used in modern centimeter and decimeter ranges. The cross sections of the particular form of resonators treated is shown in figures 1 to 4; a is the axis of rotational symmetry, C is a lumped capacitance; its value includes the stray capacitance of the adjacent resonator section. In the case of velocity-modulation, an electron beam traverses this lumped capacitance.

Resonance condition, total field energy, energy losses due to heating, and frequency deviation due to the passing electron beam are studied. The rather complicated expressions derived, which involve combinations of Bessel functions, are broken down and graphs are plotted to considerably facilitate their numerical evaluation which can then be effected without recourse to tables of functions or similar aids.

In cases (1), (3), (5) and (7),

*Abstracted from the German (Hochfrequenztechnik und Elektroakustik, Leipzig, Vol. 61, No. 5), by J. Zentner, Ph.D., Associate Editor.

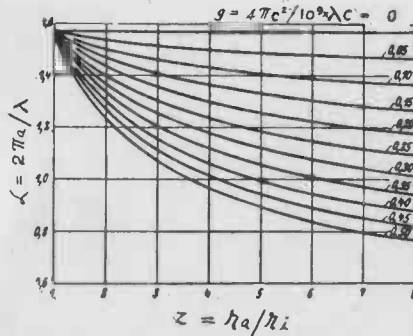

Fig. 5—Graph showing wavelength-dimensions relationship for elongated resonators

where the resonator radius is small compared to its length, the resonators are considered as coaxial transmission lines terminated by a capacitance C ; at resonance, there will be a matched termination. The electric field, which extends at right angles to the axis of rotational symmetry, varies as a sine function along the axis of rotational symmetry. Cases (2), (4), (6) and (8), where the resonator radius is large compared to its length, are treated in a similar way; the electric field will now vary as a Bessel function.

Elongated resonators

For the first group of resonators (1), (3), (5) and (7), the resonance condition is given by:

$$g \ln z \tan \alpha = \frac{4\pi^2}{10^9} \lambda C \ln \frac{r_a}{r_i} \tan \frac{2\pi a}{\lambda} = 1,$$

where

$$\alpha = 2\pi a / \lambda, \quad z = r_a / r_i, \quad g = \frac{4\pi^2}{10^9} \lambda C.$$

Figs. 1, 2, 3, 4—(Left top and bottom, below and right)—Resonator shapes

Figure 5 represents a graph of this equation with g as parameter.

Expressions for the total field energy E , as well as for the wasted energy N , due to the resistivity ρ of the material, which is converted into heat, are computed and graphs are given.

The ratio $h = NT/E$ (the ratio of the energy lost during one cycle to the total field energy, or $2\pi/Q$) is computed; T is the duration of one cycle.

$$h = \frac{240\pi^2 \rho}{t} \frac{1+z}{\ln z} \left[\frac{P(z)}{Q(z)} + \frac{1}{\epsilon a} \right],$$

where

$$\epsilon a = 2\pi r_a / \lambda, \quad t = (\rho / 2\pi \cdot 10^{-9} \mu \omega)^{1/2},$$

$$P_1(z) = \frac{1}{\ln z} + 2g^2 \ln z,$$

$$Q_1(z) = \frac{1+z}{2} \left[\frac{g}{\ln z} + \left(g^2 + \frac{1}{\ln^2 z} \right) \times \right.$$

$$\left. \cot^{-1} (g \ln z) \right],$$

$$P_3(z) = 2 \left[\frac{r}{\ln z} + g^2 \ln z \right],$$

$$Q_3(z) = (1+z) \left[\frac{g}{\ln z} + \left(g^2 + \frac{1}{\ln^2 z} \right) \times \right.$$

$$\left. \cot^{-1} (g \ln z) \right].$$

The penetration depth of the currents is designated by t ; Q and P are given by the functions Q_i , P_i .

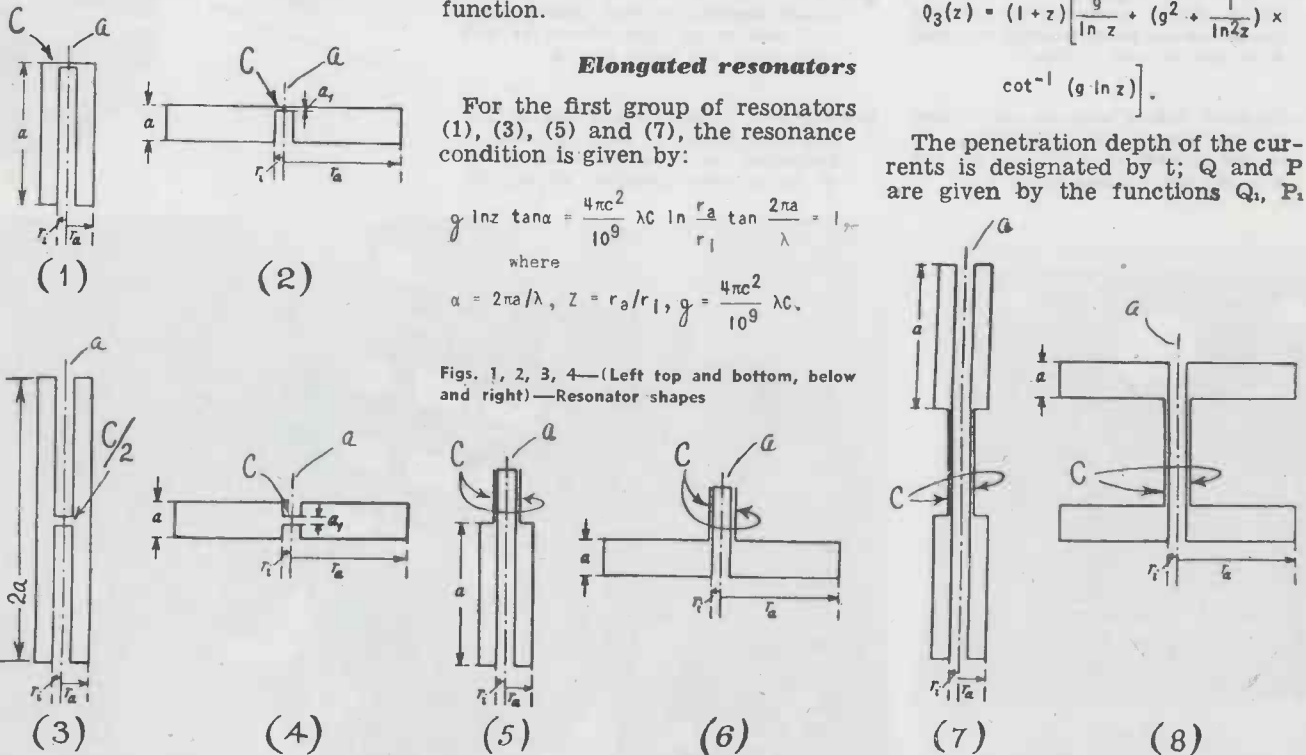

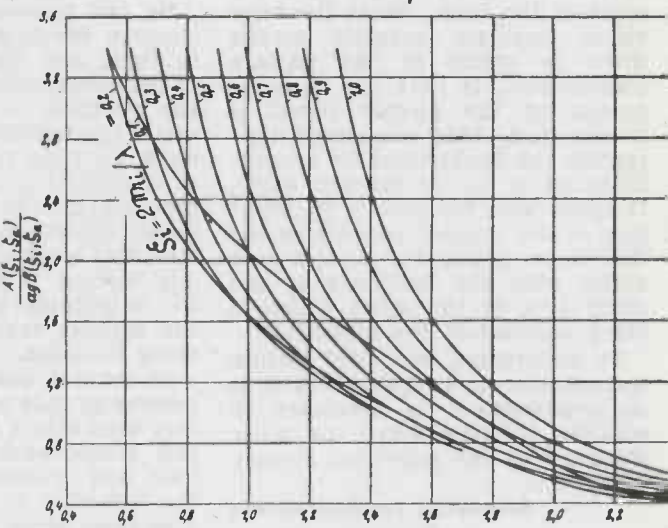
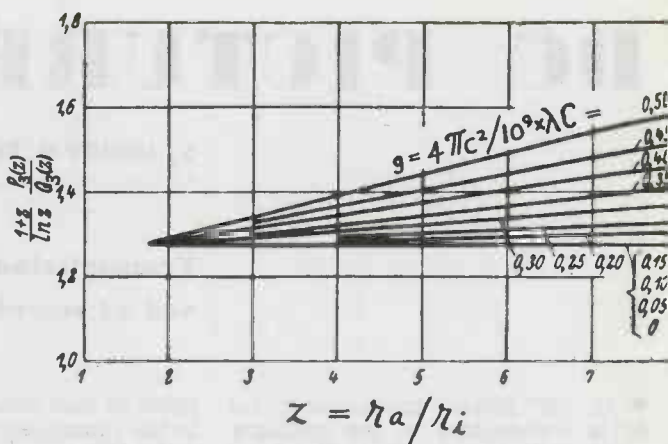
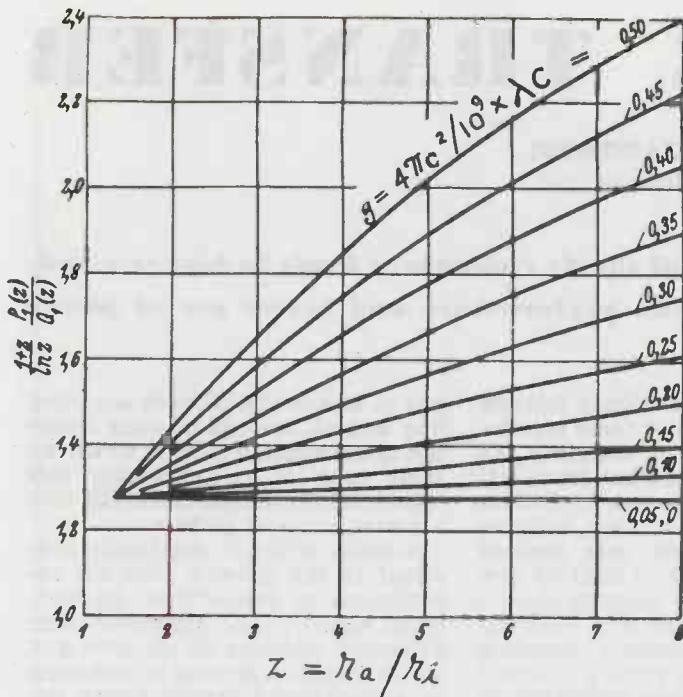

or Q_a, P_a for the resonators designated (1) and (3), respectively. Resonator (5) is identical with resonator (1), and resonator (7) corresponds to two type (1) resonators; however, the energy ratio considered here will be the same for both types. The two graphs in figures 6 and 7 will assist in the use of the equations.

The frequency deviation of a generator upon modulation by the passage of an electron beam of varying intensity is next considered. If V_c is the voltage across the lumped capacitance, and δI_c the amplitude of the capacitive component of the electron current through it, the following relation exists:

$$C\delta\omega V_c / \delta I_c = - \frac{1}{1 + \frac{\sin(2\alpha)}{2\alpha}}$$

The equation is plotted in figure 8.

Flat resonators

Flat resonator (6) is practically identical with resonator (2), and resonators (4) and (8) are equivalent to two resonators (2) joined together. Polar coordinates are introduced for the treatment of resonator (2), and expressions for its behavior are derived.

The resonant wavelength and the dimensions of the resonator are related by the following equation:

$$\alpha g = \frac{8\pi^2 c^2}{10^9} aC = \zeta_1 \frac{Z_1(\zeta_1)}{Z_0(\zeta_1)},$$

where

$$\zeta_i = 2\pi n_i / \lambda,$$

$$\zeta_a = 2\pi n_a / \lambda.$$

Figs. 6, 7—(Top left and right) — Graphs assisting in evaluation of relative energy loss in elongated resonators Fig. 10 — (Right) — Graph assisting in evaluation of relative energy loss in flat resonators

where Z_0 and Z_1 stand for combinations of Bessel functions. Numerical values will be readily found from figure 9.

For this type resonator, the ratio h of the energy lost during one cycle to the total field energy, $(2\pi/Q)$, is equal to:

$$h = \frac{480\pi^2 p g}{t} \left[\frac{A(\zeta_1, \zeta_a)}{\alpha g B(\zeta_1, \zeta_a) + \frac{1}{a}} \right],$$

where

$$B(\zeta_1, \zeta_a) = \left(\frac{\zeta_a Z_1(\zeta_a)}{r_1 Z_1(\zeta_1)} \right)^2 - 1 + \frac{2}{\alpha g} - \left(\frac{\zeta_1}{\alpha g} \right)^2,$$

$$A(\zeta_1, \zeta_a) = \alpha g \left[\frac{1}{\zeta_a} \left(\frac{r_a Z_1(\zeta_a)}{r_1 Z_1(\zeta_1)} \right)^2 + \frac{1}{\zeta_1} \right].$$

Fig. 8—Graph illustrating wavelength-modulating electron stream relation in a magnetron with elongated resonator

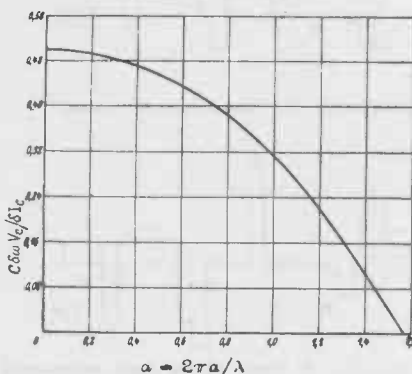
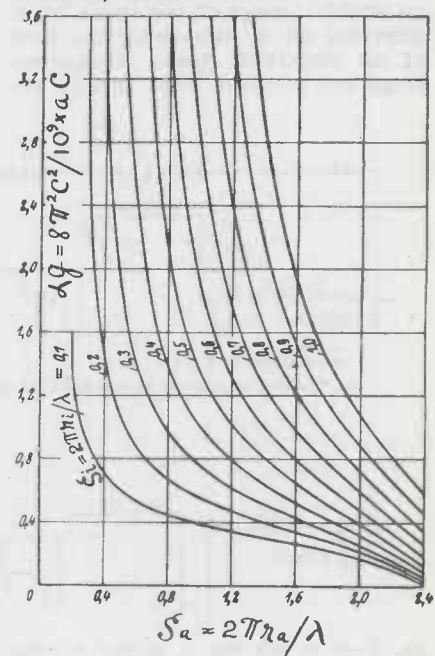

Fig. 10 will help to find this ratio for any particular resonator. Finally, the change in wavelength due to the transition of an electron current at the lumped ca-

(Continued on page 162)

Fig. 9—Graph showing wavelength-dimensionless relationship for flat resonators



DC PICTURE TRANSFER

by HENRY N. KOZANOWSKI

Television Engineering Department, RCA

Transmission of the dc component leads to higher standard of television performance and better use of power

● In "dc" picture transmission, no dc is transmitted in the ordinary sense of the term. What the television engineer actually means when he speaks of "dc" picture transmission, is that the dc component of the picture signal is transmitted. This component represents the background or average illumination of the original scene. It varies with the overall illumination of the original scene, whereas the video signal (ac component) varies with the brilliance of the small area of the scene which is being scanned at the moment.

To understand why "dc" picture transmission is used and how it is accomplished, it is necessary to consider in some detail the inner workings of the television system.

Scanning fundamentals

To begin with, we can imagine a general television pickup tube. All that we have to know about this tube at the present time is that in some way it is able to translate light variations into corresponding variations of electrical voltage. In practically all such tubes in use at the present time, this translation process is carried out by focusing an optical image of the scene to be televised on a light-sensitive area of an electronic tube. Photoelectrons are emitted from various re-

gions of this area in direct relation to the illumination of these regions.

By the process of scanning, an electron beam, deflected from left to right and from top to bottom of this rectangular surface, replaces the electrons which were emitted under the influence of light by new electrons from the electron stream in an orderly fashion. The electrons replaced by this orderly scanning procedure actually form a complex electrical wave whose amplitude at any instant is directly related to the brightness at that instant of the definite region of the picture being televised.

In general, one can think of the process as that of dividing the picture area into a series of very narrow strips, each a scanning line long, and of marking on each strip the effective illumination of the area from which it was taken. This strip-series in television is the succession of elementary scanning lines and the markings are the instantaneous voltages along these lines.

Assume for the moment that we know how to make an electrical signal which will vary in time in such a manner that its voltage at any instant corresponds precisely to the brightness of the scene element from which this voltage was formed by photoelectric action. Assume also that we know how to

put in at the end of each scanning line and at the end of each frame the synchronizing signals which we shall need in re-assembling this electrical information faithfully into a visual scene or picture.

A device which is practically universal at the present time for reproducing an image from an electrical signal is the kinescope. The kinescope contains an electron gun which shoots a stream of electrons at a fluorescent screen under the influence of a high dc voltage. The electron stream is deflected from left to right and from top to bottom either magnetically or electrostatically. By means of the synchronizing signal which we introduced into the system, it is possible to make the electron beam start at the left of the kinescope, continue to the right side, return to the left and so on, exactly in synchronism with the original scanning at the pickup device.

Brightness variation

When electrons strike the screen their energy is converted into a fluorescence of the screen itself, the screen brightness at a given region depending directly on the number of electrons striking it at a given instant. In the kinescope the grid which surrounds the electron gun acts as a valve controlling the number of electrons in the electron stream. A high negative bias will cut off the beam completely and produce no light on the end of the kinescope while a grid voltage close to zero will allow full beam current to flow and produce the maximum possible illumination. Intermediate brightness will be produced by voltages located between the two extremes, zero bias for full white, and cutoff bias for full black.

If the signal which is obtained from the pickup device is magnified without any distortion and applied to a kinescope grid, we see that a sufficient mechanism exists to produce a picture which is a faithful reproduction of the object being televised. If this signal has a polarity such that black is represented by a definite negative voltage and white by a voltage practically zero, this voltage magnified and applied

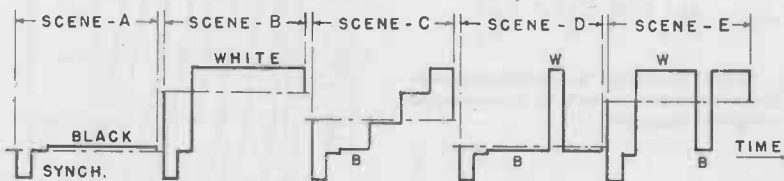

Fig. 1—One horizontal line samples of simplified signals for various types of scenes

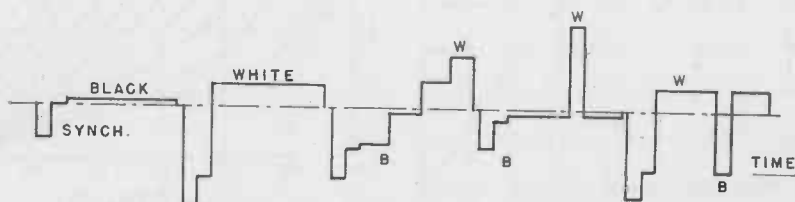

Fig. 2—If dc grid bias is adjusted to value of ac axis, all tones will be truly represented

to the kinescope grid will cause the light intensity to change so as to follow the change of illumination in the object being scanned.

It is now necessary to explain the meaning of black level, white level, synch. pulse (blacker than black) and to consider intermediate illumination values. Fig. 1 shows one-cycle samples of simplified typical signals for various types of scenes. Black level, B, white level, W, a stair-step wedge, a white bar on black background, and a black bar on white background are shown successively. Each wave includes blanking and synchronizing pulses.

Signal translation

To get a true picture at the kinescope, these voltages, correct in absolute value, must be applied to the grid of the kinescope after all the intermediate processes of modulation, transmission, and reception in the various circuits have been accomplished. In other words, a kinescope has only one value of grid voltage at which it is dark, and another voltage at which it delivers full illumination, and it is the duty of all the intermediate transmission and reception processes to translate the television signal into absolute voltage levels at the kinescope grid.

If we amplify a television signal which is a series of wave trains of the elementary forms shown in Fig. 1, it is obviously impractical to use multi-stage dc amplifiers. However, as soon as a wave of this type is applied to an amplifier grid through a condenser, it is changed electrically; in fact, we must now talk about an ac signal axis.

By its very concept, the ac axis is located so that during any given cycle the area of the wave above it is equal to the area below it. This is just another way of saying that the product of current and time in one direction is equal to the product of current and time in the opposite direction during one cycle and there is no component. The dc wave forms of Fig. 1 balance themselves about the ac axis to give the symmetry shown in Fig. 2. It is important and essential to point out that peak-to-peak voltage values are completely and faithfully preserved in the process. If the wave forms in Fig. 1 are applied to a kinescope grid through a coupling condenser from the output circuit of a video amplifier, the instantaneous voltage of the grid varies about the ac axis as shown in Fig. 2.

It is immediately apparent that although the peak-to-peak values of the wave forms are maintained, the absolute value measured at the grid changes with time, depending entirely upon the picture content. On the kinescope this will mean that, with an arbitrarily selected

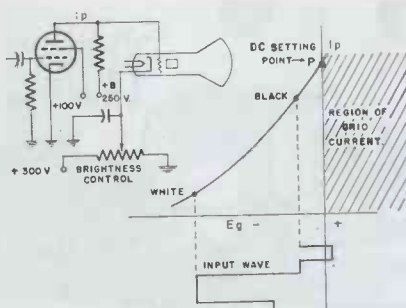

Fig. 3—Circuit for "dc setting"

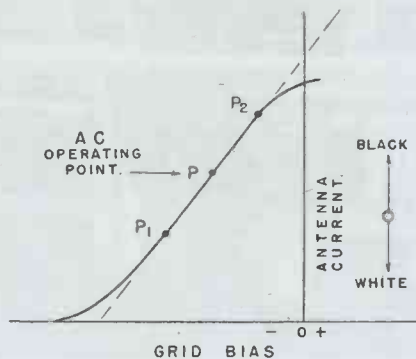

Fig. 4—Operating curve for grid-bias modulated amplifier

grid bias voltage which is varied by the picture signal, either the white components or the black components can be compressed as the average picture content changes.

As a simple illustration, let us consider the stair-case wave form "C" of Fig. 2. If the dc grid bias is adjusted to the value given by the ac axis, white, gray and black will be quite truly represented because the picture of the stair step wedge is practically symmetrical. If, without changing the dc bias, the wave form "D" is applied, the white will

be saturated and what should be black will appear as gray. If the wave form "E" is applied, the black will be saturated and what should be white will appear as gray. This state of affairs can be summarized by saying that the picture will "bloom" in the highlights or "squash" in the blacks and, only accidentally, as in the relatively symmetrical wave form "C," will the correct illumination range of the picture be faithfully reproduced.

It is easy to go a step further in the analysis by noting that the absolute wave forms of Fig. 1 can be obtained from the ac wave form of Fig. 2 by a simple process known as dc setting. This dc setting process merely pushes all synchronizing or blanking pulse peaks to the same operating point on a vacuum tube characteristic.

DC setting

One method of dc setting is to allow the amplifier tube to take grid current at the peak of the synchronizing portion of the wave. A circuit which can be used for this purpose is shown in Fig. 3. In this case the video signal, with synch. pulses having positive polarity, is applied to the grid of the video output tube.

On initial application of the signal, the grid is driven positive by the synch. pulse peaks. Electrons flowing to the grid will charge the grid side of the coupling condenser negatively. During the interval between successive synch. pulses, this charge can leave the coupling condenser only through the high resistance grid leak, developing a negative bias which is practically constant. Successive synch. pulses,

(Continued on page 140)

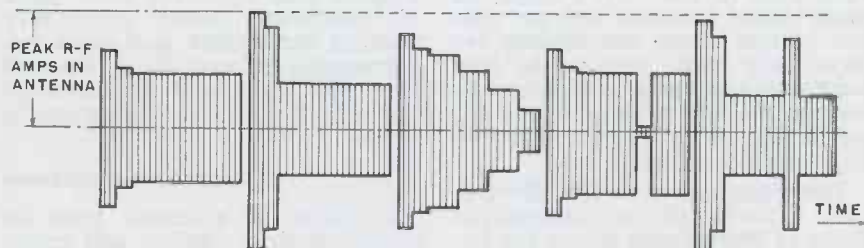

Fig. 5—RF envelope of the picture wave when ac transmission is used

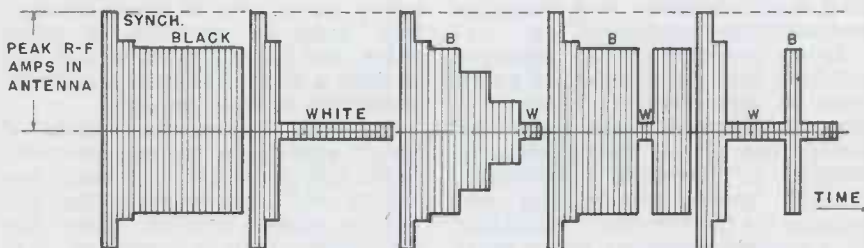
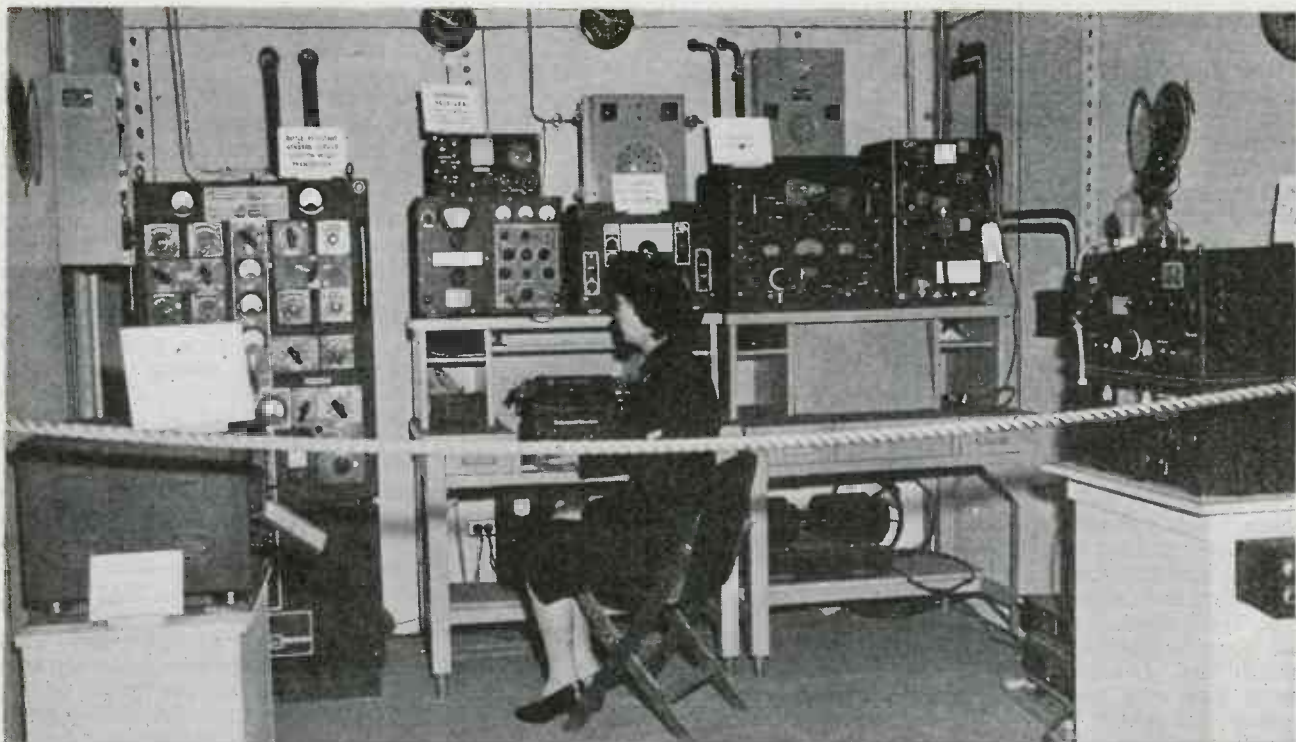

Fig. 6—Appearance of the envelope when dc picture transmission is used



Some idea of the great amount of radio communicating equipment required on a modern ship in the Navy is indicated by this simulated radio room which was set up as part of the Navy Electronic Exhibit staged during the latter part of November in Chicago; no radar or sonar gear is shown

NAVY RADIO EQUIPMENT

Installation and maintenance of radar, sonar and communication apparatus requires services of approximately 75,000 technicians

● The problem of installing and maintaining the tremendous amount of radio, radar and sonar equipment in the Navy's ships, its many shore stations, and on special Marine Corps amphibious vehicles and bases, emphasizes how a difficult and complex task can be accomplished by teamwork and coordinated effort on the part of thousands of workers.

The story starts in the Electronics Division of the Bureau of Ships at Washington where the Installation and Maintenance Branch, headed by Comdr. H. E. Bernstein, USN, does all the planning and staff work necessary to a complete and accurate installation job.

As an example of the planning required, consider the case of a new class of destroyers on which it is planned to install radio, radar and sonar gear. First, the problem of weight is involved. Antennas, cabling, power supply and apparatus for the complex installation on a modern destroyer add a great deal of weight to the ship, some of

it well above the keel. Stability of the ship must be safeguarded by careful study of the proposed weights and locations, each piece of equipment being carefully checked for weight and space requirements, and then reviewed from the standpoint of coordination of all parts for efficiency in battle.

Antenna problems

Locations of antennas must be studied from a stability and interference standpoint. Location of delicate parts must be arranged with respect to the location of heavy guns; special shock mountings must be provided in some cases, and cabling must be laid out in such a way as to gain maximum protection against damage.

In these studies, the Bureau of Ships' experts in various scientific fields are consulted to insure accuracy and soundness in the decisions made. Finally, when the installation plan is completed, it is sent to the building shipyards and

Navy Yards. The installations on the first ships of a new class are carefully observed in order that desirable changes in the installation plan may be promptly made so that all subsequent ships will benefit by experience gained on the prototypes.

At this point, the installing activity takes charge. Each Navy Yard and Naval District has under its jurisdiction a group of technically trained officers and civilian employees who make the actual installation. In addition to these men, the Electronics Division guides the activities of a large group of electronic engineers who are employees of various manufacturers. These engineers are dispatched to all Naval activities to act in an advisory capacity concerning problems of installation and maintenance, principally on the equipment made by their employers. They have been and are continuing to be of great assistance in some of the more difficult installations.

Of necessity, the Navy must

maintain a large number of shore radio stations in order that contact may be maintained with the various units of the Fleet and with the central communication centers of the Navy and our Allies. In addition to the hundreds of radio stations located throughout the continental United States there have been established many stations in advanced areas. These stations facilitate our operations in the far reaches of the Pacific, and additional units must be established around the perimeter of operations as the fleet moves forward.

These stations range from simple installations to large and complicated systems, exceeding in size some of the largest commercial installations. Because of the unprecedented expansion of the Navy's air arm, it has been found necessary to establish hundreds of Navy air stations both for operation and training.

The electronic installations at these air stations represent the latest and the finest in radio and radar systems. They must be in continuous operation and are spread to the four corners of the globe. This shore activity alone is larger than the combined operations of those of all the commercial air fleets now existing in the majority of the allied countries. It might be pointed out that on December 7, 1941, the Japanese Navy failed to destroy our high-power station at Pearl Harbor. This error on their part will contribute to their ultimate defeat, since its subsequent operation was the link connecting the Pacific areas with Navy headquarters in Washington.

The Installation and Maintenance Branch of the Electronics Division is charged with the proper planning for the installation of electronic equipments in all Marine Corps amphibious vehicles. The Marine Corps, in connection with the Navy, maintains and operates numerous advance base radio stations and control centers. It might also be pointed out that thousands of walkie-talkie sets and similar equipments are used by the Marine Corps. An interesting sidelight on the use of the Marine Corps equipment is that it is required to operate many times partially or completely submerged in water and under conditions which would make the average radio equipment fail in less than an hour's time.

The Marine Corps, in cooperation with the Installation and Maintenance Branch of the Electronics Division, is charged with the installation and maintenance of all communication equipment used in the continental United States and points abroad for maintaining internal security, and with the in-

stallation and maintenance of all communication equipment used between shore patrols and military police jeeps in their respective headquarters.

Field service

In addition, the Electronics Division has recruited and trained a "flying squadron" of carefully trained Navy technicians organized as the "Electronic Field Service Group." These technicians are assigned primarily to absorb the impact of new programs or projects which would place too great a load on the normal facilities of the Navy Yards and other installing agencies, and to handle other emergency work. A picked group of these technicians travel with the fleet wherever it goes, transferring from ship to ship as the exigencies of the current situation demand. These men are trained in the installation and maintenance of the latest type equipments and are therefore able to render prompt and able assistance to ship forces in solving their problems.

The function of the Electronics Division in the maintenance of fleet electronic equipment involves four major activities:

(1) The direction of normal day-to-day maintenance by technicians aboard ship. Analysis of thousands of trouble reports each month gives a clew to types of preventive maintenance which will insure dependable operation at all times. Main-

tenance Bulletins containing valuable information on preventive maintenance and trouble-shooting are prepared by the Division's engineers and distributed to all naval activities frequently.

(2) Liaison with all schools engaged in training naval personnel in the installation and maintenance of electronic equipment used throughout the Navy. This liaison work includes advising training schools on the technical aspects of their curricula and supplying them with adequate amounts of the latest equipment.

(3) Assisting repair facilities such as Navy Yards as required in the emergency work of repairing or replacing battle damaged equipment.

(4) Many additional publications dealing with special installation and maintenance problems are prepared by the Electronics Division's engineers aimed at improving the performance of radio, radar, and sonar equipment to the end that the fleet and naval establishment will have available, at all times, dependable, up-to-the-minute electronic equipment to play its great part in defeating our enemies.

Thus the Electronics Division of the Bureau of Ships is performing its job of coordinating the efforts of approximately 75,000 workers who have already installed almost two billion dollars worth of electronic equipment, and who are performing efficiently in the maintenance of this vast amount of radio, radar, and sonar apparatus.

Another view of the Navy Electronic Exhibit showing shipboard radiotelephone, model 15 teletype receiver, Marine Corps invasion equipment lifeboat set and amphibious radiophone



TUBES ON THE JOB

Electronic Piston Ring Inspector

An electronic piston ring inspector has been designed by engineers of The Sheffield Corp., Dayton, to eliminate the human element in checking piston rings and thus attain a very high degree of accuracy. The instrument automatically inspects the trueness of periphery and the width of gap of a specific size of piston ring. The ring is inserted inside a master ring of correct dimensions which is placed on the instrument table and rotated by a power-driven roller. The gaging functions are performed by scanning beams of light directed onto photoelectric cells which energize electronic circuits to illuminate three signal lights.

As the ring revolves, one beam of light is projected on the periphery. A clearance between it and the master ring will result from any out-of-round condition of the piston ring, permitting part of the light beam to fall on the photoelectric cell. This cell is set to actuate a red rejection signal should an excessive amount of light indicate that the piston ring is out-of-round beyond an acceptable point.

Should the periphery be within tolerance limits, a green signal will

flash on at the end of one complete revolution provided the width of gap is also within tolerance, or a yellow signal will show if the gap is undersize. The beam of light is interrupted by a mechanical shutter arrangement at the time the gap is passing this point.

Another beam of light scans the width of gap, the photoelectric cell being set to actuate a yellow signal should the gap be undersize. A third beam of light energizes another photoelectric cell set to illuminate the red rejection signal should the width of gap be oversized.

Time saving

Master rings of known dimensional quality are used in adjusting the instrument for the desired tolerances. The instrument can be adapted to various nominal sizes, gaps of varying width, and also for variations on the allowable out-of-roundness of the periphery. Trueness of the periphery can be determined within a tolerance of .0001 in.

With this instrument, the inspection cycle per piece is less than 5 seconds, and the production rate is determined by the speed at which the rings are presented to the gage. In all cases, inspection will be much faster than can be accomplished by present hand-checking methods. Of more importance, the rings will be checked accurately and uniformly so that possibility of assembly troubles is greatly reduced—and the mechanism will give a far higher quality of performance for a much longer length of time.



50,000 Hours' Service From CR Tube

Engineers at Station WCAE, Pittsburgh, have hung up what is believed to be an all-time high in maintaining a cathode ray monitoring tube in continuous operation for more than 50,000 hours. The RCA type 904 cathode ray tube, used for monitoring radio programs, was installed in the station's transmitter in August, 1939, and is still providing the same clear monitoring picture it did five and a half years ago. James Schultz, WCAE's chief engineer, reports that the tube shows no perceptible depreciation in sensitivity or definition.

Electronic "Permanent" Frees Rayon Curls

A new electronic de-kinking process is being used to rid rayon cord of its tendency to curl, permitting its use in weftless form (without cross-woven cords) in the carcasses of heavy-duty truck tires. Spools of the rayon cord are put through an electronic oven where heat, applied "internally" by electrical agitation of the molecules, gives the rayon the opposite of a permanent wave, Bert S. Taylor, processing superintendent of the B. F. Goodrich Co., Akron, explains. Even though the spools of cord are covered with wax paper the new process does not affect the wax wrapping in any way.

Formerly rayon cord was not entirely suited for use in weftless fabric because of a kinking tendency. Now heavy-duty truck tires made by Goodrich are made of weftless fabric with the treated rayon cord.



The electronic piston ring inspector, depending for operation upon photoelectric tubes reduces inspection time per piece to five seconds, greatly improves accuracy

ASSOCIATION NEWS

Tube Standardization

Among other matters of routine business, Radio Manufacturers Association at its directors' meeting in New York late in February formally approved operation of the Joint Electronic Tube Engineering Council, a new agency jointly established by RMA and NEMA for the standardization of tubes. Without disturbing present standards, JETEC will handle future standardization of all tubes, transmitting, receiving, industrial and non-industrial.

The agency will have a policy committee consisting of Dr. W. R. G. Baker, director of the RMA engineering department, and president A. C. Streamer of NEMA. It will operate through the RMA Data Bureau, of which L. C. F. Horle is manager. There will be a JETEC engineering council, with four members, two each from RMA and NEMA, which will issue tube standards after approval by the respective RMA and NEMA general standards committees. The four members of the Council are: O. W. Pike, General Electric Co., chairman; J. R. Steen, Sylvania Electric Products Inc.; A. Senauke, Ampere Electronic Corp., and D. D. Knowles, Westinghouse Electric & Mfg. Co.

Sound Film Standards

A group of three standards to assure high fidelity in the sound reproduction of 16 mm motion picture films has just been completed by the American Standards Association. This work has been done at the request of the Armed Forces to assist them in obtaining satis-

factory 16 mm prints for the training films now used so extensively in all branches of the Services and for the entertainment films used widely overseas. The three new standards constitute part of the work done by the War Committee on Photography and Cinematography of the American Standards Association.

RMA Adds Ten

With the admission of ten new members to Radio Manufacturers Association, that organization's membership has hit its highest point since 1929. Total membership is now 236. New members added to the roster are: American Coil & Engineering Co., Chicago; Chicago Condenser Corp., Chicago; Electrical Reactance Corp., Franklinville, N. Y.; Jackson Industries, Chicago; Measurements Corp., Boonton, N. J.; Minerva Corp. of America, New York; J. P. Seeburg Corp., Chicago; Sherron Electronics Co., Brooklyn, N. Y.; U. S. Television Mfg. Co., New York; Zell Co., New York.

NAB Adds 31

Swelling the total to 654, thirty-one more broadcasting stations were admitted to its roster during the past three months by the National Association of Broadcasters. Of these, 635 are AM stations. Frequency modulation, television, and networks round out the total of 654, with 37 associates representing equipment manufacturers, station representatives, transcription companies and market research organizations.

West Coast Electronic Manufacturers Executive Council



The newly elected executive council of the West Coast Electronic Manufacturers' Association at its San Francisco meeting includes: First row—H. L. Hoffman (Hoffman Radio Corp.); J. G. Copeland (Linton Engineering); Howard Thomas; Clayton F. Bane; James L. Fouch (Universal Microphone); Herb Becker (Eitel-McCullough); and Wallace Wahlgreen (Specialty Division, Gardner Electric). Back row—Ash Wood (Littelfuse, Inc.); R. C. Shermund (Industrial and Communications Electronics); Mason Shaw (Lewls Electronics); Dave Marcus (Electronic Specialty Co.); Frank Fisher (Radiation Products, Inc.); E. G. Danielson (Remler Corp.) and Lew Howard (Peerless Electrical Products Co.).

Instrumentation Exhibit

The Instrumentation Exhibit originally scheduled by the American Society for Measurement and Control for Pittsburgh during the week of Sept. 17-21, is still on the cards. There remains some question, though, whether the war will be over in time to permit going ahead. In the meantime prospective exhibitors are being urged to complete arrangements for the affair. Paul B. Exline is chairman of the exhibit committee and his address is P. O. Drawer 2038, Pittsburgh 30, Pa.

Conventions and Meetings Ahead

Electrochemical Society (Colin G. Fink, Columbia University, New York); Spring Convention, April 12-14, Hotel Claridge, Atlantic City.

Optical Society of America (A. C. Hardy, Massachusetts Institute of Technology); April 12-14, Cleveland, Ohio.

American Society of Mechanical Engineers, (Ernest Hartford, 29 W. 39th St., New York); April 16-18, Boston; June 18-21, Chicago.

American Mathematical Society (531 W. 116th St., New York); April 27-28, New York, Chicago, Stanford University, Cal.

Society of Motion Picture Engineers (J. Haber, Hotel Pennsylvania, New York); May 14-18, Hollywood-Roosevelt Hotel, Hollywood, Cal.

Society for Experimental Stress Analysis (W. M. Murray, President, Central Square Station, Cambridge 39, Mass., Post Office Box 168); 1945 Spring Meeting, May, Buffalo, N. Y.

American Society for Testing Materials (260 S. Broad Street, Philadelphia, Pa.), June 18-22, Buffalo, N. Y.

American Society for Measurement and Control (L. Susany, c/o Carnegie Institute, 4400 Forbes Street, Pittsburgh); "Instrumentation for Tomorrow" Exhibit and Conference, September 17-21, William Penn Hotel, Pittsburgh.

In conformity with government regulations, many organizations have cancelled scheduled gatherings; others have requested permission to go ahead but have not had definite instructions. In view of these facts it would be well for those who contemplate attending meetings to check first with the organization before arranging transportation.

SURVEY of WIDE READING

Electronic news in the world's press. Review of engineering, scientific and industrial journals, here and abroad

Circle Diagram in Impedance Matching

A. H. Wing and J. Eisenstein (Journal of Applied Physics, August, 1944)

It is possible to match any symmetrical antenna or two-terminal impedance to a loss-less transmission line feeder by means of a single open or closed stub of suitable length placed on the transmission line at the proper point (Fig. 1).

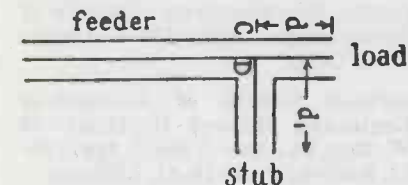
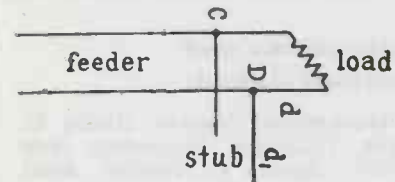

Fig. 1. Single-stub matching

As is well known, the stub is located at CD, where the admittance looking toward the load has a conductance equal to the characteristic conductance of the line; the per unit conductance at CD will then be equal to unity. The stub is added in parallel and its length d_1 and termination (closed or open) are chosen so that its susceptance is of equal magnitude but of opposite sign to the susceptance at CD looking toward the load; the total susceptance of the terminated line d plus stub will then be zero. The two lengths d and d_1 can be found from the equations:

$$\cot \beta d_1 = \left[\frac{(1 - g_R)^2 + b_R^2}{g_R} \right]^{1/2}$$

$$\tan \beta d = \frac{1 - g_R}{g_R \cot \beta d_1 - b_R}$$

} Closed stub

$$\tan \beta d_1 = \left[\frac{(g_R - 1)^2 + b_R^2}{g_R} \right]^{1/2}$$

$$\tan \beta d = \frac{g_R - 1}{g_R \tan \beta d_1 + b_R}$$

} Open stub

where

$$\beta = 2\pi/\lambda$$

and g_R and b_R are the ratio of the load conductance to the characteristic conductance of the line and of the load susceptance to the characteristic conductance of the line, respectively; these ratios are termed the per unit conductance and the per unit susceptance.

Double-stub matching

It is not always convenient to provide an adjustment in the position of the stub, and an open stub may not be lengthened easily. To overcome these difficulties, two closed stubs of adjustable lengths d_1 , d_2 , but of fixed position, may be used (Fig. 2). The formulas giving (Continued on page 164)

Effect of Oxygen on Secondary Emission

R. Suhrmann and W. Kundt (Zeitschrift fuer Physik, Berlin, Vol. 121, Nos. 1 and 2).

Thin copper, silver, gold, cadmium, and beryllium layers are condensed onto a glass surface in high vacuum and exposed to the influence of oxygen at room temperature; the oxygen will either be adsorbed by the metal layers or will oxidize them. Then vacuum is restored and the secondary emission coefficient, i.e., the ratio of the secondary electron current to the primary electron current, is determined (Continued on page 168)

Fig. 3. Circle diagram adapted for graphical determination of the lengths of two matching stubs if characteristic resistance of line and impedance of terminating load are known

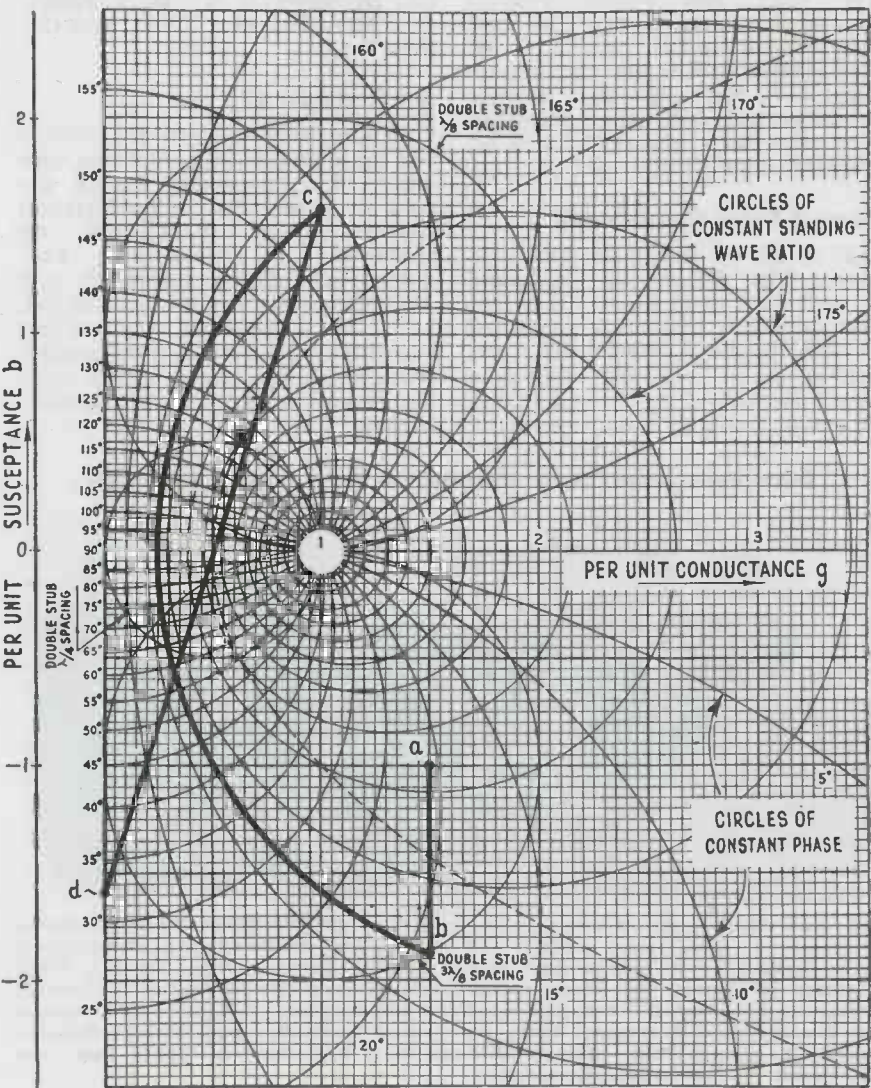

Again it's **HYTRON**—Easy on the Battery!



HY1269



HY31Z



HY65



HY69



HY1231Z

In mobile operation, the battery is the kingpin. Two-way police radio takes it out of the battery twenty-four hours a day. Conservation of battery power during stand-by periods is mandatory.

Instant-heating Hytron tubes with thoriated tungsten filaments came to the rescue of police radio. Only when on duty, does police radio equipment draw power when Hytron tubes are used. Filament and plate power go on together.

And that's not all. The Hytron HY31Z, HY65, HY69, HY1231Z, and HY1269 are rugged. HY65 performance in two-way

motorcycle police radio has proved this. Including 12-volt filament tubes for marine applications, Hytron's instant-heating line is versatile. Concentration is on the R. F. beam tetrode — work horse of transmitting tubes — but also included is the HY31Z twin triode for Class B. One type can power a whole transmitter — R. F. and A. F. — thus simplifying the spares problem (e.g., Kaar Engineering transmitters built around the HY69).

Wartime uses are bringing additions to the Hytron instant-heating line. Watch for future announcements.

OLDEST EXCLUSIVE MANUFACTURER OF RADIO RECEIVING TUBES

HYTRON
RADIO AND ELECTRONICS CORP.

MAIN OFFICE: SALEM, MASSACHUSETTS
PLANTS: SALEM, NEWBURYPORT, BEVERLY & LAWRENCE



FORMERLY HYTRON CORPORATION

WHAT'S NEW

Devices, products and materials the manufacturers offer

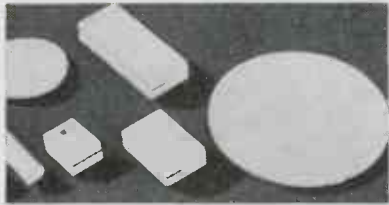

Ceramic Capacitor Dielectric

The Mycalex Corp., Clifton, N. J., has developed a new grade of Mycalex insulation (Series K) as a capacitor dielectric. Mycalex K offers a selective range of dielectric constants, from 8 to 15 at one megacycle. It is available in thickness of $\frac{1}{8}$ to 1 in., in 14 x 18 in. sheets; thickness down to $\frac{1}{32}$ in. in smaller sheets, and 14 to 18 in. rods, $\frac{1}{4}$ to 1 in. in diameter.

Vacuum Capacitor

A new vacuum capacitor has been developed by Industrial and Commercial Electronics, Belmont, Calif. Units are available with capacities ranging from 10 to 110 mmfds. in steps of one mmfd., accurate within one mmfd. plus or minus. A special grade is also available having tolerances held to tenths of one mmfd.

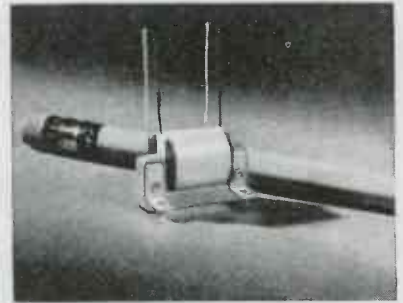

Midget Transformer

A new transformer, 31/32 x 37/64 x 7/16 in., small enough to be incorporated directly into the cases of earphones and hand-held microphones, has been developed by Permoflux Corp., 4900 W. Grand Ave., Chicago. A new design, combined with newly developed materials and manufacturing methods, results in an 80 per cent to 90 per cent operating efficiency with a uniform frequency response to ± 2 db from 100 to 8,000 cycles. These transformers can be made with windings to provide impedances as high as 200,000 ohms and, when used as a choke coil, with inductive reactance as high as one megohm. They may be potted, shielded or hermetically sealed if desired.



Outdoor Horn

The 24-A loudspeaker, a product of the Langevin Co., 37 W. 65th Street, New York, is designed for outdoor applications, is weatherproof and has a new type non-corrosive vitreous finish. The horn is of exponential form so that the off-axis levels follow the usual curves. The bell diameter is 25 in., over-all length 38 in., over-all width 26 in., frequency response 110 to 6500 cps. Receiver attachments are available for coupling two or four driver units and making the horn capable of maximum inputs of 50 and 100 watts.



Induction Heater

A new electronic induction heater for brazing, soldering, annealing, hardening and pre-Forge heating applications has been developed by the Allis-Chalmers Mfg. Co., Milwaukee, Wis. With a low-loss coupling arrangement, the new generator can be adapted to a wide variety of metal-working applications without the use of radio-frequency transformers. Predetermined automatic timing controls each unit operation. Other features include a current limiting circuit for protecting the oscillator filament and prolonging tube life; a three-phase rectifier on larger size units. All models having a capacity of 10 or more kw operate from either 220 or 440 volts, three phase supply.



Transmitting Tube Socket

A special transmitting tube socket (No. 244) of low loss steatite construction is being produced by the E. F. Johnson Co., Waseca, Minn. It accommodates the new jumbo 4-prong bases of 8008, BR6, GL146, SC22, GL152, GL159 and GL169 tubes, measures 2 1/2 x 2 1/2 in. by 3/4 in. thick. One piece base construction has molded in bosses on top, the bosses being ground to present a flat mounting surface underneath a chassis. Cadmium plated brass contacts with steel spring reinforcements are riveted to the ceramic base in such a way that they can not turn.

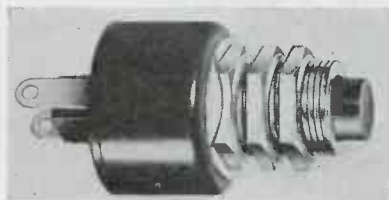

Snap Action Switch

A small momentary push-button, snap-action switch developed by Grayhill, 1 North Pulaski Road, Chicago. The phenolic body of the switch is round and measures 3/8 in. in diameter by 1 1/2 in. high. The fixed contacts are silver overlay on phosphor bronze, threaded and held securely in place, the electrical connection being made by brass screws which also hold and secure the two solder lugs. The moving contact which bridges the two fixed contacts is also silver overlay on phosphor bronze. The contact gap is .040 in. on each contact; therefore, the total contact gap which breaks the circuit is .080 in. The switch operates on a .0625 in. movement of the push button and carries a current rating of 10 amperes at 115 volts ac, and 2 amperes at 115 volts dc.



Regulated Power Supply

A new self-contained regulated power supply (Type PS-5) has been developed by the Specialty Division of the General Electric Electronics Department, Schenectady, N. Y. It will hold dc output voltage constant at any selected value, within the range of 160 to 1500 volts, regardless of moderately large or rapid changes in the load current. The unit has a low internal ac impedance which makes it especially useful as a power supply for devices which require the practical elimination of the common coupling ordinarily encountered in power supplies.

Molding Compound

Durez Plastics & Chemicals, Inc., No. Tonawanda, N. Y., has developed a mineral-filled phenolic molding compound (Durez 12708 natural) adaptable for use in parts which require metal inserts. It has been especially compounded for use where temperature variations occur frequently and has a low shrinkage factor.



UHF HARMONIC FREQUENCY GENERATOR

PROVIDES output voltages in 10 or 40 megacycles with CRYSTAL-CONTROLLED accuracy.

SELECTS 10 or 40 megacycle series and IDENTIFIES any one of these harmonics by means of a Frequency Identifier* which consists of a filter providing high attenuation of all voltages except that of frequency to be identified.

USED FOR calibration of receivers, wavemeters, or (with Beat Detector supplied separately) for calibration of oscillators and signal generators.

UHF PRECISION FREQUENCY METER

Completely portable Accuracy 0.1%
Battery or AC-Operated

Models available from 100 to 1500 megacycles with 2 to 1 frequency coverage on each model. Available only on high priority.

RECOMMENDED FOR:

- Production testing
- Measurement of oscillator drift
- Independent alignment of transmitters and receivers
- Precise measurements of frequencies

PRECISION . . . IN MANUFACTURE AND PERFORMANCE!

The LAVOIE trademark is your guarantee of exacting manufacture and precision performance. From the outset we have specialized in the development and production of UHF equipment, working to standards of absolute precision in design, manufacture and operation. The UHF HARMONIC FREQUENCY GENERATOR and PRECISION FREQUENCY METER, shown here, are indicative of the scope of our work and specialized background. We shall be glad to send you additional information on these instruments or discuss any specific requirements you may have in the UHF field for the present or post-war uses.

* Specify frequency of Identifier wanted.

Lavoie Laboratories

RADIO ENGINEERS AND MANUFACTURERS

MORGANVILLE, N. J.

**Specialists in The Development of UHF Equipment
and in The Manufacture of UHF Antennas**

Power Resistors

The new IRC Type GRW power wire wound resistor has greater mechanical strength and a much higher safety factor. It is a completely sealed unit and passes all JAN-R-26 tests. All connections are welded, and the pyrex glass enclosure tube is heat-treated. Sealing between the ferules and the pyrex glass enclosure is pure lead. Seven standard sizes are available. They correspond to Army-Navy Types RW-10F to RW-16F, inclusive, and are identified as IRC Types GRW-10 to GRW-16. Resistance values covered are from 0.1 ohm to 46,000 ohms, with power ratings from 15 to 140 watts. Maker is International Resistance Co., Dept. N, 401 N. Broad St., Philadelphia 8, Pa.



Recording Vacuum Gages

A new group of Televac recording instruments has just been developed by Precision Scientific Co., 1750 N. Springfield Avenue, Chicago. Type MR instrument with a range of 0-500 microns utilizes the new Televac \$500 Thermal Gauge with specially treated elements. Features include coated filaments to prevent "off calibration" periods due to water, oil vapor or other contaminating vapors, increased sensitivity gained through use of two filaments in both standard and variable tubes of the vacuum gage; all gages are interchangeable without recalibration, and the user is assured of duplicate readings in terms of absolute pressure in microns. The gage is supplied with a special Leeds and Northrup Micromax strip chart recorder calibrated directly in microns. Type "S" recorder for ultra vacuum contains two ranges—0-500 microns for pressures above 1 micron, and utilizing the \$500 thermal gage in this range and an industrial type ionization gage for the range 0 to 0.4 microns. Accurate readings may be obtained down to 10^{-8} mm Hg. (.001 micron). The type "S" instrument also features a safety circuit which makes it impossible to turn on the ionization gage until a vacuum of 1 micron has been reached. Average life of ionization gage is 3,000 hours.



Power Level Meter

The Weston Model 695 Type 11 portable test instrument is essentially a rectifier type voltmeter which provides readings in decibels as well as in volts and ac voltage measurements from 2 to 200 volts full scale. A medium speed instrument with moderately damped movement, Model 695 has a constant impedance of 20,000 ohms. When connected across any sound line, ranges can be shifted continually without varying line impedance. Eleven db ranges are provided, from -4 to +36 db at zero on the db scale. Seven ac ranges from 2 to 200 volts also are available. A self-contained capacitor, available through a separate pinjack, is provided for blocking dc component. The instrument is calibrated for 500 ohm lines with a zero level of 6 milliwatts or 1.732 volts. Each instrument is supplied with a chart giving interpolation values on lines other than 500 ohms (from 5 to 10,000 ohms at 6 milliwatts zero level). Maker is Weston Electrical Instrument Corp., 617 Frelinghuysen Avenue, Newark, N. J.

Keying Relay

Originally designed for aircraft use, the new Struthers-Dunn Type 78CCA100 vacuum switch keying relay has seven poles, including one double-throw pole which handles high-voltage radio-frequency currents by means of a vacuum switch. All high-voltage parts are rounded to reduce corona. Maker is Struthers-Dunn, Inc., 1321 Arch St., Philadelphia 7, Pa.

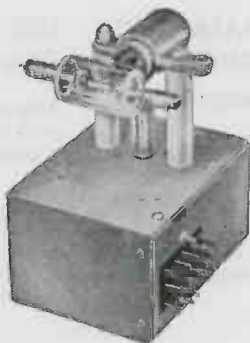

Light Weight Blower

A new light weight blower for heat dispersion (Model No. 2 1/2) has been added to the line of the L. R. Mfg. Co., division of The Ripley Co., Torrington, Conn. The one piece housing with aluminum motor plate is 4 1/2 in. from top to bottom, weighs 3 1/2 oz. and delivers 50 CFM at 8,000 rpm. It is available with shaft bores of either .1895 in. or 1/4 in.

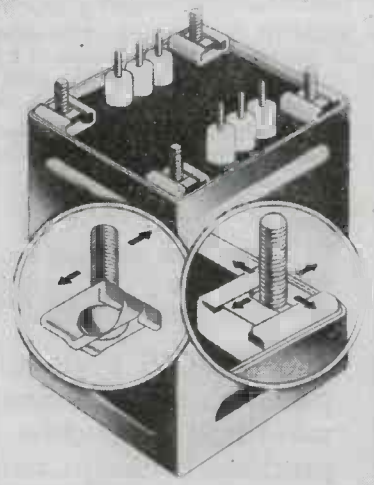

Metal Brake

The Di-Aero radius brake is a precision machine capable of properly forming duraluminum, chrome molybdenum, rust resistant and spring tempered alloys, and various other low ductile materials without the possibility of fracture or disintegration developing at the line of forming. The radii obtainable are 1/16, 3/32, 1/8, 5/32 and 3/16 inches, folding width being 12 in. Case hardened and spring tempered materials that must be formed after heat treating can be worked to accurate dimensions. The maker is O'Neil-Irwin Mfg. Co., Minneapolis.



Self-Aligning Transformer

A new development in transformers with self-aligning, detachable mounting studs is now in production by the Electronic Components Company, 423 N. Western Avenue, Los Angeles. This feature allows an actual tolerance in mounting dimensions that can exceed one-quarter inch and eliminates rejects due to bad threads, leaks around studs, bent or broken studs or changes in length specifications. A simple clip arrangement, stamped from heavy gage steel, cadmium plated, prevents the stud from turning while it permits centering in two directions. The stud can be moved in four directions to align with irregularly spaced holes and is replaceable in the field with any round head machine screw available. Transformers equipped with this new Ecco mounting feature are available in 15 standard case sizes, either hermetically or non-hermetically sealed.

For the "Newspaper of the Air"



SELF SYNCHRONIZING

finch facsimile

DELIVERS PICTURES AND TEXT BY RADIO OR WIRE

FINCH TELECOMMUNICATIONS, INC. • PASSAIC, N. J.

WASHINGTON

Latest Electronic News Developments Summarized
by Electronic Industries' Washington Bureau

GOAL OF ORDERLY RECONVERSION—Until the European fighting has been terminated, it has been both impossible and impracticable for the Army Signal Corps to announce to the radio-electronic manufacturing industry its requirements for the remainder of 1945. But it must be noted that the industry's plants have been called upon during the first half of this year to produce the largest amount of equipment and components for the Army and our Allies ever before scheduled in its history and during the war. The Signal Corps procurement staff under the leadership of Major General William H. Harrison is striving to achieve as orderly transition from a war to peacetime economy as possible and its scheduling after V-E Day is to be accomplished with cutbacks by degrees.

STOCKPILES NOT EXCESSIVE—The Signal Corps has been closely controlling its requirements so that by and large its stockpiles and reserve supplies are in excellent shape and not excessive. To illustrate its goal of an orderly reconversion, the Signal Corps' placement of orders during the past two years has had little swing, not more than 15 per cent either way, and this process will be the program of the future.

FROM FACTORY TO FRONT LINE TROOPS—During the repulse of the Nazi offensive and now the onslaught into Germany, radio-electronic production has been mainly replacements of equipment and of parts and a substantial share of critical types of apparatus and components were rushed directly from the factory to the combat troops in the front lines; in some cases certain highly important sets were even flown from the United States to the Army units. This was an unusual procedure and now the Signal Corps has been engaged in establishing reserves of equipment in the supply depots back of the front line divisions.

SPECTRUM DETERMINATION—The FCC is slated to determine its final Allocation Plan early in May and every advance indication was that it would adhere to its original proposal of moving FM broadcasting "upstairs" from its present 42-50 mc band to 84-102 mc. Television is to retain its previously proposed spectrum space without any additional assignments as sought by the Television Broadcasters Association and DuMont spokesmen in the early March oral arguments. The enlargement of the television allocations to take in all the space from 44 to 216 megacycles intrigued the FCC, but was regarded generally as too big a bite for the video industry.

CLASSIFIED PROPAGATION DATA—Most interesting phase of the FCC's last lap in analyzing the postwar allocations came behind closed doors and cloaked with military secrecy, when on March 12 Army and Navy radio experts disclosed to the Commission and leading industry engineers, headed by Major Armstrong, FM inventor, the classified propagation data on bursts and multipath shadows on which former FCC Engineer K. A. Norton had based his opinions for the upward move of FM broadcasting. Later, it

is believed the Joint Army-Navy Chiefs of Staff may release the technical studies on which the secret propagation data is based.

LITTLE CHANGE IN PATENT OFFICE POLICIES—The new Secretary of Commerce Henry Wallace under whose Department falls the Patent Office is not expected to overturn the present patent policies and procedure with the injection of some of the New Deal patent philosophies for the time being at least and probably not until the end of the war. Patents Commissioner Coe who is highly regarded for his knowledge of the patent situation is a Presidential appointee and is felt to be certain to remain at the helm of the Patent Office; the only major possible change is that Secretary Wallace may recommend to the President an enlargement of the National Patent Planning Commission, headed by Dr. Charles F. Kettering. General speculation, too, is that other than the generally accepted ideas of revamping the patent statutes to prevent potential abuses of patent rights there will be no request for Congressional amendment of the Patent Laws—in other words, there is little likelihood of such drastic proposals as compulsory licensing, etc.

ARMY AIR FORCES TAKE OVER—The AAF's Office of Communications and the Technical Service Command, the latter headed in its radio-electronic phases by Major General Roger B. Colton, formerly of the Signal Corps, on April 1 took over from the Signal Corps all procurement and distribution of airborne radio, radar and electronic equipment. Since the first of the year, the Air Forces have directed all aircraft radio and radar development and research, having taken over the Signal Corps' Aircraft Radio Laboratory at Wright Field with its former commander, Col. Reed Yeager. In the case of procurement and distribution the entire Signal Corps units handling airborne radio-electronic equipment, which are almost entirely concentrated at Dayton, have been transferred to the AAF.

MISCELLANY—The war job of radio and electronics from July, 1940, to the end of 1944 has been disclosed—it amounted to \$4,459,000,000 for radio apparatus and \$2,827,000,000 for electronic equipment. . . . OPA is presenting radio set and tube industries with new ceiling prices for civilian postwar sales during April. . . . All of the radio-electronic equipment on the European front after V-E Day which can be transferred to the Pacific theatre will be "tropicalized." . . . No immediate prospect of improved output of civilian home receiver replacement tube supply, although same quotas as in 1944, in sight because of military requirements, but is to be brightened with European victory. . . . WPB Radio and Radar Division is encouraging railroad radio experimentation. . . . Radio Technical Commission for Aeronautics established subcommittees for studies of postwar aviation radio equipment and system.

National Press Building
Washington, D. C.

ROLAND C. DAVIES
Washington Editor

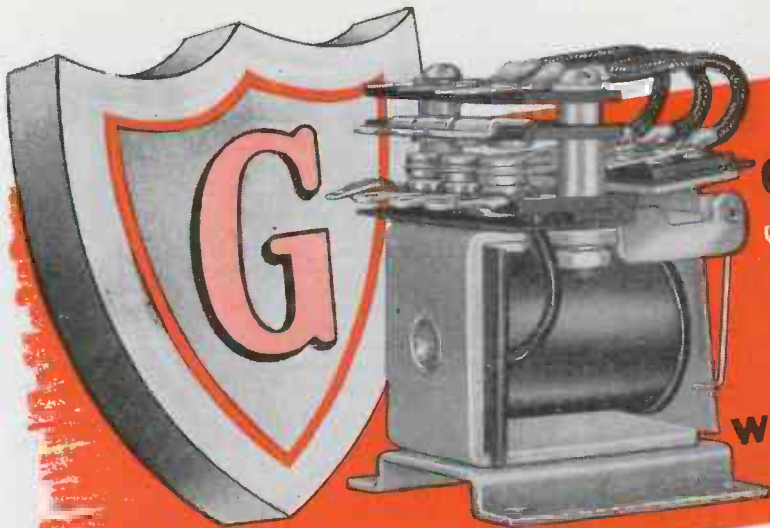

GUARDIAN Series 345 RELAY

a "Basic Design"
with many variations

meets special applications
saves time . . . saves tooling . . . speeds delivery!

If your application requires a specially designed relay Guardian engineers can be of great help to you. But, as a result of their wide experience in designing "specials" they have evolved a standard design so flexible that it is now specified in numerous applications that would ordinarily require a specially designed unit. Perhaps you can use it in your "special" application . . . with a saving in money and delivery time. This unusually flexible relay is the SERIES 345. Its chief features are the large coil winding area, numerous contact combinations, the non-binding pin type armature hinge pin, its resistance to shock and vibration, and an ability to operate in extremes of temperature. It is now being used in aircraft, radio, and other exact-

ing applications to insure dependable performance.
STANDARD SERIES 345—The ample coil winding area of the SERIES 345 gives you a wide range of windings for various voltages and currents. Coil winding area is approximately .75 cubic inches. Average power required is 3.56 watts with three pole, double throw contacts of 12½ amp. capacity. Coils are available for either A.C. or D.C. operation.
The maximum switch capacity of the Standard Series 345 is three pole, double throw. Contacts are rated at 12½ amperes at 110 volts, 60 cycles, non-inductive A.C. Moving contacts are attached to but insulated from the armature by a bakelite overlay plate. Terminals are solder lugs. Weight is 6½ ounces.

VARIATIONS OF THE SERIES 345 RELAY



TIME DELAY

WINDING—Multi-wound coils are available for operation on two or more circuits. Or coil may be wound to operate on the discharge of a 3 mfd. condenser.

CONTACTS—Normal switch capacity is three pole, double throw; maximum switch capacity may be up to six pole double throw with 12½ amp. contacts, or any vari-

ation of contact combinations within this range, including the operation of contacts in sequence. The flexibility of the contact springs may be increased through the use of coil spring rivets.

TIME DELAY—On D.C. coils a time delay of 0.25 seconds on release or 0.06 second on attract may be achieved through the use of copper slugs which require these time intervals for saturation or de-energizing depending on whether they are used on the heel or head of the coil.

DUST COVER—For applications where this relay may be subject to injury or in atmosphere where dust may be present in sufficient quantity to impede operation, the SERIES 345 may be equipped with a metal dustproof cover.

SCREW TERMINALS—Screw type terminals are optional for applications where terminals must be disconnected occa-

sionally or where solder lug terminals are not otherwise practical.

INTERLOCKING: Here the series 340 a-c relay is coupled with the d-c coil of a series 405 short telephone type relay in an overload application. Under normal conditions the series 340 contacts are mechanically held in a closed position. Normal

current flows through the series 405 coil and then through the series 340 contacts to the circuit for which overload protection is desired. Excessive current, however, energizes the series 405 coil, releasing the locking arrangement and breaking the series 340 contacts. Push button control resets to normal but is ineffective if current is still excessive.



DUST COVER

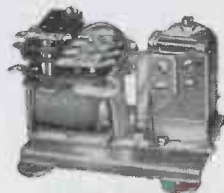

INTERLOCKING UNIT

SERIES 345 RELAY DATA

Normal Volts	Minimum Volts	Normal M.A.	Minimum M.A.	Coil Resist.	Normal Wattage
6	4.8	600	480	10	3.56
12	9.8	300	245	40	3.56
24	18	148	111	162	3.56
32	25.6	112	89	287	3.56
115	92	31	25	3720	3.56

Minimum operating wattage.....2.3

If you will write us about your relay problems our engineers will be glad to make recommendations which may save you time and money. Should you desire a quotation, please mention quantity.

GUARDIAN ELECTRIC

1622-D W. WALNUT STREET CHICAGO 12, ILLINOIS

A COMPLETE LINE OF RELAYS SERVING AMERICAN WAR INDUSTRY

NEW PATENTS ISSUED

FM-Pulse Transmission

A frequency-modulated carrier is keyed on and off at regular intervals so that short, frequency-modulated pulses are transmitted. The pulse frequency must be substantially above the highest modulation frequency; for instance the pulses may last 5 microseconds and be spaced 50 microseconds from one another. The receiver is designed to be inoperative during the time intervals when no pulses arrive, i.e., for about 45 microseconds out of each 50 microsecond period in the above example. (See figure.)

In such a system, the transmitted peak power can be increased without exceeding the normal dissipation rating of the tubes which are permitted to cool off when no pulses are sent. In the example given, the peak power may be increased by a factor of ten. At the receiver, the signal to noise ratio is increased as there is no reception at all when no pulses are received.

To provide the frequency-modulated pulses, a stabilized, wide-band, frequency-modulation transmitter is provided with a pulse keyer regularly to interrupt transmission. This pulse keyer consists of a square-wave generator, a rectifier and two limiter tubes; its output is applied to frequency-multipliers and/or subsequent amplifiers to cut-off the plate current for regularly recurring time intervals.

For reception of this type wave, an additional pulse generator unit is added to a conventional frequency-modulation receiver. (See figure.) It provides voltage pulses, in synchronism with the received frequency-modulated carrier pulses. These voltage pulses control the intermediate frequency amplifier and the limiter stages to be operative during the arrival of each pulse but completely inoperative in the time interval between pulses so as to prevent noise reception during that period.

B. Trevor, RCA, (F) December 24, 1940, (I) October 31, 1944, No. 2,361,437.

Transmitter Keyed Pulses

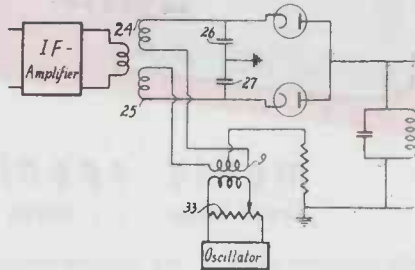
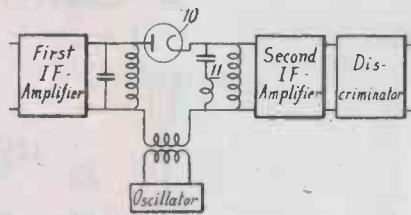
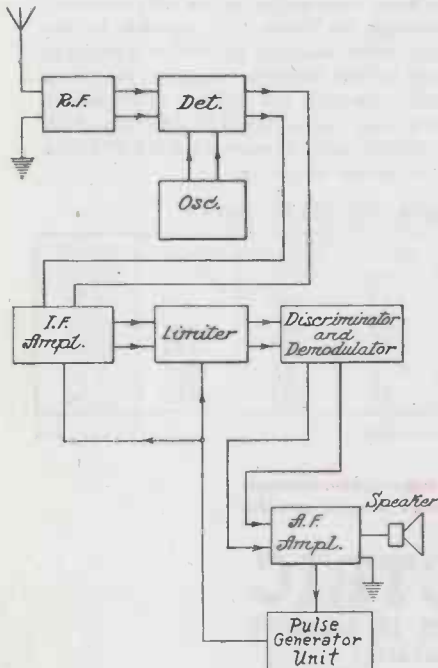
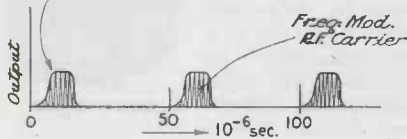

Limiter Circuit

To limit the amplitude of a frequency or phase modulated intermediate frequency wave, the wave is heterodyned in linear rectifier 10 with a locally generated oscillation of constant frequency and constant amplitude smaller than the smallest amplitude of the intermediate frequency signal. It is proved that under these circumstances the voltage amplitude of the difference frequency developed across tuned circuit 11 is determined by the amplitude of the local oscillation and hardly influenced by the amplitude of the intermediate frequency oscillation. The locally generated oscillation having constant amplitude, the difference frequency developed across resonant circuit 11 will also have constant amplitude.

A balanced heterodyning stage is provided in the other embodiment shown to minimize passage of signals of the first intermediate frequency to the demodulator. Capacitors 26,27 tune inductances 24,9,25 to resonance at the first intermediate frequency. The output voltage of the limiter can be regulated by adjustment of tap 33.

In a further modification of the circuit, the tuned circuit 11 and the following second intermediate frequency amplifier are omitted, and the output of rectifier 10 is directly applied to the discriminator.

D. A. Bell, Radio Patents Corp., (F) February 4, 1942, (I) November 21, 1944, No. 2,363,288.

Remote Control with Polarized Waves

The polarizing characteristics of electromagnetic waves such as the degree of ellipticity, or direction of polarization of plane polarized waves are used for remote control to synchronously rotate relays, switches, or motors.

In the example shown, plane-polarized, radio-frequency waves are emitted by the rotably mounted antenna, rotation of which in a vertical plane will change the direction of polarization. The receiving apparatus comprises two antennas mounted rotatably and at right angles to one another; they will be energized an amount depending on the angle between their direction and the direction of polarization of the received waves. Consequently, for the direction of polarization indicated by the arrow in the diagram, both antennas will have the same output and the relay will remain open as shown. However, if one of the antennas has a larger output than the other—as a result of a rotation of the transmitting

antenna—the relay will close and cause the motor to rotate both antennas in such a direction as to establish equal reception. It will be seen that the motor may be used to rotate any desired apparatus (100) in synchronism with rotation of the transmitting antenna. The transmitting antenna may be controlled manually as indicated or by any other desired means.

Similar apparatus using plane or elliptically polarized light, analyzers, and photocells are described but not claimed.

E. H. Land, Polaroid Corp., (F) September 16, 1940, (I) November 14, 1944, No. 2,362,832.

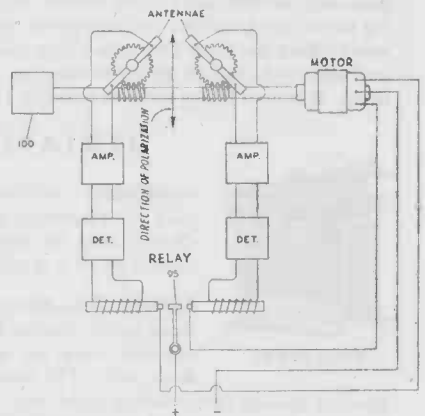
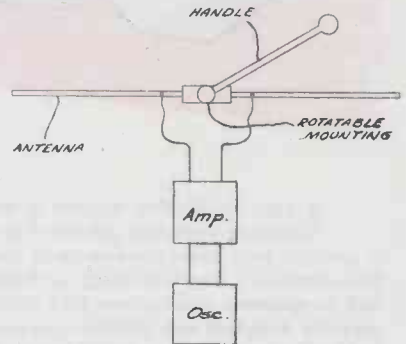

FM-System

During tests on the comparison of amplitude modulation with wide and narrow band systems of frequency modulation, it has been observed that with no modulation noise levels are very low on both of the frequency modulation systems compared with the amplitude modulation system. However, noise arose with modulation on the frequency modulation systems, whereas it stayed essentially constant on the amplitude modulation system. The result, as measured by a distortion meter, is that for full level modulation, less noise is present on the amplitude modulation system than on either the wide band or narrow band frequency modulation systems.

The noise-to-signal ratio increase when the wave is swung off carrier is, it is believed, due in part at least to the rounding off of the amplitude vs. frequency characteristic of the selective circuits. The noise rise observed is also due in part to the improper cancellation of noise when the incoming wave deviates from the carrier frequency to which the discriminator is tuned.

To cure this defect it is proposed to increase the amplitude of the frequency modulated wave with increasing deviation from the carrier frequency. The system involves a combined frequency-amplitude modulation of the carrier wave.

(Continued on page 186)

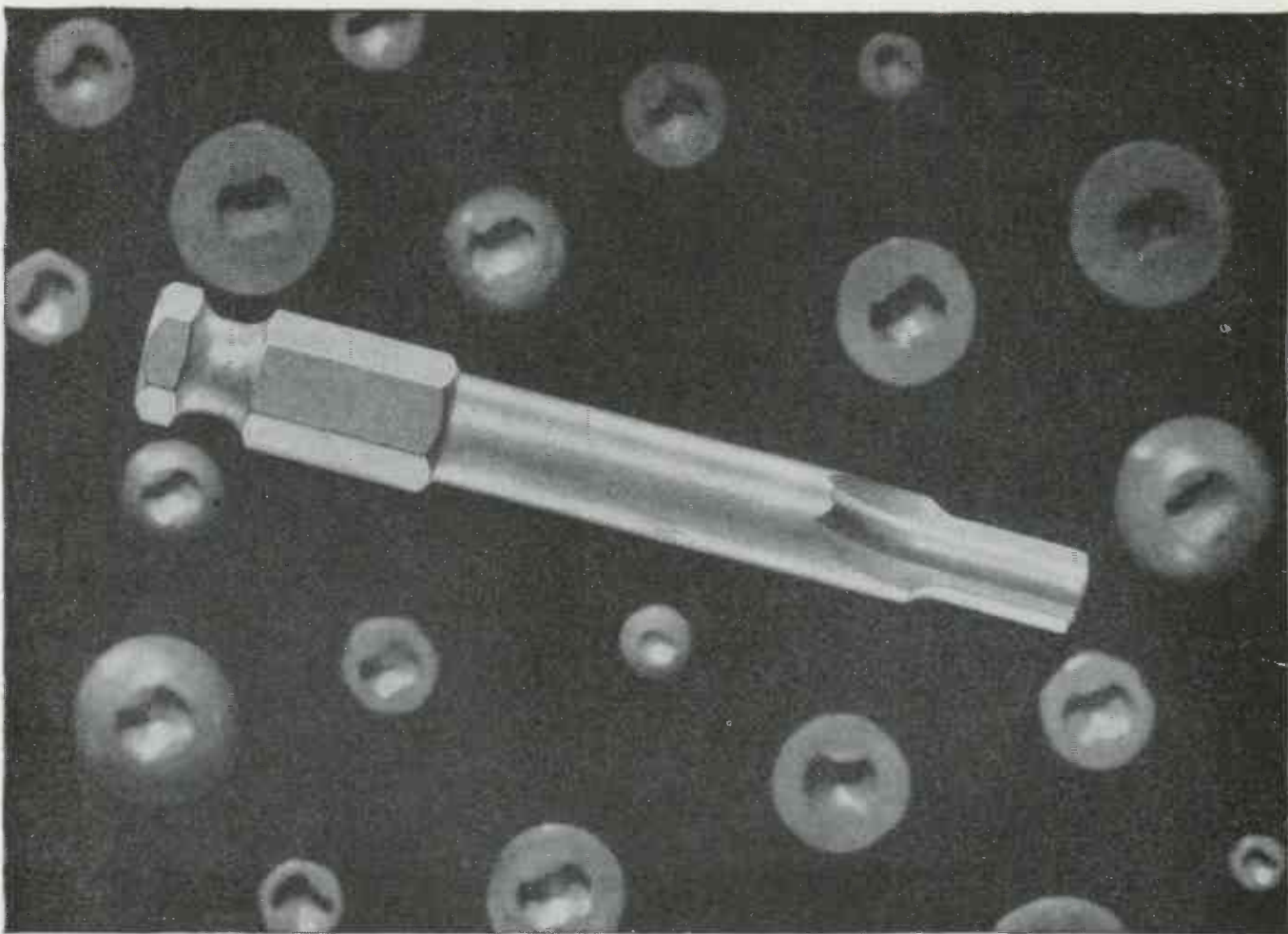

How Many Thousands of Screws Per Bit?

CLUTCH HEAD users have the answer to this question . . . for that is how they measure the economy and efficiency of screw driving on their assembly lines.

The explanation of this unequalled "high-score" driving is simple. It lies in the ruggedness and design of the Type "A" Bit. This ruggedness is self-evident and is made possible ONLY by the mating design of the Clutch recess. This means stamina . . . stand up through a longer driving spell, free from tool change interruptions . . . speeding up the production tempo and rolling up the record of thousand upon thousand of extra screws per bit.

Note, too, that the driving score of this bit is multiplied time and time again because it may be repeatedly restored to original efficiency by a 60-second application of the end surface to a grinding wheel.

Other special features incorporated in CLUTCH HEAD Screws contribute importantly to greater safety, higher production, and lower costs. We invite your personal investigation of these and will send you, BY MAIL, package assortment of CLUTCH HEAD Screws, sample Type "A" Bit, and illustrated Brochure.

Being operative with an ordinary screwdriver or any flat blade of reasonably accurate width, this is THE ONLY MODERN SCREW that simplifies your field service problems.

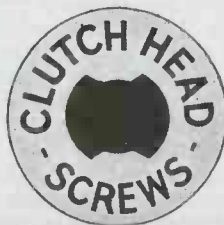

Note the straight-walled Clutch matched by straight-sided driver for square engagement, eliminating "ride-out" tendency with hazard of slippage as set up by tapered driving.



UNITED SCREW AND BOLT CORPORATION
CHICAGO 8 CLEVELAND 2 NEW YORK 7

★ TELEVISION TODAY* ★

New Developments in the Video Field

TBA Engineering Group

Television Broadcasters Association has appointed the following to a TBA engineering committee: W. J. Purcell, General Electric Co., Schenectady; Dr. Thomas T. Goldsmith, Jr., Allen B. Du Mont Laboratories, Inc., Passaic; David B. Smith, Philco Radio and Television Corp., Philadelphia; O. B. Hanson, National Broadcasting Co., New York; Robert Shelby, National Broadcasting Co., New York, alternate; E. A. Hayes, Hughes Productions, Los Angeles; George Lewis, Federal Telephone and Radio Corp., Newark; Harry Lubcke, Don Lee Broadcasting System, Hollywood, and H. L. Blatterman, Earle C. Anthony, Inc., Los Angeles.

Raytheon Chicago Outlet

Raytheon Mfg. Co., which already has on file with FCC an application for the 44-50 mc No. 1 channel in New York, has asked for the same channel in Chicago. Application was filed early in March.

Home Audiences

According to Ross Federal Research, the average home audience for television is 5.6 persons. This breaks down to 4.3 adults and 1.3 children under 18. In public places, the average is 37.3 viewers, 36 adults and 1.3 children.

French Experts Here

Two French television technicians are here to study American engineering and programming methods. They are Pierre Garigues, head of the technical information service for Radiodiffusion, Paris, and Pierre Schaeffer, engineer for the same organization. Office of War Information arranged the visit and will shepherd the engineers.

Theater Television

The motion picture people, as represented by the Society of Motion Picture Engineers plan a theater television service "in the immediate postwar period with equipment now known to be available." That is provided FCC will allot for such services a band of 160 mc between 600 and 760 mc and one of 140 mc between 860 and 1000 mc. They want, also the high frequency band now earmarked for television

experiments—480-920 mc—to be made available for theater work on a "parity of opportunity basis" with television broadcasting. They point out that "if, as a result of the experimental use of the frequencies between 480 and 30,000 megacycles, it is found that theater television can make the best use of a portion of the band between 480 and 920 megacycles, all factors considered, the Commission give consideration to the assignment of such a portion for commercial theater television."

Improving Reception

As a matter of practical interest to the public and of possible interest to engineers, Allen B. DuMont suggested at the recent FCC public hearings in Washington certain remedies which the experience of his company has found valuable in improving reception service particularly in metropolitan areas. He said:

"Complaints regarding reception within a radius of 10 miles of the transmitter invariably mention seeing pictures 'double,' with practically no comments on the signal being weak. We have endeavored to contact these listeners and show them how they could change their antenna installation to eliminate or greatly reduce the multiple images caused by reflections from tall buildings, bridges, etc. At distances greater than 10 miles occasional listeners complain of: (1) weak picture and sound signal, and (2) weak sound signal.

"On investigating these complaints, we find that when both the picture and the sound are weak, this can practically always be remedied by a proper antenna installation and the use of a good lead-in wire. Many of the antennas installed early in the game had sharp cut-off and poor lead-ins so that the signal on Channel No. 1 would be received much stronger than on the higher frequency Channels such as No. 2 and No. 4, the loss being particularly great on Channel No. 4. By the installation of a broad band antenna and the use of coaxial cable in practically all cases equal signal strength could be obtained on Channel No. 4 as on Channel No. 1.

"In the cases where a good picture was received but a weak sound signal, we found that this was generally due to improper line-up of the receiver, and when Channel No. 4 was lined up the sound would come in satisfactorily.

Rush for "Time"

The rush for television "time" has started. More than three score advertising agencies have installed special departments to handle video shows and arrange for their exhibition. With 90 or more applications for tele stations on file with FCC and not too many channels available per trading area it begins to look like first come first served among those who want to use the new advertising medium.

Television Is Ready

Television should be operating at good enough strength and as a growing medium of information and entertainment within one year after V-E day in the opinion of John F. Royal, NBC vice-president in charge of television. It is good enough right now, he declares in an article in Musical Digest—as good as, if not better, than radio was in the early nineteen twenties.

Du Pont Electronics Group

A new electronics group has been formed in the rayon department of E. I. du Pont de Nemours & Co. and will be concerned with the application of electronic technics in the production of synthetic fibers and films. The new group will be in the charge of L. P. Haner.

BATTER UP!



When the old ball season opens WNBT may likely again set up a remote pickup like this to relay the games to its transmitter located atop the Empire State Building in New York

*Title registered U. S. Patent Office.

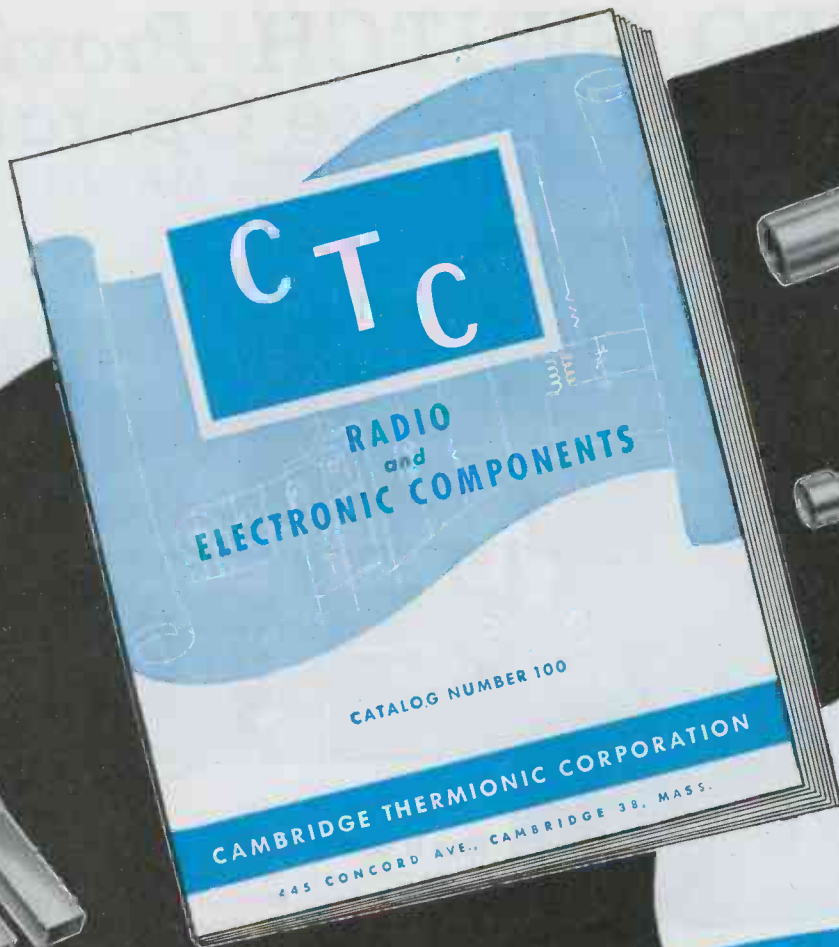

YOU NEED THIS BOOK!

It contains complete information on recent C. T. C. radio and electronic components designed to speed production and improve the performance of precision equipment.

You'll discover how the new line of C. T. C. Terminal Lugs and Swaging Tools saves time and money through faster, cleaner assembly. It contains specifications for C.T.C. Crystals and facts about a thumb-size I-F Ultra-High Frequency Transformer.

You need this book for your files. Write for your copy today.



CAMBRIDGE THERMIONIC CORPORATION
441 CONCORD AVENUE • CAMBRIDGE 38, MASSACHUSETTS

MICRO SWITCH Provides Automatic, Precise Operation

FOR THIS SIMPLEX BORING MACHINE

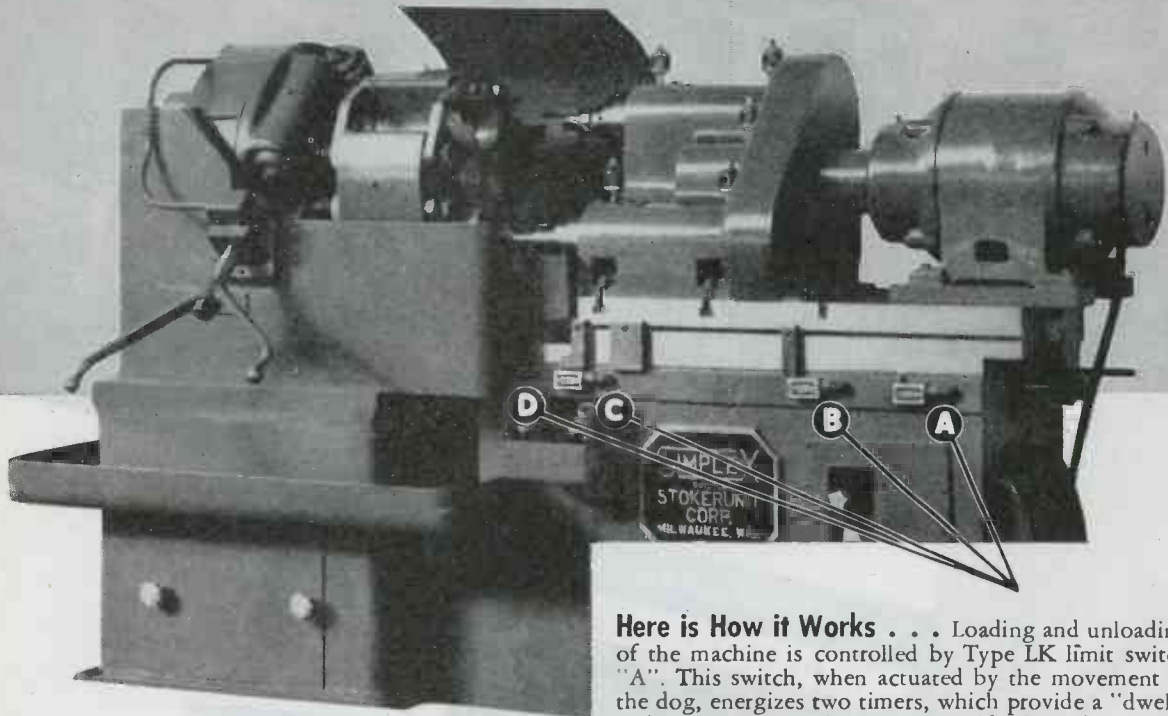

Here is How it Works . . . Loading and unloading of the machine is controlled by Type LK limit switch "A". This switch, when actuated by the movement of the dog, energizes two timers, which provide a "dwell" and also a time cycle on a solenoid which furnishes a return to the table.

Steel clad switch "B" controls the limit of the return table travel after the boring cycle is completed.

As the head travels up to the work, the dog trips steel clad switch "C" which opens to de-energize a solenoid allowing a coarse feed travel. At the completion of the coarse feed travel, a dog contacts steel clad switch "D" which closes to energize another solenoid giving a fine feed travel.

Five other switches, not visible, control operations of the spindle motor and the coolant pump and regulate the speed of operation.

Ruggedness and dependability of the sensitive "Micro Switch" snap-action switches is amply illustrated by their use in the automatic control of the Simplex Precision Boring and Facing Machine made by the Stoker Unit Corporation of Milwaukee, Wisconsin.

Every step in the operation of this precision machine, designed for boring and facing shells, is controlled by the use of nine switches so located as to regulate the sequence of operations of the automatic cycle.

This machine consists of a fixture and spindle head. The fixture rotates about a horizontal axis and is hydraulically indexed to four different positions in each complete cycle. The "Micro Switch" snap-action switches automatically control the feeding cycle on the table which carries the three-spindle boring head. Four of these switches are visible in this illustration.

Do You Need a Switch To . . . control temperatures, help to package products, bottle fluids, record airplane flights, make change, dispense drinks, heat water, control electronic tubes, or steer ships? "Micro Switch" snap-action switches successfully control many such operations . . . and thousands more. "Micro Switch" engineers, experienced in the application of millions of these precise, snap-action switches to products for both war and peace, will be glad to show you how they can add long life and reliability to your product at lower cost. Write for the "Micro Switch" Handbook-Catalog today.

LET'S ALL BACK THE ATTACK

BUY EXTRA WAR BONDS

© First Industrial Corporation

MICRO MARK
TRADE **MS** **SWITCH**

A DIVISION OF FIRST INDUSTRIAL CORPORATION

Freeport, Illinois, U.S.A., Sales Offices in Principal Cities



The basic switch is a thumbsize featherlight, plastic enclosed, precision snap-action switch. Underwriters' listed and rated at 1200 V. A., at 125 to 460 volts a-c. Capacity on d-c depends on load characteristics.

Accurate reproducibility of performance is maintained over millions of operations. Basic switches of different characteristics are combined with various actuators and metal housings to meet a wide range of requirements.

LET US DEMONSTRATE WHAT ELECTRONIC HEATING can do for YOU

PROOF BY TRIAL . . . that's our motto. Before you invest in electronic heating equipment you should be shown how any process requiring heat can be done *better, faster and more economically* for you with a Scientific Electric unit.

Our engineers will gladly—*without obligation*—make a study of the heating process under consideration. They will then make recommendations supported by practical demonstrations on the S.E. heater best suited for the job.

This procedure will enable you to figure accurately the economies that will result; also permit you to estimate the time required to pay for the equipment out of resultant savings.

You can submit your heating problems to us with the assurance that absolute secrecy will be observed, if so desired. Investigate the advantages of applying electronic heating in your manufacturing operations **NOW**. Consult with us at your earliest opportunity.

Write for free copy of
The ABC of Electronic Heating

**Manufacturers of
Vacuum Tube and Spark Gap Converters Since 1921**

Scientific Electric

DIVISION OF "S" CORRUGATED QUENCHED GAP COMPANY

119 MONROE ST.  GARFIELD, N. J.



18KW
INDUCTION
HEATER

40KW
INDUCTION
HEATER

60KW
INDUCTION
HEATER



3 KW DIELECTRIC HEATER
Dielectric Heating Units priced from **\$1500.**
(3 KW complete)

5 KW INDUCTION HEATER
Induction Heating Units priced from **\$1285.**
(for 5 KW complete with 1 work coil)

Scientific Electric Electronic Heaters are made in the following range of power; 3—5—7½—8—10—12½—15—18—25—40—60—80—100—250 KW.—and range of frequency up to 300 Megacycles depending on power required.

More than **35** Years of
Service

to the
**RADIO
INDUSTRY**



Whether Amplitude Modulation . . . Frequency Modulation . . . or Television — dependability is a *must* for all broadcast equipment.

Federal broadcast equipment has earned a reputation for that dependability because *it stands up*.

For more than thirty-five achievement-studded years . . . from the Poulsen Arc to the new CBS Television Station . . . Federal has served the broadcast industry with superior equipment.

Federal's background includes such milestones of electronic progress as the 1000 Kw Bordeaux Transmitter; Micro-ray, the forerunner of modern television technique; and the first UHF multi-channel telephone and telegraph circuits, part of a world-wide communications system . . .

All this, plus the war-sharpened techniques that are the result of ability *and* experience, combine to give you craftsmanship . . . the kind of craftsmanship that builds dependability into all Federal equipment.

In AM . . . FM . . . TV . . .

. . . your prime need in broadcast equipment is dependability — *look to Federal for it.*



Federal Telephone and Radio Corporation



Newark 1, N. J.

ELECTRONIC INDUSTRIES • April, 1945

WHAT WILL YOU NEED TO PRODUCE BETTER POST-WAR PRODUCTS ?

**CORNING
GLASS
GIVES YOU**

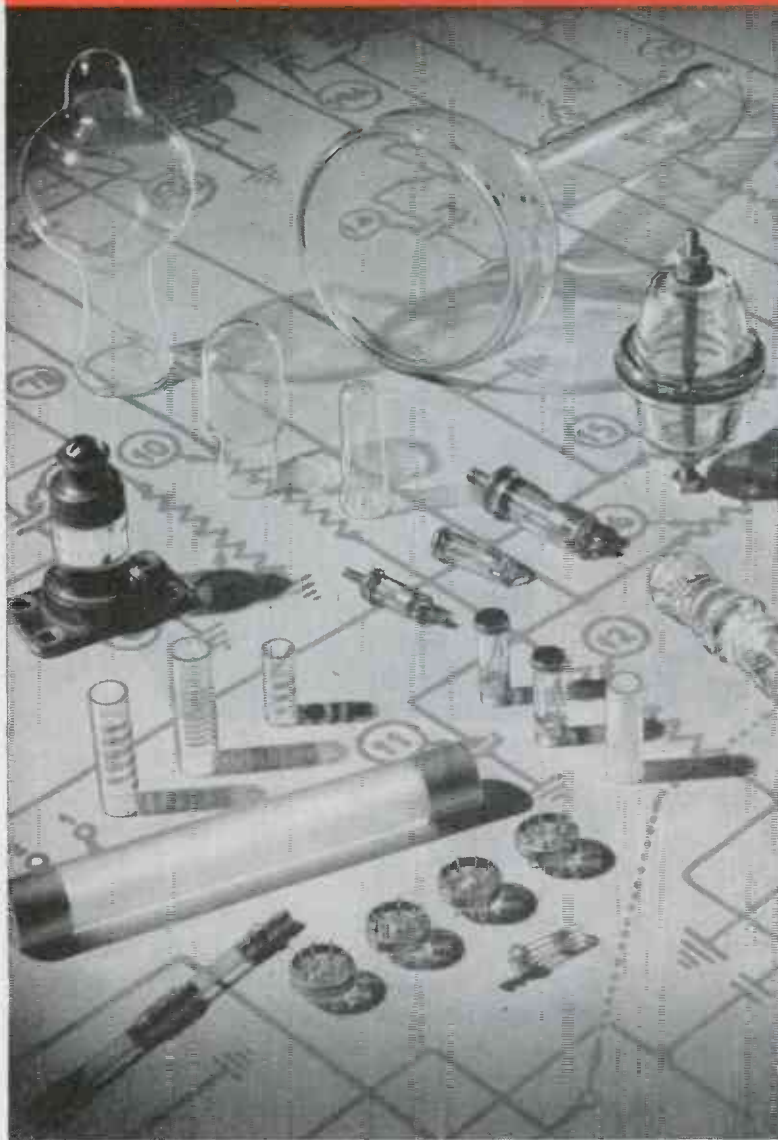

Special Electrical Qualities

Thermal Endurance

Hermetic Sealing

Mechanical Strength

Corrosion Resistance

Precision

Permanence

Metallizing

Dimensional Stability

High dielectric strength — high resistivity — low power factor — wide range of dielectric constants — low losses at all frequencies.

Permanent hermetic seals against gas, oil and water readily made between glass and metal or glass and glass.

Commercial fabrication to the fine tolerances of precision metal working.

Corning's metallizing process produces metal areas of fixed and exact specification, permanently bonded to glass.

AS YOU plan post-war electronic products, give a thought to versatile glass. We really mean glasses, for Corning has, at its fingertips, 25,000 different glass formulae from which to select those especially suited to your electronic applications. Let us show what glass can do for you. We may already have a solution — or Corning Research can find the answer for you. Address Electronic Sales Dept., I-4, Bulb and Tubing Division, Corning Glass Works, Corning, New York.

CORNING
— means —
Research in Glass

Electronic Glassware



“PYREX”, “VYCOR” and “CORNING” are registered trade-marks and indicate manufacture by Corning Glass Works, Corning, N. Y.

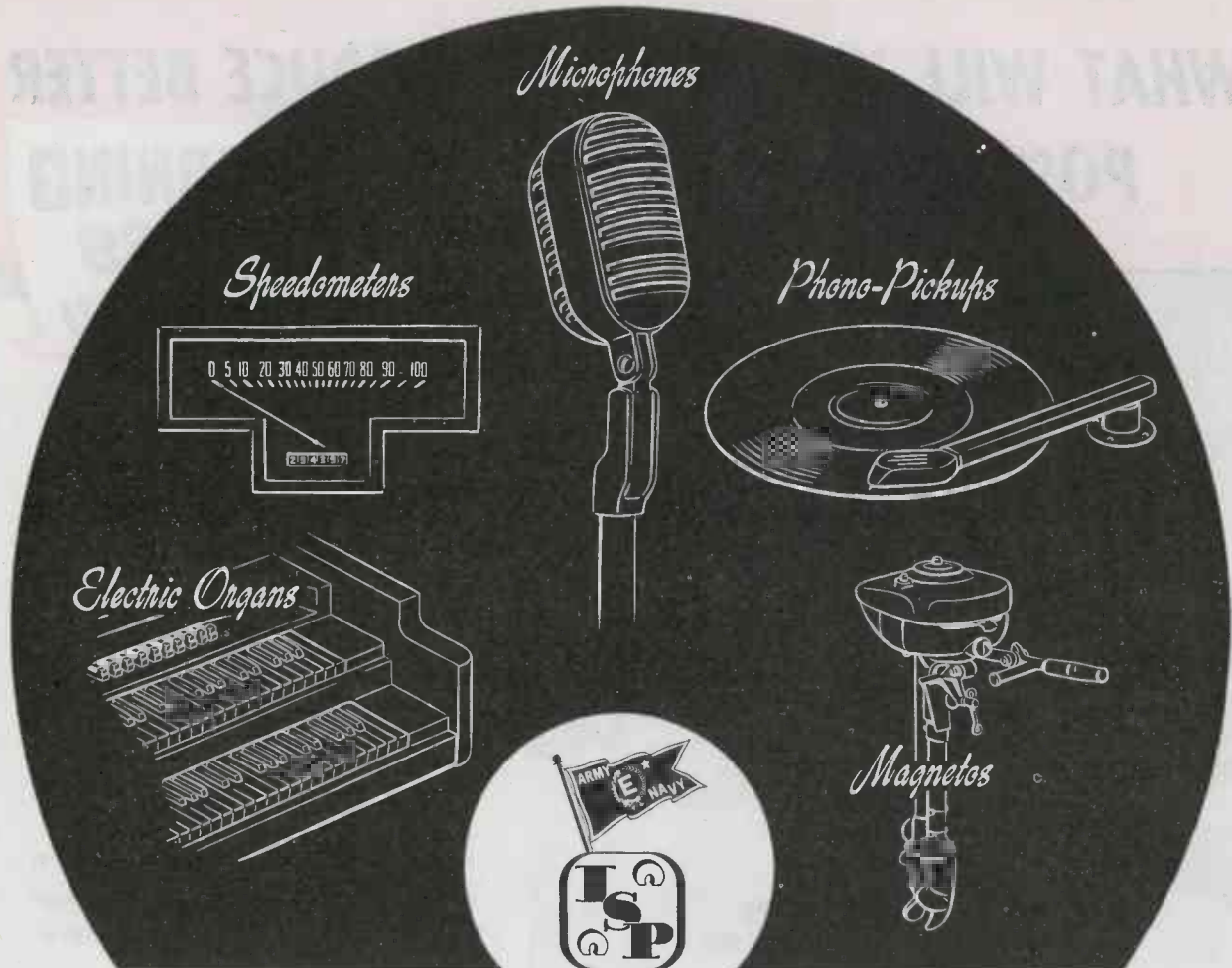

(This is the first of four advertisements discussing the major functions of permanent magnets)

ELECTRIC CURRENT from MECHANICAL ENERGY through PERMANENT MAGNETS

The ability to create an electric current through the agency of a permanent magnet suggests to the engineer or product designer a wide range of useful applications.

Permanent magnets are able to transform mechanical into electrical energy in two ways—

1. *By producing a magnetic field through which an electrical conductor is moved mechanically—as in*

the case of generators, magnetos and velocity or dynamic microphones.

2. *By acting as a polarizing agent, where reluctance to the magnetic circuit is varied by mechanical means; for example—the phonograph pick-up and inductor-type magnetos and generators.*

This characteristic of the permanent magnet permits its use for the generation of electricity for actual power uses, or to produce devices for the control, detection and measurement of many materials.

Backed by 34 years of experience as the largest exclusive manufacturers of permanent magnets, our engineers will gladly consult with you on problems where the use of permanent magnets may do the job better. Write for free copy of technical booklet: "Permanent Magnets Have Four Major Jobs".

★ THE INDIANA STEEL PRODUCTS COMPANY ★

6 NORTH MICHIGAN AVENUE • CHICAGO 2, ILLINOIS

Specialists in Permanent Magnets Since 1910

COPYRIGHT 1945, THE INDIANA STEEL PRODUCTS COMPANY



Only a few minutes' Set-Up Time

and you're ready to make a **NEW SIZE WASHER** when you use...

HOVIS

UNIVERSAL MASTER WASHER DIES

Once having made a nominal investment in Hovis Master Washer Dies to fit your requirements, all you need is to change five small easily removable parts to make a new size washer. This takes only a few minutes. Think of what this means in the saving of time, materials, process engineering, tool designing and tool tryout! And you can make washers on short notice as you need them, avoiding large inventories. The Master Dies themselves do not become obsolete. USE THEM FOR PRESENT AND POSTWAR PRODUCTION.

Write for illustrated folder.

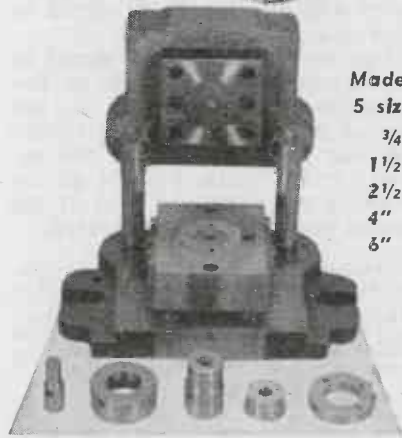

Made in 5 sizes:
3/4"
1 1/2"
2 1/2"
4"
5"

America's leaders in the electrical Industry have been making Washers the HOVIS WAY for more than 4 years from materials such as BERYLLIUM COPPER, COPPER, PHOSPHOR BRONZE, BRASS, SILVER SOLDER, FIBRE, MICARTA, BAKELITE, ASBESTOS PAPER, CARDBOARD, FISH PAPER, CANVAS, LEAD, STEEL, STAINLESS STEEL, FELT, RUBBER, LEATHER, MASONITE, VELLUMOID, ALUMINUM, DURAL.

HOVIS SCREWLOCK COMPANY

8096 E. NINE-MILE ROAD

Suburb of Detroit
Phone: Centerline 1575

VAN DYKE, MICHIGAN

LAMINATED PRECIOUS METALS

for New

INDUSTRIAL USES

Gold, silver, platinum and palladium or special precious metal alloys laminated to base metal have made these things possible . . .

- The desirable electrical, mechanical or chemical qualities of the precious metals have been added to the strength or other desirable properties of base metals, precisely where and as required.
- Precious metal properties of corrosion resistance, electrical superiority, and durability are obtained without solid precious metal costs.
- Uniform maintenance of lamination ratios with no porosity, pit marks or defects.
- Finer, more lasting finishes than are otherwise obtainable in base metals.

Recent production includes gold, silver, or specially developed precious metal alloys on copper, beryllium copper, invar, steel, inconel and pure nickel. Likewise, platinum and palladium are being laminated to inconel and pure nickel. We can manufacture sheet or strip of precious metal laminated to base metal in any combination of metals and in any quality or ratio, single or double plate, striped or edgelay.

To assist you in the application of our products to your products we are maintaining a staff of thoroughly experienced metallurgists, chemists, designers and consultants . . . an up-to-date research and testing laboratory . . . and a splendidly equipped tool room. These are all at your service to cooperate with your own staff to the full extent of our facilities.

Your inquiries are cordially invited. Ask, too, for a copy of our new descriptive folder.



Makepeace PRODUCTS

SHEETS • WIRE • TUBING • SOLDERS
FABRICATED PARTS AND ASSEMBLIES

D. E. MAKEPEACE COMPANY

Main Office and Plant, ATTLEBORO, MASS. New York Office, 30 Church St.

INTERFERENCE PROBLEMS

(Continued from page 91)

permit it to be modulated, then these signal to interference ratios become even higher due to the averaging effect of the swinging interference and the fact that only for frequency differences of 15 kc is the interference audible, greater frequency differences contributing only inaudible noise which is taken out by the low pass filter action of the audio amplifier.

From a mathematical standpoint, the foregoing analysis has taken certain liberties with the facts that would not be justified in a rigorous investigation. However, rigor was sacrificed in order not to "clutter up" the physical picture. These results are fully substantiated by measurements made in the field and reported in the literature.

I. R. Weir, reporting on field tests of common channel operation of AM and FM circuits⁵ noted that "a ratio of 40 decibels between the desired and interfering signals was obtained with frequency modulation when the input ratio is only two to one, or 6 decibels. A corresponding ratio of signal to interference with amplitude modulation is seen to require a far greater input ratio: i.e. 40 db requires an input signal ratio of about 100 to 1 or 40 db, as was to be expected."

Measurements reported by Plump³ show that "The effect of frequency modulation operation is such that when in the output of a conventional receiver, the noise is nearly 47 per cent of the maximum signal amplitude, good musical reception (2 per cent noise) is still possible." These measurements by Plump are without the use of de-emphasis. Taking into account the improvement possible by the use of de-emphasis would place his measurements well above a 40 db signal to noise ratio.

Thus we see, that for a signal to interference ratio of 40 db in the respective receiver outputs, in the case of AM the interfering carrier can only be 1 per cent of the desired carrier, while for FM an interfering signal 50 per cent of the desired carrier can be tolerated.

¹"Frequency Modulation Noise Characteristics" M. G. Crosby Proc. I.R.E. April 1937 p. 498.

²First reported and explained by E. H. Armstrong in "A Method of Reducing Disturbances in Radio Signalling by a System of Frequency Modulation." Proc. I.R.E. May 1936 p. 727-728.

³Actually, sinusoidal performance is only attained for large C/I ratios. An analysis of the factors involved as the C/I ratio approaches unity will not be attempted here. For further information see (a) M. G. Crosby; loc. cit. (b) "Störverminderung durch Frequenzmodulation," E. H. Plump Hochfrequenztechnik und Elektroakustik Sept. 1938.

⁴For de-emphasis curves see "The Service Range of Frequency Modulation" M. G. Crosby RCA Review Jan. 1940.

⁵"Comparative Field Tests of Frequency Modulation and Amplitude Modulation Transmitters." I. R. Weir Proc. of Radio Club of America, July 1939.

High Insulation Resistance

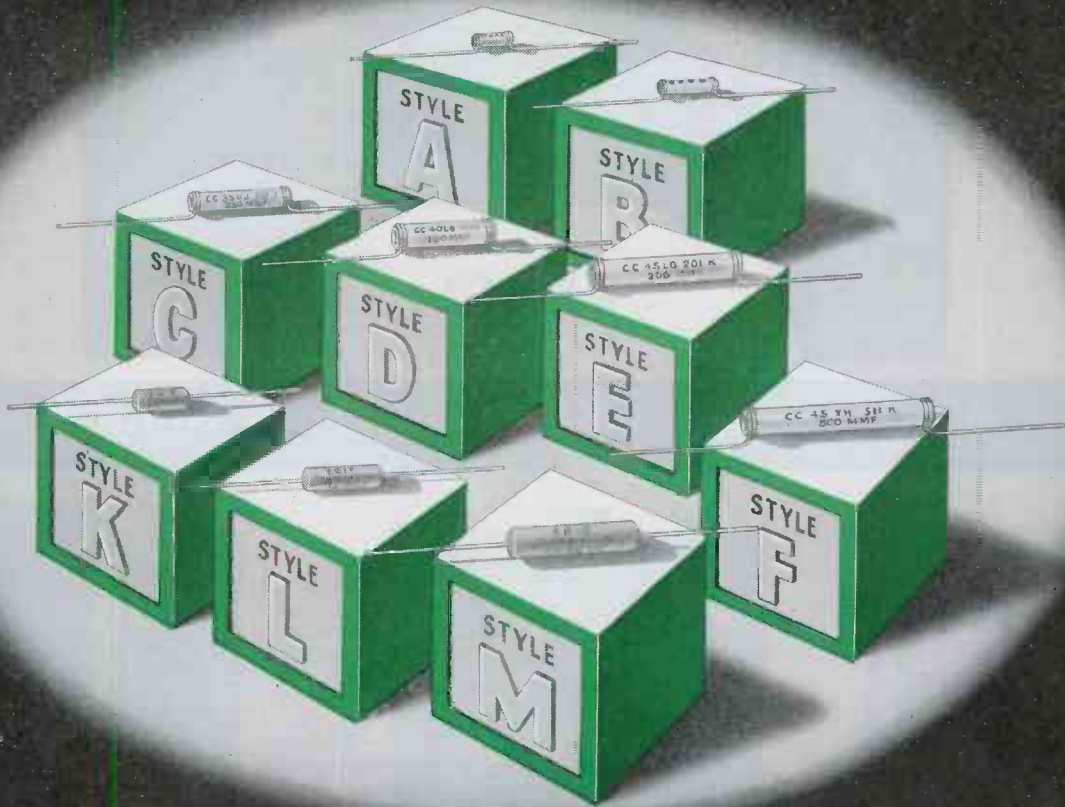

makes **ERIE CERAMICONS*** Excellent Coupling Condensers

REG. U. S. PAT. OFF.

ALTHOUGH Erie Ceramicons were originally designed and developed almost a decade ago primarily to provide engineers with a simple and effective method of compensating for frequency drift in other components. They are now being used in wide and varied types of applications with complete success.

For instance, Erie Ceramicons give excellent results when used as coupling condensers, particularly in plate to grid circuits, where high insulation resistance is of paramount importance.

The tremendous wartime demand for condensers has provided ample opportunity to prove the reliability and adaptability of Erie Ceramicons as extremely stable general purpose capacitors.

When specifying Ceramicons under JAN-C-20 for general pur-

pose use, temperature coefficient characteristics "SL" should be given. If Erie designations are used, specify "any temperature coefficient between P100 and N750." The temperature coefficient of these Ceramicons will be between +150 and -870 parts/million/°C.

In many cases, particularly in the low capacity ranges, these temperature coefficient limits will permit us to ship from stock, since the Ceramicons may be selected from any one of ten standard temperature coefficients between P120 and N750. The capacity range for equivalent physical size is given in the table at the left.

We will gladly send you samples of Erie Ceramicons for your general purpose applications.

CAPACITY RANGE IN MMF	JAN-C-20 STYLE	ERIE STYLE	MAXIMUM OVERALL DIMENSIONS
1 to 51	CC20 CC21	A K	.200 x .400 .250 x .562
52 to 110	CC25 CC26	B L	.200 x .656 .250 x .812
111 to 360	CC35 CC36	C M	.265 x 1.125 .340 x 1.328
361 to 510	CC40	D	.375 x 1.110
511 to 820	CC45	E	.375 x 1.560
821 to 1100	CC45	F	.375 x 2.00

* Ceramicon is the registered trade name of silvered ceramic condensers made by Erie Resistor Corporation.

Electronics Division
ERIE RESISTOR CORP., ERIE, PA.

LONDON, ENGLAND • • TORONTO, CANADA



★ ★ ★ Do More Than Before—Buy EXTRA War Bonds ★ ★ ★

KARP, AMERICA'S FOREMOST SHEET METAL SPECIALIST, IS GEARED TO PRODUCE



Broadcasting
Station Control Desk

TO YOUR SPECIFICATIONS SIMPLE OR COMPLEX UNITS OF ANY SIZE, IN ANY

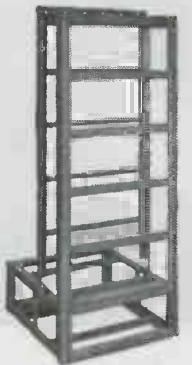

Relay and
Switch Gear Rack

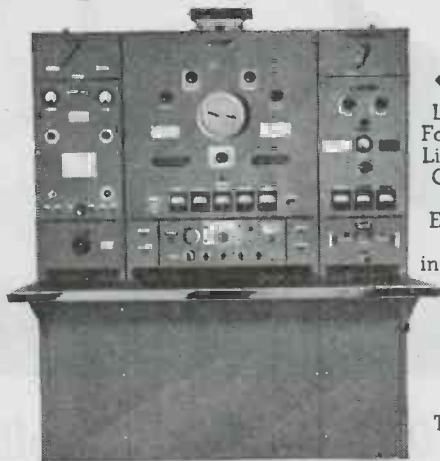

Left: Steel
Facilities for
Liberty Ship
Communi-
cations
Equipment
(without
instruments)

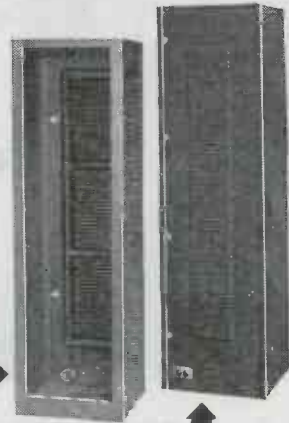

Relay or
Transmitter
Rack
Cabinet
(front view)

Relay or Transmitter
Rack Cabinet
(rear view)

QUANTITY, MORE EFFICIENTLY, MORE REASONABLY, AND ON SCHEDULE.

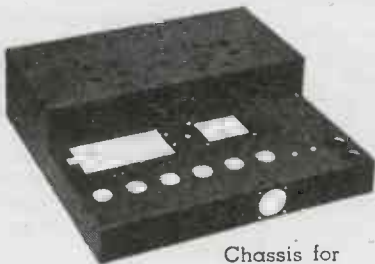

Chassis for
Link Trainer

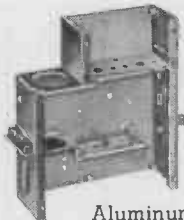

Aluminum
Radio
Shield

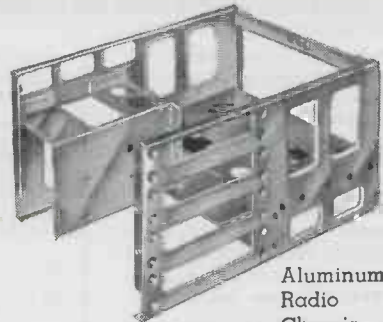

Aluminum
Radio
Chassis



KARP METAL PRODUCTS CO., INC.

126 30th STREET • BROOKLYN 32, N. Y.

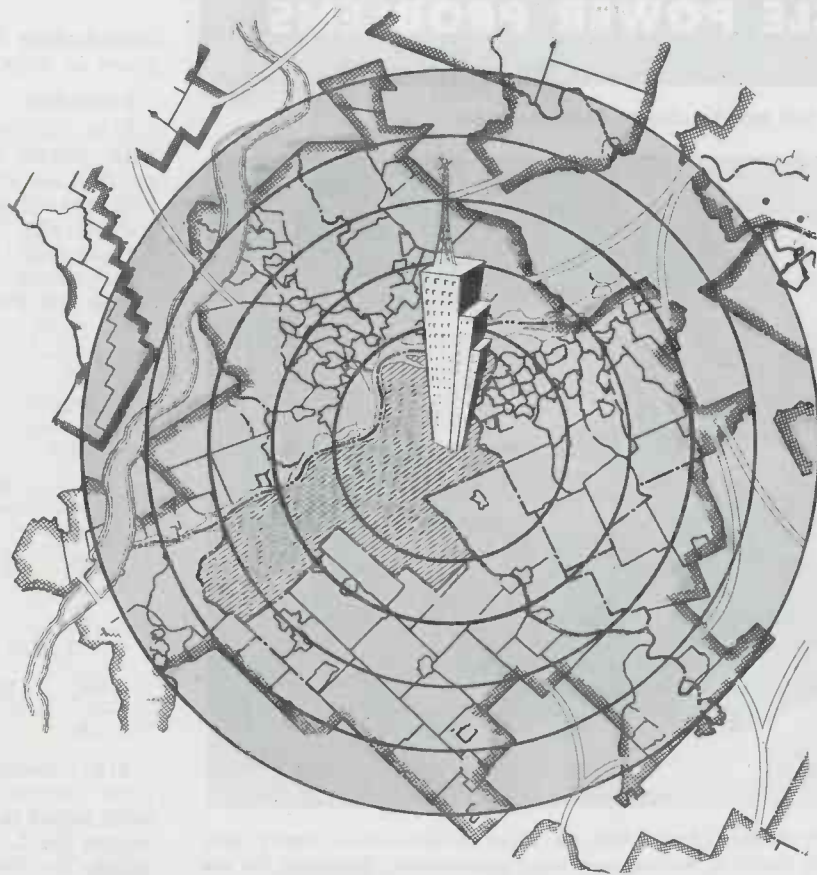

IS YOUR HAT IN THE TELEVISION RING?

Television promises unprecedented profit and prestige to men of vision and energy. Television will be tomorrow's highroad to local and national leadership.

If you plan to toss your hat in the Television ring, arrange *now* to assure both early postwar delivery of your telecasting equipment and the proper training of your Television station's operating personnel. Both equipment and staff training are provided for in DuMont's Equipment Reservation Plan.

DuMont-engineered telecasting equipment has

rugged dependability and practical flexibility; will be designed for economical operation and is realistically priced. These facts have been spectacularly demonstrated by more than 4 years' continuous operation in 3 of the nation's 9 Television stations.

Furthermore, a pattern for profitable station design, management and programming has been set at DuMont's pioneer station, WABD New York... a pattern and backlog of Television "know-how" which is available to prospective station owners. Call, write or telegraph today.

Copyright 1945, Allen B. DuMont Laboratories, Inc.

DUMONT



Precision Electronics and Television

ALLEN B. DUMONT LABORATORIES, INC., GENERAL OFFICES, 2 MAIN AVE., PASSAIC, N. J.
TELEVISION STUDIOS AND STATION WABD, 515 MADISON AVENUE, NEW YORK 22, N. Y.

PORTABLE POWER PROBLEMS

THIS MONTH—FISHER CARBANALYZER



TIME-**SAVING** carbon content analyses of steel samples—from molten metal to report—take only five minutes with the portable, *battery-powered* Carbanalyzer, produced by the Fisher Scientific Company. Leading steel firms employing open hearth or electric furnaces quickly make carbon determinations of each steel batch, achieving close control of quality.



CARBANALYZER, powered by Burgess Industrial Batteries, operates over a range of .05% to 1.50% carbon content and is sensitive to a change of $\pm .005\%$. The power requirements of modern control and test instruments are fully met by Burgess Industrial Batteries—the standard of quality for all commercial uses. The types you require may not be immediately available today since industrial battery production is greatly reduced by urgent war needs.

Burgess Battery Company, Freeport, Illinois



BURGESS BATTERIES



FOOD IS A WAR WEAPON—USE IT WISELY!

Famous for the WORLD'S MOST COMPLETE LINE of dry batteries

DESIGNING FILTERS

(Continued from page 78)

substituting the fractional values given in Figs. 4(a) and 5(a).

Examples:

3(a). Design a high-pass filter with shunt input and output to provide an attenuation of 15 db at 1000 cps with a load of 700 ohms.

From Fig. 1 it is seen that 15 db corresponds to $f_c/f = f_c/1000 = 1.05$, whence $f_c = 1050$ cps. Then the values for Fig. 4(a) are:

$$L = \frac{.159 R}{f_c} = \frac{.159 \times 700}{1050} = 0.106 \text{ h}$$

$$C = \frac{159000}{f_c R} = \frac{159000}{1050 \times 700} = 0.216 \mu\text{f}$$

$$\frac{5L}{3} = \frac{5(0.106)}{3} = 0.177 \text{ h}$$

$$\frac{5C}{8} = \frac{5(0.216)}{8} = 0.135 \mu\text{f}$$

$$L/2 = 0.106/2 = 0.053 \text{ h}$$

$$\frac{15C}{16} = \frac{15(0.216)}{16} = 0.2025 \mu\text{f}$$

3(b). Design a high-pass filter with similar characteristics but with series input and output. Figure values for L and C as above. Other values for use in Fig. 5(a) are:

$$\frac{15L}{16} = \frac{15(0.106)}{16} = 0.093 \text{ h}$$

$$\frac{5C}{3} = \frac{5(0.216)}{3} = 0.36 \mu\text{f}$$

$$\frac{5L}{8} = \frac{5(0.106)}{8} = 0.066 \text{ h}$$

$$C/2 = 0.216/2 = 0.108 \mu\text{f}$$

4(a). Design a high-pass filter (with shunt input and output) to provide an attenuation of 3 db for 75 mc with a load of 50 ohms.

From Fig. 1 it is seen that 3 db corresponds to $f_c/f = f_c/75 = 1.05$, whence $f_c = 79$ mc. Values for Fig. 4(a) are:

$$L = \frac{.159 R}{f_c} = \frac{.159(50)}{79} = 0.1063 \mu\text{h}$$

$$C = \frac{159000}{f_c R} = \frac{159000}{79 \times 50} = 40 \mu\mu\text{f}$$

$$\frac{5L}{3} = \frac{5(0.1063)}{3} = 0.177 \mu\text{h}$$

$$\frac{5C}{8} = \frac{5 \times 40}{8} = 25 \mu\mu\text{f}$$

$$L/2 = 0.1063/2 = 0.053 \mu\text{h}$$

$$\frac{15C}{16} = \frac{15 \times 40}{16} = 37.5 \mu\mu\text{f}$$

4(b). For a high-pass filter (with series input and output) to pro-

Here They Are!



The New

**1½
INCH**

G-E PANEL INSTRUMENTS

To meet the need for compactness, especially in electronic and communication devices for combat, they have a body diameter of only 1½ inches, are less than 1 inch deep, and weigh only 3 ounces. They are accurate to within ± 2 per cent.

These instruments are of the internal-pivot construction, and in addition to small size and light weight, they have all the other desirable features associated with this unique G-E design.

Because of its high torque and large-radius pivots, the element (which is common to both instruments) is well able to withstand vibration. High torque combined with a lightweight moving element results in fast response. Good damping makes for ease and accuracy of reading. Large clearances help to insure reliable operation.

All these features add up to a high factor of merit and all-round excellent performance.

For advance information, ask the nearest G-E office for Booklet GEA-4380, or write to General Electric Co., Schenectady 5, N. Y.

WATERTIGHT

TYPES DN-1, -2, -3
(Left hand, above)

● For applications where equipment may be used in an extremely humid atmosphere, exposed to rain, or accidentally submerged in water. Available for direct-current (DN-1), radio-frequency (DN-2), and audio-frequency (DN-3) service.

CONVENTIONAL

TYPES DN-4, -5, -6
(Right hand, above)

● For use on aircraft and on communications or electronic devices where the instrument is protected. Available for direct-current (DN-4), radio-frequency (DN-5), and audio-frequency (DN-6) service.



**HEADQUARTERS FOR
ELECTRICAL MEASUREMENT**

Buy all the Bonds you can—and keep all you buy

THEY'RE G-E INTERNAL-PIVOT INSTRUMENTS

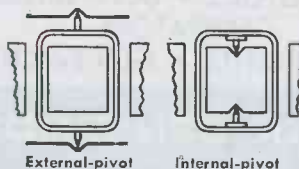

One advantage of the internal-pivot design is compactness. Armature, core, control springs, pivots, jewels, balance weights, and pointer form a single, self-contained unit, all parts of which are supported by a cast-colum magnet.

GENERAL  ELECTRIC

602-88-8200

PINCOR



DC MOTORS

BX SERIES

The urgent demand, in peacetime days, by the aircraft and radio industries for a compact, efficient D.C. motor was the challenge that led Pioneer to develop the Pincor BX series. Today Pincor BX motors flow from our plant in a steady stream to the producers of aircraft and radio equipment for the armed services.

Pincor BX motors, in their classification, meet the varied requirements of aircraft and radio manufacturers that demand light weight, compact motors for efficient and dependable application. Pincor BX motors are direct drive, ball bearing, high speed units wound for continuous or intermittent duty. Shunt, series or split series windings are for operation on 12 to 24 volt battery systems currently used and may be easily modified to meet your product demand.

Depend on these rugged Pincor quality-proven motors in the BX series. Send your problem to Pioneer engineers and let them put their years of experience to work for you. Consultation with these men will not obligate you in the least.

DYNAMOTORS • CONVERTERS
GENERATORS
POWER PLANTS • GEN-E-MOTORS

PINCOR
Products

PIONEER GEN-E-MOTOR
CORPORATION

5841-49 DICKENS AVENUE CHICAGO 39, ILLINOIS

BUY MORE BONDS!

Export Office, 25 Warren Street, New York 7, U.S.A.
Cable Address: Simontrice, N. Y.

vide the same attenuation characteristics as the last get values for L and C as above. Other values for Fig. 5(a) are:

$$\frac{5L}{8} = \frac{5(0.1063)}{8} = 0.0664 \mu h$$

$$\frac{5C}{3} = \frac{5 \times 40}{3} = 67 \mu f$$

$$\frac{15L}{16} = \frac{15(0.1063)}{16} = 0.1 \mu h$$

$$C/2 = 40/2 = 20 \mu f$$

K- and m-type components

Figs. 4(b) and 5(b) show the four half-section components of Figs. 4(a) and 5(a) respectively. These are subject to the same comments as previously given for low-pass half-sections.

The foregoing calculations are sufficient to meet the needs of the great majority of practical cases. Any errors that may be introduced by neglecting coil resistance and condenser conductance are usually less than the errors due to variations in the values of available inductances and capacitances. In any case they are revealed when a filter is tested for performance. They can then usually be corrected by slightly changing the inductance of a coil in accordance with the formula

$$f_c = 1 / (2\pi\sqrt{LC})$$

Band-pass filters for a specified bandwidth between an upper and lower cut-off frequency can be improved by series connection of a high-pass section designed to cut off at the lower frequency and a low-pass section designed to cut off at the higher frequency.

Mica Ceramic Insulation

A twelve-page bulletin, published by Electronic Mechanics, Inc., 70 Clifton Blvd., Clifton, N. J., presents a complete discussion of the advantages and disadvantages of all types of insulation and states the case for Mykroy perfected glass-bonded mica ceramic No. 51 in its application to injecting molding. It shows a large variety of electronic parts now being molded with and without metal inserts. Nine superior properties are listed with an extensive list of recent application of Mykroy molding of intricate parts. Four pages are devoted to design criteria for molding Mykroy, giving specific pointers on right and wrong practice in planning pieces for molding. Several pages are devoted to tables and charts giving the electrical, mechanical and physical properties in considerable detail on the various grades of Mykroy.

Protection starts here
by controlling

vibration

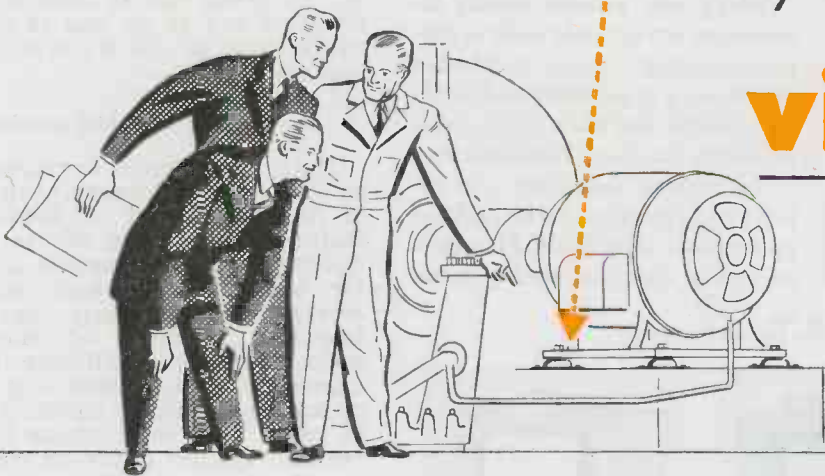

YOU remember the old story about the lost nail—and the shoe, the horse, the rider, the general, the battle, and the war that went haywire in consequence. The story doesn't begin soon enough — the nail was lost because of vibration.

In your plant or your product, it may be a screw . . . a bolt instead of a nail; a motor instead of a horse; but it's still vibration that starts the trouble. And you can sink two-foot bolts into the concrete base, but still you haven't kept the motor from shaking itself to pieces, or diminished the nerve wracking noise that's keeping morale and production down.

For more than twenty years Lord's business has been the isolation and control of vibration. Lord has lifted the methods of attack on the destructive forces of vibration to a highly developed science. When Lord engineers make a study of your plant or your product, there's no guesswork about their recommendations.

Lord Shear Type Mountings and other Bonded Rubber Products embody many exclusive techniques and patented features which cannot be copied.

Every genuine Lord Product has the name "LORD" molded into the rubber section, as a means of ready identification, and as a guarantee to the user that he is receiving Lord quality.

If you have a vibration problem, or a mechanical design problem involving the use of functional rubber, it may best be solved by means of rubber-bonded-to-metal. Call in a Lord Vibration Engineer, or write for literature on the subject. There is no obligation.



IT TAKES BONDED RUBBER *In Shear* TO ABSORB VIBRATION

LORD MANUFACTURING COMPANY
ERIE, PENNSYLVANIA

SALES REPRESENTATIVES
NEW YORK 280 MADISON AVE
CHICAGO 520 N. MICHIGAN AVE
DETROIT 7310 WOODWARD AVE.
BURBANK, CAL. 245 E. OLIVE AVE
CANADIAN REPRESENTATIVES
RAILWAY & POWER ENGINEERING CORP. LTD
TORONTO, CANADA

BUY MORE
WAR BONDS

Originators of Shear Type Bonded Rubber Mountings

How to build up a top-notch Testing Team!



Service Lab
Assembly of Standard Size Jackson Instruments

You don't have to do it all at once—just plan ahead and make every purchase count when you buy a new instrument. Then you'll be building up a perfectly-matched testing team—each a specialist, but each backing up the rest of the team.

That's why Jackson testing instruments are not only built to pinpoint accuracy—but are matched in dimensions, appearance and finish too. You can buy them singly, with assurance that they'll assemble into a combination balancing convenience and appearance with Jackson performance standards. Plan now to own a complete testing team.



Condenser Tester
Model 650A—Measures Capacity, Power Factor and Leakage



Sensitive Multimeter
Model 642—20,000 ohms per volt—complete ranges



Electronic Multimeter
Model 645—A new Jackson instrument of advanced design



Tube Tester
Model 634—Uses exclusive Jackson "Dynamic" Test Method



Multimeter
Model 643—1000 ohms per volt. Push key range selection

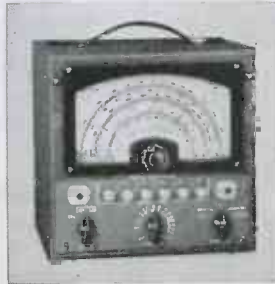

Test Oscillator
Model 640—Accurate to 1/2%, covers full frequency range

BUY WAR BONDS AND STAMPS TODAY



JACKSON

Fine Electrical Testing Instruments

JACKSON ELECTRICAL INSTRUMENT COMPANY, DAYTON, OHIO

ALLOCATIONS NEAR

(Continued from page 90)

102-108 mc band, either to independent facsimile broadcasters or to licensees in the same area who also operate sound (A-3) broadcasting stations in the AM or FM bands.

The mobile services, represented by Panel 13 chairman Daniel E. Noble, believes that the 102-108 band "is ideally suited for mobile communication requirements," and that this 6 megacycles should be assigned to that service on the basis of public interest, convenience and necessity. Under the proposed allocations general mobile radio telephone service is given three bands—7 channels between 156 and 162 mc, for urban use; 12 channels between 40 and 42 mc and 12 channels between 30 and 40 mc, both for highway use.

Heating problems

The heating people, as represented by Alexander Senauke, chairman of RTPB Panel 12 on Industrial Heating Applications, believe that the three narrow channels allotted for both industrial and medical services, are insufficient. That the frequency tolerance of plus or minus .05 per cent is difficult, if not impossible of attainment and that no known method of shielding can be relied upon to eliminate interference; neither is crystal control considered to be a satisfactory solution of the interference problem. The brief points out that "if a wide band or bands are not made available, or the narrow channels recommended are pulled in to a width difficult to attain, the allocated frequencies will prove unattractive and most of the equipments built and used will be of the self-excited oscillator type operating on frequencies spread over the entire spectrum, with probable concentrations of fundamental or harmonic radiations within the frequency modulation, television, and possibly safety service bands."

Subscription radio, which received no allocation in the original proposal, insists that this service can be looked upon as having public interest and in support of that statement submitted many letters as the result of a survey, which was made. They have, accordingly, asked that FCC "set aside . . . a suitable number of channels for a new and additional system of radio broadcasting." Their plan, it may be remembered, is to sell service to subscribers and to prevent others from enjoying the service by superimposing a "pig's squeal" on the program. Subscribers' radio sets would be equipped with a filter allowing them to eliminate the squeal and hear the program without interference.

CERAMIC DIELECTRIC TUBES

for
TEMPERATURE COMPENSATING
CAPACITORS

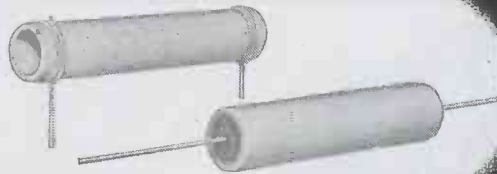

by **STUPAKOFF**

Stupakoff ceramic dielectric tubes have high dielectric strength, good power factor (less than 0.06%) and uniform electrical characteristics. They are available in all temperature coefficients from +120 to -750 parts per million per degree Centigrade. These tubes are employed in temperature compensating capacitors for eliminating frequency drift in RF circuits—also for bypass, lead-through and blocking capacitors.

Stupakoff manufactures a wide variety of ceramic dielectric materials. Inquiries are invited for Stupakoff ceramic dielectric tubes of the 3850 series used to produce capacitors in accordance with J. A. N. specification C-20, and also for those having special electrical characteristics. Stupakoff is prepared to give prompt delivery in large quantities, of ceramic dielectric tubing in a complete range of sizes and coefficients. Your inquiries—whether for specialized or standard ceramic dielectric tubes—will receive prompt attention.

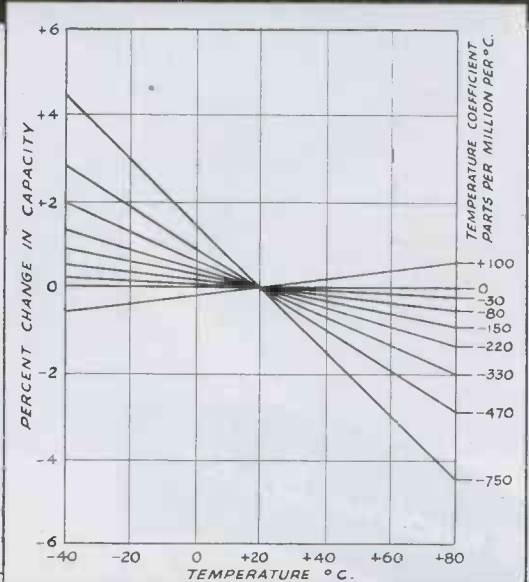

TEMPERATURE COMPENSATION OBTAINED WITH VARIOUS TEMPERATURE COEFFICIENTS OF CAPACITY

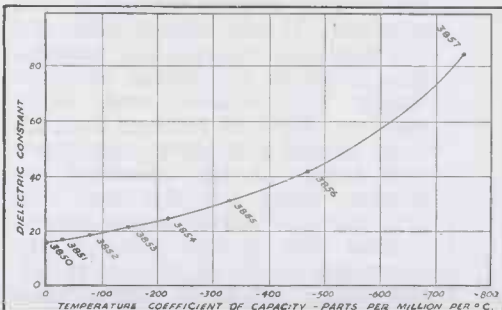

CHARACTERISTICS OF STANDARD "3850 SERIES" BODIES

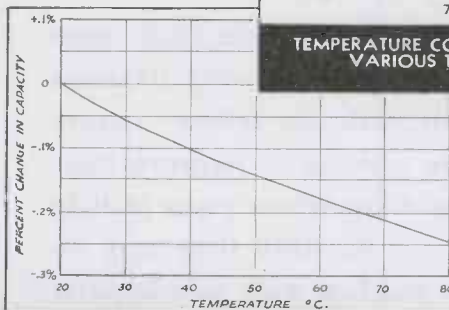

TYPICAL TEST CURVE OF A CONDENSER MADE FROM "3850 SERIES" MATERIAL



BUY MORE WAR BONDS

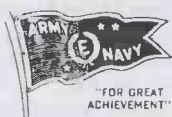

STUPAKOFF CERAMIC AND MANUFACTURING CO., LATROBE, PA.

Ceramics for the World of Electronics

STANCOR

Precision-Built TRANSFORMERS

Precision-Built

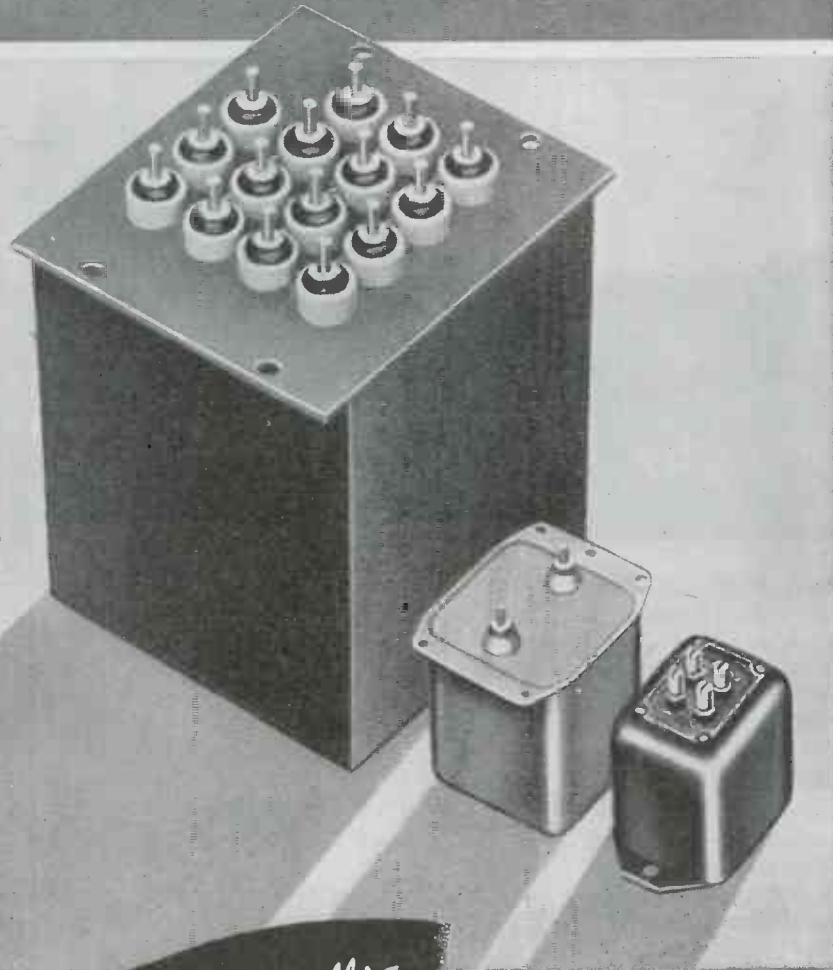

Breathing Spells-

We do have a little time—now and then only—to discuss transformer applications with our fellow “victory manufacturers” who are seeking to improve their war-time units and—also those whose plans include design for the future . . . Possibly time may be found for *you*. We’ll do our best with your inquiry.

STANDARD TRANSFORMER CORPORATION
1500 NORTH HALSTED STREET, CHICAGO 22, ILLINOIS



DC PIX TRANSFER

(Continued from page 107)

by repetition of the grid current process, restore the small amount of charge that is lost during the intervals between pulses.

If a change in the symmetry of the signal about the ac axis produces a new synchronizing reference height, the amount of charge on the condenser will change correspondingly. In other words, the dc grid bias on the tube automatically varies in accordance with the amplitude of the video signal and thus the peaks of synch. will always fall at the same point of the operating characteristic of the tube indicated by “P” in Fig. 3. This effectively ties the synch. level definitely to a fixed video amplifier plate current which results in a fixed value of dc voltage on the kinescope grid. It should be kept in mind that the illustrations of wave forms given in the samples generally occur several frames apart and the transition in dc setting is much more gradual than indicated in this approximate analysis.

Mobilization processes

Having shown the advisability and necessity of introducing dc setting at the receiver, it will be interesting to review the process of transmitter modulation. In television transmitters where we deal with modulation frequencies from practically dc to 5 mc. depending on picture content and rate of change of scene, it has been found most feasible to grid-bias modulate the transmitter, as such a system represents the most practical way at the present time of obtaining satisfactory modulation without the expenditure of prohibitively large modulating power.

Grid bias modulation merely varies the dc operating bias of the output rf amplifier at video frequencies under conditions where the rf grid driving voltage is held constant. If the output tubes did not take grid current, bias modulation could be considered as practically electro-static and hence wattless. Straight forward comparisons of grid and plate modulation, well known to all broadcast engineers, bring out the fact that grid-bias modulation can be accomplished with smaller tubes in the modulator at the expense of rf output stage efficiency, while plate modulation gains in output stage efficiency at the expense of large modulating power.

The familiar curve of grid voltage vs. antenna current for constant rf excitation of a grid-bias modulated amplifier is shown in Fig. 4. It is apparent that in order to modulate the transmitter successfully with a

two-day curing job.. cut to 7½ minutes



Cross section of grinding wheel . . . formerly oven baked . . . heat soaks in slowly from surface.



Same section . . . now cured by radio-frequency heating . . . heat builds up speedily, evenly throughout.

The old, slow oven cure took 48 hours—just to heat the resin bond of a grinding wheel 8½" in diameter by 1¼" thick.

Now 7½ minutes are plenty . . . heat mounts at 20°C per minute . . . and splitting due to uneven heating is no longer a major hazard. Now it's done by radio frequency which heats dielectrics uniformly from center to skin.

This speedy heating is often applicable to processes in wood, chemicals, plastics, rubber, textiles and dozens of other products—with no waiting for heat to "soak in" and no rejects due to overheated surfaces.

This accurate, uniform heating is simplified into a "push button" job for unskilled help, with all equipment and controls in one safe, spacesaving cabinet. The cabinet is shielded to minimize interference with radio communications.

Single standard units are available in output capacities ranging up to 200 kw. The range of frequencies is wide enough for almost every dielectric and induction heating need. For more information, write for Descriptive Data 85-800. Or, for suggestions on a specific application, ask a Westinghouse engineer to call. Westinghouse Electric & Manufacturing Co., P.O. Box 868, Pittsburgh 30, Pa.

J-08097



2 KW RADIO-FREQUENCY GENERATOR

This unit has a nominal output of 2 kw. Controls and meters are all conveniently located on front panel. Circuit breaker and relays are readily accessible through the lower door on left side of cubicle.



Westinghouse

PLANTS IN 25 CITIES . . . OFFICES EVERYWHERE

Electronics at Work



NOW OUR SIGHTS ARE SET

for the Stars

Ever since the war began—and for some time previous—B & W engineering has been achieving in days what would normally have taken months. Production was quickly doubled and redoubled. Then it was doubled again.

Somewhere along the line, we began catching up with the tremendous demand placed upon us or the coveted Army-Navy "E" burgee would not now be here.

We're proud of this recognition. We were more than pleased when the Flag arrived—even though there was time for no more than a fervent 20-minute salute. There are still Air Inductors, variable capacitors and special electronic assemblies to be produced—in more intricate designs and in larger quantities than seemed possible only a few years ago. There are still stars to be added to our "E" burgee. There is still a war to be won!

BARKER & WILLIAMSON

AIR INDUCTORS • VARIABLE CONDENSERS • ELECTRONIC EQUIPMENT ASSEMBLIES

235 FAIRFIELD AVENUE, UPPER DARBY, PA.

Export: LINDETEVES, Inc., 10 ROCKEFELLER PLAZA, NEW YORK, N. Y., U. S. A.

video signal of the type shown in Fig. 2, the no-signal or ac operating point must be chosen so that any of the ac wave forms indicated will fall on the linear portion of this curve.

Again it can be seen that if the operating point is incorrectly chosen, for example, Point P, it is very easy to saturate white portions of the picture by cutting off the output tubes, or to compress the synchronizing signal by operating too close to the curved high power output portion of the curve, as, for example, at Point P₂.

Fig. 5 shows the rf envelope of the picture wave when ac transmission is used. In this representation it can be seen that synchronizing always represents an increase in radiated power, as does black, whereas white represents a decrease in radiated power. The peak power output depends entirely on the ac symmetry of the signal and the only invariant in the system is the ac axis of the modulation as previously discussed. As in sound transmission, with a symmetrical wave, the peak power radiated is four times the carrier or no-signal radiation.

American standards

The rf envelope of Fig. 5 shows transmission which has negative polarity, now standard in American television practice. The term negative polarity signifies that with an increase of illumination of the object being televised, there is a decrease in the radiated power. Positive transmission, used in England before the war, gives an increase in radiated power corresponding to increase in illumination. It is evident that with the ac system of transmission one must provide sufficient leeway on the modulation characteristic to allow for shift of black and white signals so that they always fall within the linear portion of the modulation curve and are neither compressed nor saturated.

By the use of devices very similar to the dc setter described for the kinescope circuit, it is possible to transmit the dc component of a picture. In this case, the peaks of the synchronizing pulses always correspond to the instantaneous peak radiated antenna current no matter what the picture content of the signal may be. Black level is specified to be 75 per cent of the peak (synch.) rf current in the antenna and full white, which corresponds to 100 per cent down modulation, gives zero or nearly zero antenna current. This system has several readily apparent advantages.

First, the full modulation characteristic is used to complete advantage as it is not necessary to

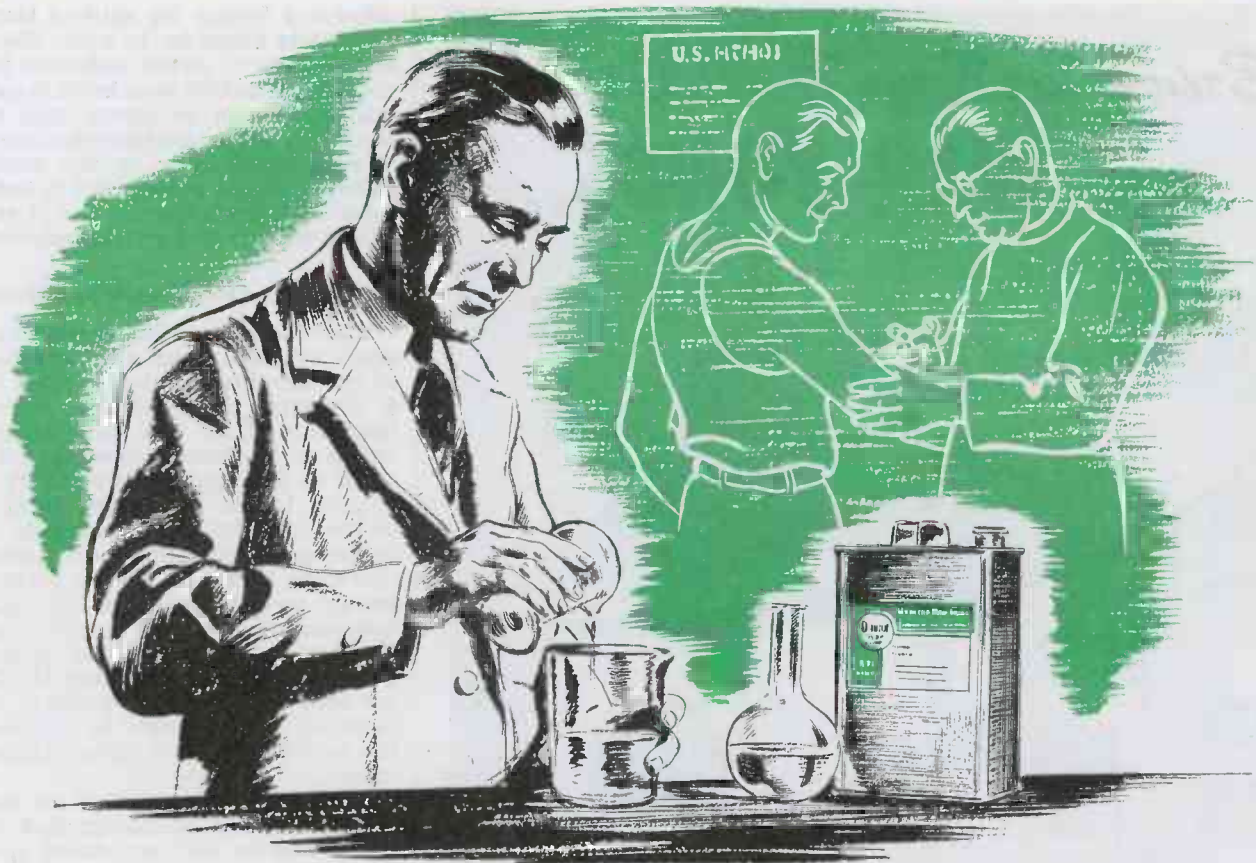

TROPICALIZED...

BOTH MEN AND COMMUNICATION EQUIPMENT NEED PROTECTION AGAINST THE TROPICS

Just as G. I. Joe is inoculated to protect him against germs before he sails for the tropics, so today are many delicate parts of communication equipment dipped and brushed with Tropicalized Q-Max A-27 H.F. Lacquer before it reaches the tropics and its performance enemy, fungi and mold.

To Q-Max research chemists, must go credit for finding the right fungicide-and-lacquer combination. Many effective fungicides were discarded because they were incompatible with the lacquer, or interfered with its good electrical characteristics, or its fine corrosion resistance.

But Q-Max "know how" found the correct fungicide and the Tropicalized lacquer is so effective that it not only fungus-proofs the coated area, but the untreated surfaces adjacent to the treated part as well.

In war or peace, it's always worthwhile to play safe and use Tropicalized Q-Max A-27 H.F. Lacquer to fungus-proof components of your electrical and communication apparatus. Specify "Tropicalized"—it's on the Q-Max label.

COAXIAL TRANSMISSION LINE & FITTINGS
STERLING SWITCHES
AUTO-DRY AIRE
ANTENNA & RADIATING SYSTEMS
TROPICALIZED Q-MAX A-27 H. F. LACQUER

Communication PRODUCTS COMPANY, INC.

Q-MAX CHEMICAL DIVISION: 346 BERGEN AVENUE, JERSEY CITY 5, N. J.

Bring Our Boys Home Sooner
with **WAR BONDS...**

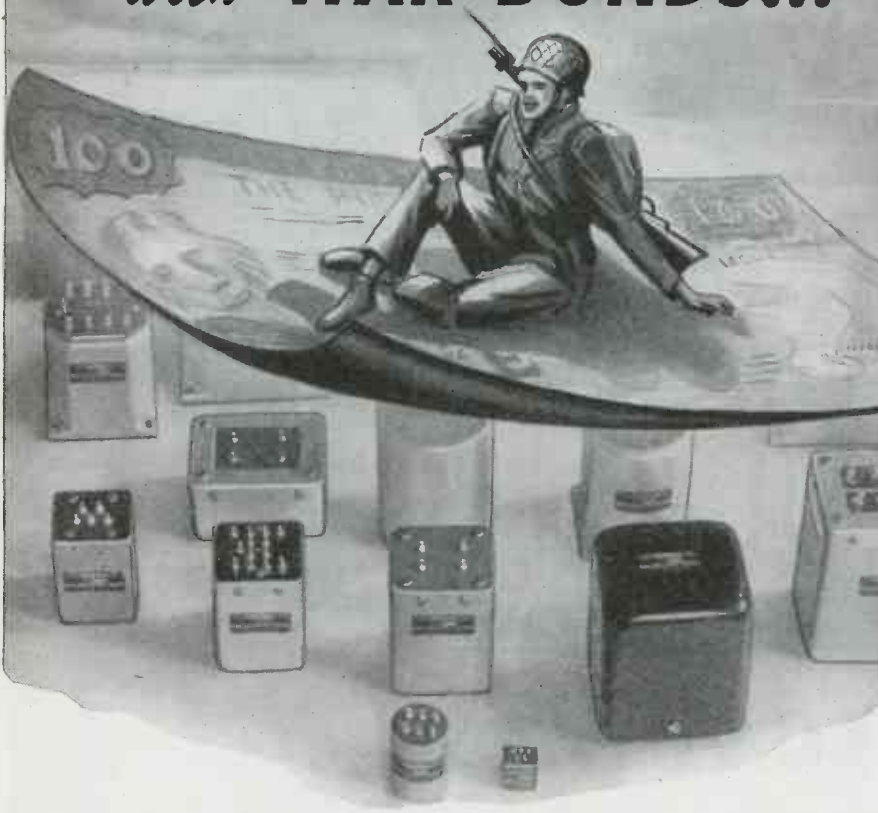

It's squarely up to us at home to finance the weapons of war as well as to build them. This is America's challenge. Here at ADC, we are exerting our energies to produce the finest communication components — and invest in as many War Bonds as possible. Believing that most Americans share our thoughts, we ask you to join us in this pledge — "Let us all continue purchasing War Bonds to the limit and bring our boys home sooner to a peaceful and economically sound country".

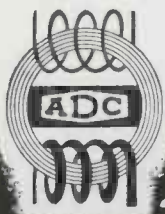

Audio Development Co.
2833 13th Ave. S., Minneapolis 7, Minn.

allow any leeway for shift of black and white about an ac axis. There is a definite rf power radiation for every illumination level being transmitted. It can be shown that by the use of the dc transmission there is an effective gain in the useful radiated signal power. Fig. 6 indicates the appearance of the rf envelope with dc picture transmission.

Peak synchronizing

The salient points which can again be emphasized are: the peak of synchronizing is always given by a constant peak radiated power, black and white also have unique values of radiated power as indicated in the figure. Moreover, it is possible to use the curved portion of the modulation characteristic to obtain synchronization power, since operation over this curved portion merely means that there is amplitude compression of synchronizing. By pre-emphasis of the synch. pulse, making it larger than the 25 per cent synchronizing pulse to be radiated, it is possible to increase the radiated power of a given transmitter.

In addition to providing for the correct average or background illumination in the reproduced picture, the use of dc picture transmission also improves conditions in the receiver, allowing for efficient operation without the possibility of if overload and making possible higher video levels at the output of the second detector. Moreover, avc operation from peaks of synch. can be satisfactorily used in receivers when a dc picture transmission system is used. Thus, the use of dc transmission leads to higher standard of television performance, resulting in more effective utilization of transmitter power, and in improved receiver performance over the complete video modulation range.

(Foregoing article appeared originally in "Broadcast News," published by RCA Division, Radio Corp. of America.—Editor.)

Electronic Products

A new 8-page condensed catalogue, "Norelco Electronic Products," has been issued by North American Philips Co., Inc., 100 East 42nd Street, New York. The subjects covered are: Cathode-ray, transmitting, power and amplifier tubes; quartz crystal oscillator plates; searchray (X-ray) inspection units; Geiger-counter X-ray spectrometer; film-type X-ray diffraction equipment; quartz crystal X-ray analysis unit; metallurgical products: tungsten and molybdenum powder, rod, sheet and wire, aluminum alloy, enamel copper, resistance, silver and gold-clad silver wire in fine sizes; medical X-ray equipment, radiographic units, tables, tubes, tube stands and miscellaneous accessories.

People who make Collins Radio

A few of the more than 3000 specialists who design and produce high quality radio communication equipment in the Collins plant.

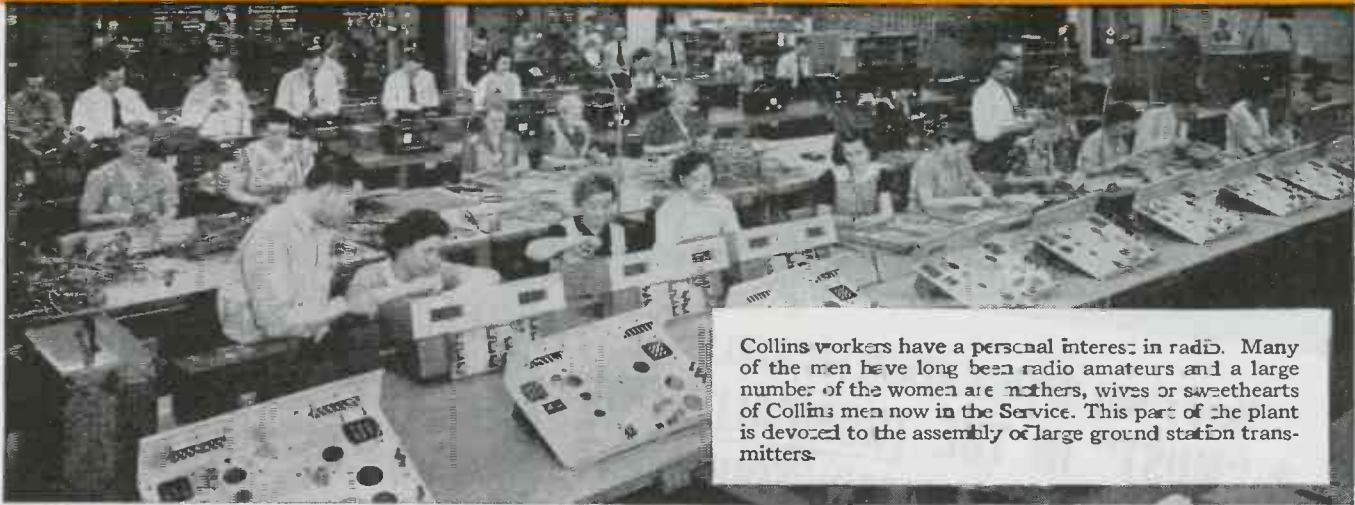

Collins workers have a personal interest in radio. Many of the men have long been radio amateurs and a large number of the women are mothers, wives or sweethearts of Collins men now in the Service. This part of the plant is devoted to the assembly of large ground station transmitters.



The technicians who wire the critical r.f. circuits in the exciter unit understand and why each wire must be located and terminated with great care, exactly as engineered.



These men know what it means to the field service man to have cables neatly positioned so that component terminals are accessible and item numbers in full view.



Collins is a radio man's radio organization. Men of high technical integrity have come here from all parts of the country because Collins standards are their own ideals of excellence.



Skilled mechanics assemble and synchronize the heavy duty Autotunes used on the output network of the 3000 watt Collins 231D ground station transmitter.



First line craftsmen assemble the Collins pi output network, which matches into a wide variety of single wire and vertical antennas.



Collins final-test men check every transmitter function critically, from the operator's point of view.



IN RADIO COMMUNICATIONS, IT'S . . .



Collins Radio Company, Cedar Rapids, Iowa; 11 W. 42nd St., New York 18, N.Y.

RCA REVEALS

(Continued from page 95)

RCA's automatic frequency control discriminates between the transmitted synchronizing impulse and any stray noise impulse, which otherwise might trigger the saw-tooth wave voltage prematurely, by fixing a time interval for the former and shutting out impulses which do not arrive on schedule.

Without some such control, noise interference could throw the scanning beam in the receiver out of synchronization with the one in the transmitter, causing the former to "black out" and return on some lines of the picture before they were completed. "Tear outs" and ragged edge effects would result. Preventing this form of distortion, the RCA system regulates reception in somewhat the same way that a fly-wheel regulates machinery. The large screen receiver is designed to sell for about \$3.95.

Here's why SPERTI HERMETIC SEALS are A "MUST" IN THE TROPICALIZATION OF ELECTRONIC MILITARY EQUIPMENT

1. EFFECTIVELY SEAL OUT DUST, sand, salt spray, fumes, fungus, injurious atmosphere.
2. GLASS PATH WILL NOT CARBONIZE. Have wide thermal operating range and high insulation leakage resistance.
3. SPECIAL PROCESS insures maximum acceptability to solder. Simple and easy to attach.

Sperti Hermetic Seals have been an important factor in increasing the life expectancy and usefulness of vital military equipment of many kinds. Write, today. Outline your problems. Let us show you how Sperti Hermetic Seals can help you solve them.

THE HELP YOU'VE BEEN LOOKING FOR!

Now available. Skilled assembly service for soldering terminals into cover plates. Send drawings and specifications for quick quotation. For full information, phone, wire or write.

Sperti

INCORPORATED
Cincinnati, Ohio



RESEARCH • DEVELOPMENT • MANUFACTURING

Broadcasters to Use 'Wattage' in IRE Campaign

Hundreds of radio broadcasters from coast to coast have been called upon to lend their support—in an unusual manner—to the campaign now being conducted by the Institute of Radio Engineers, to raise \$500,000 for the erection of a new building to carry on its engineering activities in radio and electronics.

In personalized letters addressed to every broadcaster of stations ranging from 100 to 50,000 watts, J. R. Poppele of WOR, chairman of the broadcast Division of the Initial Gifts Committee of the I.R.E. Building Fund, outlined how they can contribute to the erection of the new engineering center.

Radio stations operating under 750 watts of power were asked to contribute ten (10c) cents for each watt radiated by their transmitter. Stations operating over 750 watts of power were asked to contribute five (5c) cents for each watt. A 250 watt station, therefore, was requested to donate \$25 to the campaign, while operators of 50,000 watt stations were called upon for \$2,500 contributions.

Hytron Adds Electronics

The Hytron Corp., Salem, Mass., has changed the corporate style of the company. Henceforth it is to be known as the Hytron Radio & Electronics Corp. The following officers were elected: Bruce A. Coffin, president and general manager; Lloyd H. Coffin, treasurer and chairman of the Board of Directors; Edgar M. Batchelder, executive vice president; Charles F. Stromeyer, vice president and director of engineering.

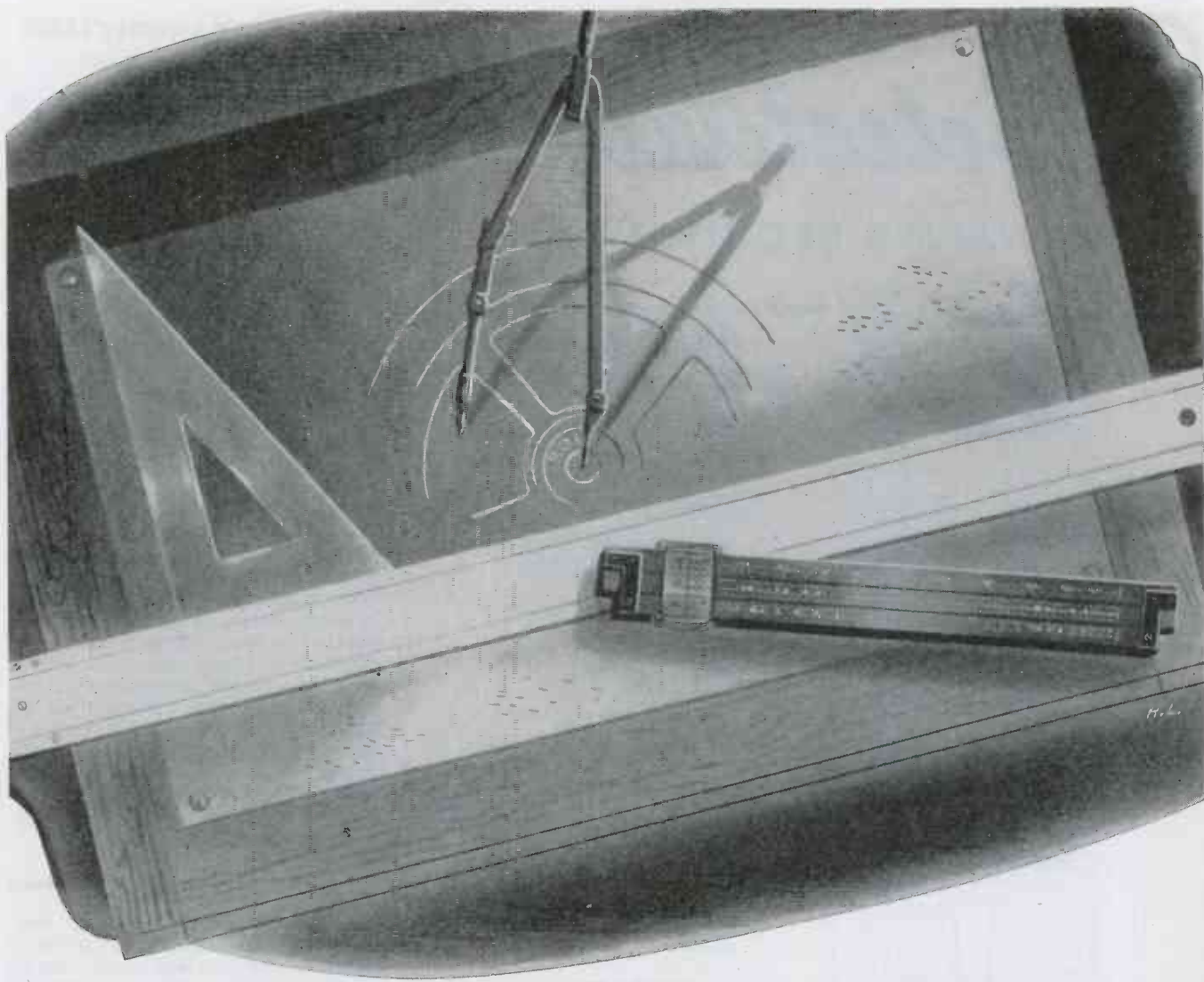

This Blueprint Must Wait

In April, 1942 . . . nearly 3 years ago . . . Rola girded itself for War work and since has confined its Speaker manufacturing to authorized experimental models and needed repairs. From that time, and to meet rising demands for intricate military communications equipment, Rola's facilities have been expanded until now, nearly three times as many people are employed. New machinery has been designed and built and new manufacturing processes have been developed and perfected.

Until wartime obligations are completed all needed manpower and equipment must continue in the production of vital communications components, but after that, Rola firmly intends to keep *all* its employees and *all* its equipment busy. This is a reasonable expectation. The latest developments and discoveries . . . by-products of Rola's

wartime activities . . . are finding application in new Speaker designs, that set new standards of Speaker performance. And beyond this, other things are projected that will enable Rola to serve *more customers*, in *more ways* than ever before.

Specific announcements must wait, but this, in short, is Rola's declaration of policy to its Employees, to former Customers and to the Electronic Industry . . . Rola's blueprint for the future.

THE ROLA COMPANY, INC.
2530 Superior Ave., Cleveland 14, Ohio

ROLA



MAKERS OF THE FINEST IN SOUND REPRODUCING AND ELECTRONIC EQUIPMENT

ELECTRONIC INDUSTRIES • April, 1945

www.americanradiohistory.com

147

Selectivity

FOR VARIED REQUIREMENTS

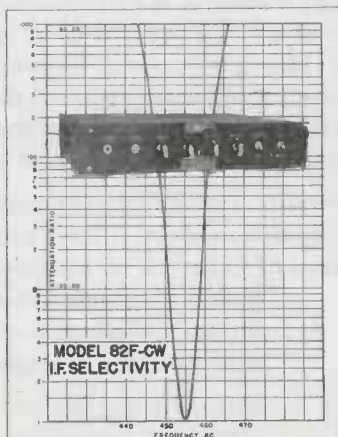
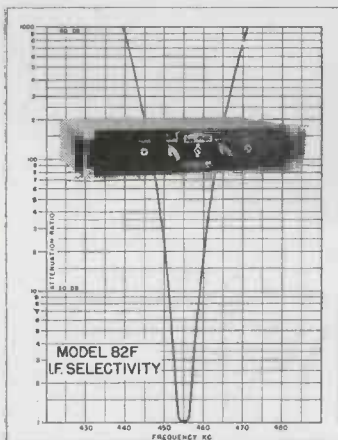
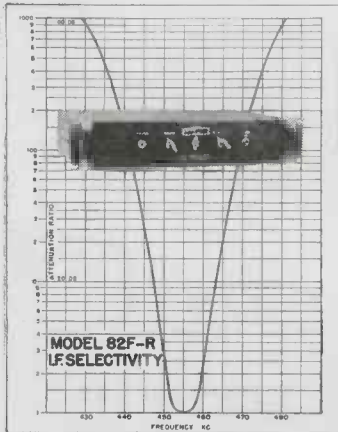

RECEIVERS MODELS 82F-R & 82F

Type:
Fixed Tuned, Crystal Controlled, 3½" Rack Panel Mounting.

Frequency Range:
2.0 to 8.0 Mc.

Image Ratio:
50,000 to 1 (94 db.) at 2.5 Mc.
55,000 to 1 (95 db.) at 3.6 Mc.
45,000 to 1 (93 db.) at 4.8 Mc.
10,000 to 1 (80 db.) at 6.5 Mc.

A.V.C. Action:
Model 82F-R—Constant within 5 db. from 10 microvolts to 1 volt.
Model 82F—Constant within 3 db. from 10 microvolts to 1 volt.

Sensitivity:
3 microvolts 30% modulated for 50 mw. output.

Signal-to-Noise:
Model 82F-R—9 db. at 5 microvolts. Input 30% modulated.
Model 82F—9 db. at 3 microvolts. Input 30% modulated.

Power Source:
110-120 volts, 60 cycles A.C.

Features:
Suitable for local or unattended remote operation. These receivers furnish speaker output for local operation.

RECEIVER MODEL 82F-CW

Type:
Fixed Tuned, Crystal Controlled, 3½" Rack Panel Mounting.

Frequency Range:
2.0 to 8.0 Mc.

Image Ratio:
50,000 to 1 (94 db.) at 2.5 Mc.
55,000 to 1 (95 db.) at 3.6 Mc.
45,000 to 1 (93 db.) at 4.8 Mc.
10,000 to 1 (80 db.) at 6.5 Mc.

A.V.C. Action (Phone):
Constant within 4 db. from 5 microvolts to 1 volt.

A.V.C. Action (CW):
Constant within 2 db. from 5 microvolts to 1 volt.

Sensitivity:
1 microvolt 30% modulated for 50 mw. output.

Signal-to-Noise:
8 db. at 2 microvolts. Input 30% modulated.

Power Source:
110-120 volts, 60 cycles A.C.

Features:
Suitable for local or unattended remote operation. These receivers furnish speaker output for local operation.

OWI-CBS TRANSMITTERS

(Continued from page 85)

tralization adjustment regardless of its operating carrier frequency, within the existing range of 6 to 22 megacycles.

Since power taken from the driver stage appears in the output circuit of an inverted amplifier, any modulating system design must include provisions for modulating the driver in addition to modulating the final amplifier. The degree of modulation is approximately equal for both stages, at any given time.

Both the input circuit and the plate-tank-output circuit of the inverted power amplifier are of the linear line type. That is, as a substitute for the conventional lumped inductance, use is made of a long line resonating frame.

The resonate frame in the power-amplifier-input circuit consists of two copper pipes each approximately three inches in diameter, placed parallel to each other for a linear distance of about ten feet, with a center-to-center separation of approximately twelve inches. This input circuit is resonated for a particular frequency by varying both the effective length of the frame, and by adjusting variable condensers to obtain the proper value of capacitance.

Powered carriage

One of the input tuning condensers is mounted directly on a motor driven carriage which can be made to travel along the length of the frame to a predetermined point, depending on the value of inductance needed for a given frequency. This condenser is of the two section variety with its mid-point grounded, the outer points of the condenser being connected to the frame by means of brush type contactors.

In the illustration of the output circuits of the inverted power amplifier, three linear lines are shown, two of these forming the actual tank inductance and the third comprising the output coupling circuit. The two resonate frames of the plate-tank circuit are arranged so as to be electrically in parallel, the lower frame inductance remaining fixed, while the upper frame can be adjusted for a required value of inductance by varying its effective length.

As with the input circuit, a motor driven carriage travels the length of the upper tank frame and forms a short-circuiting bar which consists of suitable sliding contacts arranged to grip the line. The output-coupling-resonate frame is mounted below the fixed frame of the tank and the degree of inductive coupling can be adjusted by raising or lowering the line by

COMMUNICATIONS COMPANY, Inc.

Manufacturers of Radio and Electronic Equipment

CORAL GABLES COMCO 34, FLORIDA

from  arctic to  tropics



THIS BOND REMAINS PERMANENT

● From the arctic to the tropics—at all altitudes—this permanent hermetic seal of steel and steatite is now successfully protecting all types of communication equipment.

For SEALEX combinations—a new method of joining steatite and metal permanently in various combinations—produces a bond which not only withstands great extremes of temperature, but gives proved protection against vibration, humidity, and Salt Spray Corrosion, as well.

SEALEX Bushings will contain air at 50 pounds per square inch after a thermal change test of 25 cycles from -65°C to $+125^{\circ}\text{C}$. They are available in single terminal and multiple terminal designs for high and low voltage requirements.

For long-life, dependable, trouble-free service, specify SEALEX Combinations. Specifications and complete data on all SEALEX Bushings available for quick delivery are listed in the SEALEX catalog. Send for a copy today. Write us for any special assistance you may require, when confronted with hermetic sealing problems.

SALES REPRESENTATIVES

H. W. GEBHARD
737 No. Michigan Ave., Chicago, Illinois
J. J. PERLMUTH & ASSOCIATES
942 Maple Avenue, Los Angeles, Calif.
MICA COMPANY OF CANADA LTD.
P. O. Box 189. Hull. Quebec

General Ceramics
AND STEATITE CORP.

GENERAL
KEASBEY
NEW JERSEY

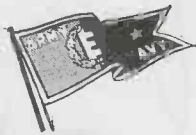

Conant Instrument Rectifiers

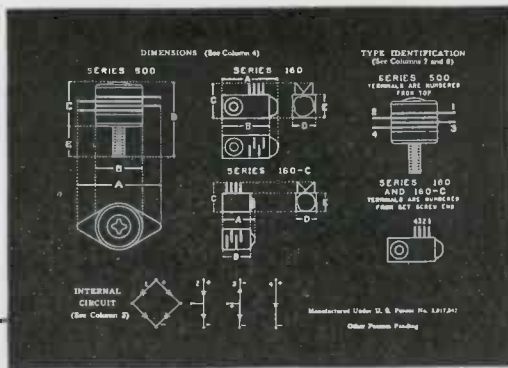

SPECIFICATIONS (STANDARD TYPES)

Col. 1	2	3	4				5	6	7	8			9			10					
Type	Series	Internal Circuit	Dimensions (Inches)				Mounting Screw Size	Weight (Grams)	No. of Terminals	Color, Terminal Number			PEAK ELECTRICAL RATINGS			*List Price					
			A	B	C	D	E		1	2	3	4	Volts	Mils	Volts	Mils	Volts	Mils			
M	500	1	.890	.500	.485	.800	.328	6-32	13,012	4	red	no	blk	no	30	100	20	60	10	30	\$3.50
HS	500	2	.890	.500	.445	.800	.360	6-32	9,158	3	red	no	blk	—	15	100	10	60	5	30	2.70
T	500	3	.890	.500	.445	.800	.360	6-32	9,158	3	no	red	no	—	30	100	20	60	10	30	2.70
H	500	4	.890	.500	.400	.800	.392	6-32	7,730	2	red	no	—	15	100	10	60	5	30	1.50	
B	160	1	.595	.485	.375	.250	.250	2-56	3,400	4	red	no	blk	no	30	15	20	10	10	5	3.50
BHS	160	2	.625	.550	.375	.250	.250	2-56	2,880	3	red	no	blk	—	15	15	10	10	5	5	2.70
BT	160	3	.625	.550	.375	.250	.250	2-56	2,880	3	no	red	no	—	30	15	20	10	10	5	2.70
BH	160	4	.625	.550	.375	.250	.250	2-56	2,700	2	red	no	—	15	15	10	10	5	5	1.50	
B-C	160-C	1	.345	.297	.310	.220	.200	none	1,743	4	red	no	blk	no	30	15	20	10	10	5	3.50
BHS-C	160-C	2	.345	.297	.310	.220	.200	none	1,385	3	red	no	blk	—	15	15	10	10	5	5	2.70
BT-C	160-C	3	.345	.297	.310	.220	.200	none	1,385	3	no	red	no	—	30	15	20	10	10	5	2.70
BH-C	160-C	4	.345	.297	.310	.220	.200	none	1,293	2	red	no	—	15	15	10	10	5	6	1.50	

Over ninety per cent of all rectifier requirements are served by 12 types—4 basic assemblies in 3 series. These 3 series are the three primary units of Conant rectifiers. Special types, however, can be developed as needed, and you'll find Conant ready to cooperate.

SERIES 500 UNITS are for general applications requiring greater output current for meters, relays or other apparatus requiring more than 1 milliamper. Recommended for all such applications at commercial and the lower audio frequencies. Will also operate up to 50,000 c.p.s. in special applications wherein accuracy of readings is not essential.

SERIES 160 and 160-C are for applications requiring good frequency response over the entire commercial and audio range and especially when the meter, relay or other apparatus requires less than 1 milliamper for operation. In some special applications these units may be operated at frequencies up to 15,000,000 c.p.s. with special circuit treatment.

SPECIAL TYPES are available in both series 500 and 160-C. When requesting a quotation on a special type include a sketch of the rectifier required or a circuit diagram showing source and frequency of the input voltage, resistance and kind of load, required load current and the ambient temperatures.

SERIES 500 Disc diameter .500 inch. Area each disc .15 square inch. Furnished with 3" braided, tinned copper leads. Finished in clear lacquer. Nickel plated end plates.

SERIES 160 Disc diameter .160 inch. Area each disc .02 square inch. Furnished with 3" stranded, tinned double silk covered copper leads. Nickel plated case. Assembly sealed with specially developed moisture proof compound.

SERIES 160-C Disc diameter .160 inch. Disc area, lead wire and length and moisture proof seal are identical with Series 160. Dimensions of the nickel plated case have been reduced to the most compact size. These units may be mounted in a standard midget fuse clip.

Conant Instrument Rectifiers are available from leading radio jobbers everywhere—consult your local jobber.



Instrument Rectifiers

ELECTRICAL LABORATORIES

6500 O STREET, LINCOLN 5, NEBRASKA, U. S. A.

20 Vesey St., New York 7, New York
85 E. Gay St., Columbus, Ohio
600 S. Michigan Ave., Chicago 5, Ill.
1215 Harmon Pl., Minneapolis 3, Minn.

2017 Grand Ave., Kansas City, Mo.
7935 Euclid St., Dallas 18, Texas
4018 Greer Ave., St. Louis, Mo.
1526 Ivy St., Denver, Colo.

4214 Country Club Dr., Long Beach 7, Cal.
4205 N.E. 22nd Ave., Portland 11, Ore.
Caixa Postal 930, Sao Paulo, Brazil
50 Yarmouth Rd., Toronto, Canada

means of a motor driven lead screw.

A fixed portion of the tank circuit was included as a part of the design so as to provide a constant length of active plate frame, regardless of operating frequency. Therefore, complexities which result from the problem of being able to transfer power to an output circuit from a plate tank, the inductance of which must be adjustable over a range corresponding to a frequency spread of 6 to 22 megacycles are minimized.

The resonate plate frames carry the water to and from the water cooled tube sockets of the final amplifier, the lines being mounted directly on the jackets. Conventional ceramic water coils are located at the opposite ends of each frame line, and serve to isolate the dc plate voltage from the water cooling system.

Adjustment procedure

The carrier frequency of the final amplifier can be rapidly and easily adjusted for operation on any of the frequencies within the international bands. All of the tuning is performed from the front panel of the 200 kw final amplifier, and includes controls for operating the motor driven carriages of the resonate frame lines and the motor operated output coupling.

An input audio source for the modulating system can be obtained from either of two incoming telephone lines, or from electrical transcription turntables in the transmitter building. These audio signals are routed through the rack-contained input amplifiers and control console, providing supervisory facilities for the operating personnel. Included as part of each audio channel is a conventional limiting amplifier, as well as a peak chopper designed to have an extremely rapid attack time. The rapid action excludes the possibility of transmitter outages caused by an incoming audio signal of excessive magnitude which is not suppressed by the limiter amplifier.

From the control console the audio-frequency energy is fed to the transmitter modulator units. The modulator proper consists of six type F-125 water-cooled tubes operated in Class B, push-pull parallel. It is capable of delivering an output of 150 kw of audio power, and is applied to both the rf power amplifier and rf driver stages through a suitable system of modulation transformers and reactors.

Individual water circulating and cooling systems are provided for the tubes in the modulators and the rf power amplifiers of each transmitter. In addition to the regular complement which forms one complete cooling system, dupli-



● Its *bend-ability* and high arc resistance, suggested the use of National Vulcanized Fibre in the manufacture of this arc baffle used in an electric circuit breaker.

It Bends..

Tough Production Problems Made Easy by this Remarkable Property of National Vulcanized Fibre

Just as the amazing bending properties of National Vulcanized Fibre suggested its use and simplified the production of this arc baffle—so will its combination of outstanding characteristics make it readily adaptable for the manufacture of countless other industrial products.

Its superior machinability and forming qualities, its toughness and high

dielectric strength, its resistance to wear and abrasion, its lightness of weight and its long-lasting durability . . . all combine to make this material highly versatile and suitable for an almost endless number of industrial uses. If desired, these same properties may be modified to meet requirements of your specific applications.

Right now our entire output is being

used for vital war purposes. But our technical engineers will be glad to work with you and show you how this versatile material will help you overcome tough production problems in peacetime . . . how it may open up entirely new fields for profitable products for you. Write us *now*. Let a trained technical man show you how National Vulcanized Fibre will help you *later on*.

NATIONAL VULCANIZED FIBRE CO.

Wilmington, Delaware

Offices in Principal Cities



Memo to *Design Engineers* -

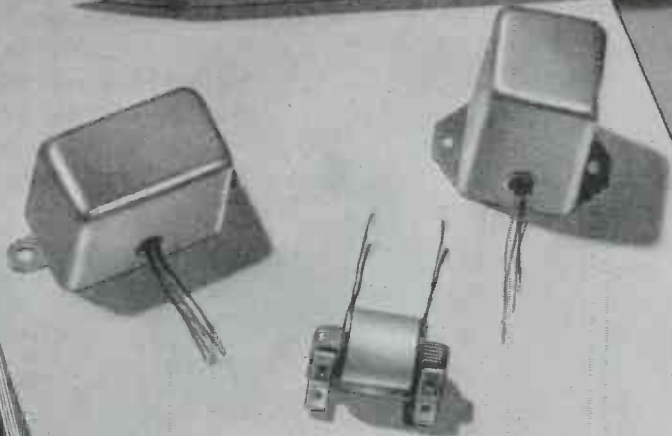

PERMOFLUX

Now--"World's Smallest Transformers" Can be Produced to Meet Your Own Exacting Design Requirements

One of these new Permoflux midget transformer types may be the complete answer to your space or weight problem. Available unshielded, shielded or hermetically sealed, they provide exceptional operating efficiency and uniform frequency response.

The same Permoflux engineers who developed these transformers, using new materials and manufacturing methods, are ready to assist in designing a unit for you. Write for technical catalog listing transformers, speakers, headphones and other Permoflux acoustical products.

BUY WAR BONDS FOR VICTORY!

TRADE MARK
PERMOFLUX

PERMOFLUX CORPORATION
4900 WEST GRAND AVE., CHICAGO 39, ILL.

PIONEER MANUFACTURERS OF PERMANENT MAGNET DYNAMIC TRANSDUCERS

cate units are available. Approximately 12,000 gallons of water per day are re-circulated through the system, enough to dissipate 1,260,000 BTU's per hour. Each transmitter cubical is ventilated by air delivered via a system of ducts originating in the cooler room.

A dc rectifier unit, employing twelve mercury vapor type F-357 vacuum tubes, serves as a source of plate input power for both the rf power amplifier and the modulator. It is capable of delivering 600 kw of direct current at 12,000 volts.

Complete protection is provided for the operating personnel against possible injury and an intricate system of control and overload protective circuits is a part of each transmitter. A unique protective circuit incorporated as part of the transmitter is a system of automatic carrier cut-off. This system affords protection not obtainable from a normal complement of overload relays. Faults such as unbalanced transmission lines, an open antenna switch, or low power output will operate the carrier cut-off system. In the event any one of these faults occurs, the carrier cut-off circuit will instantly squelch the rf output and, in addition, remove the audio input being fed to the modulator unit. Its operation is based on taking a sample of rf from the power amplifier transmission line, rectifying it and applying the direct current to a balanced circuit containing various relays. The unbalance of this circuit results in the operation of the relays which, in turn, applies excessively high bias to the rf drive, reducing its output to zero and, at the same time, the relays short the audio input circuit.

Antenna arrangement

The antennas are arranged in groups, for use on a given bearing or direction of transmission, each group containing three different size rhombics. These various sizes were determined for optimum operating frequencies of 9.6, 11.8 and 15.3 mc. They are mounted 1.5 wavelengths above ground, having a leg length of 4 wavelengths, and a tilt angle of 70 deg. At their design frequencies they possess the following characteristics: vertical angle of maximum radiation, 10 deg.; beam width at the 6-db points (point of one half field intensity as taken from the maximum) 20 deg.; approximate signal gain, referred to a halfwave dipole in free space, is equal to 11 db.

All antennas are operated as terminated rhombics. The termination network consists of a high resistance transmission line capable of dissipating the required power. A terminated rhombic is exceptionally versatile from an operation standpoint in that it is relatively non-

Six good reasons...

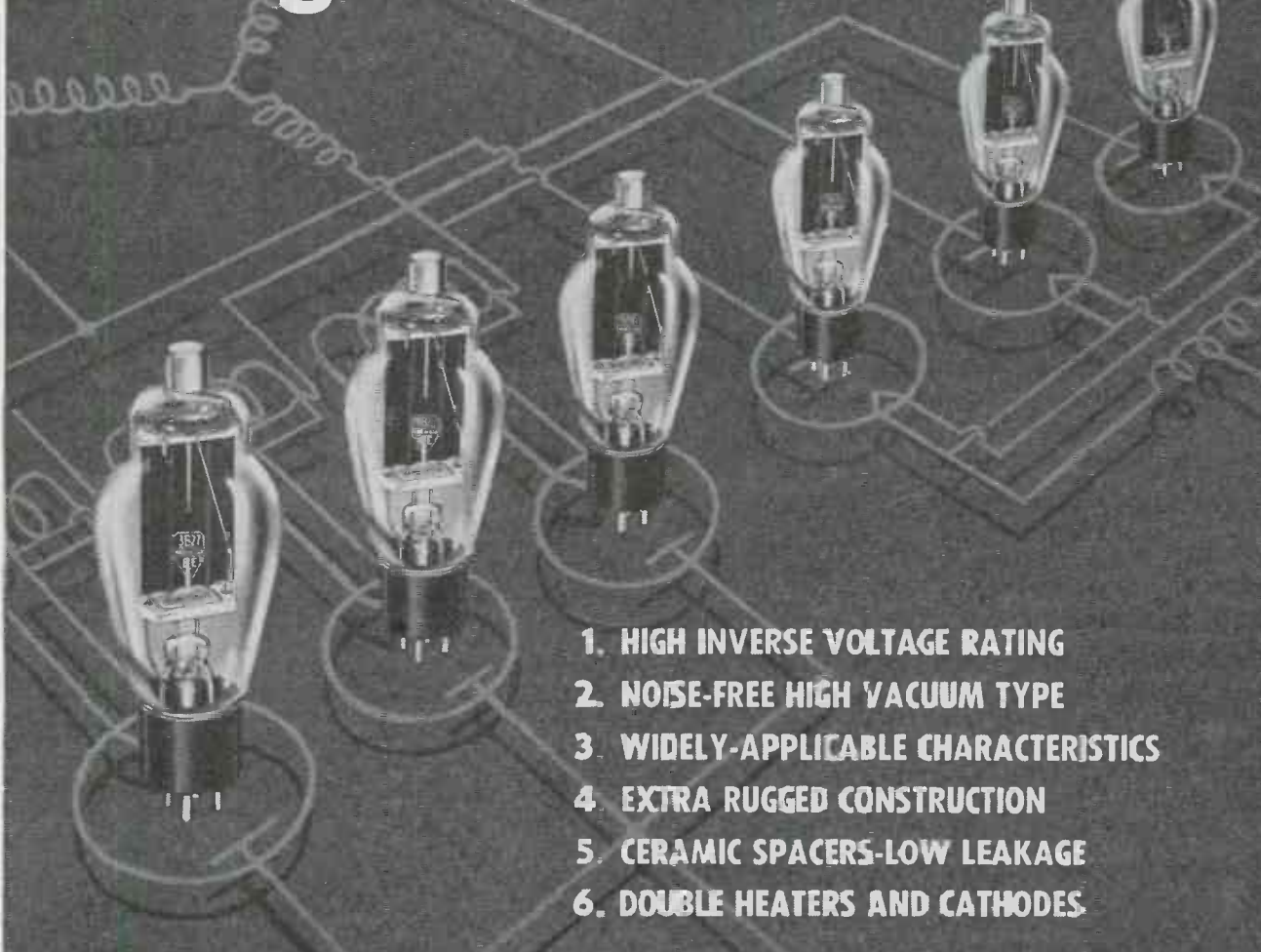

1. HIGH INVERSE VOLTAGE RATING
2. NOISE-FREE HIGH VACUUM TYPE
3. WIDELY-APPLICABLE CHARACTERISTICS
4. EXTRA RUGGED CONSTRUCTION
5. CERAMIC SPACERS-LOW LEAKAGE
6. DOUBLE HEATERS AND CATHODES

...for BETTER rectifier performance!

The diversified E-E line of rectifiers—high vacuum, mercury vapor and grid control types—offer complete suitability for all industrial and communication requirements. All incorporate exclusive mechanical and electrical features that assure the extra dependability customarily associated with E-E engineering.

For example, the E-E 3B27, half-wave high vacuum rectifier typifies this performance-plus factor inherent in E-E tube designs. Suitable for single or multi-phase operation at high voltage this tube handles peak plate currents to 0.6 amps. at peak

inverse voltages to 8,500 or plate currents to 1.0 amps. peak at 600C volts peak inverse voltage. It is ruggedly constructed for industrial or portable use, and is quiet in operation for communication application. Ceramic spacer minimizes leakage and double heater and cathodes are provided for long, dependable service life.

WRITE FOR DATA BOOK

This 30 page compilation of electronic vacuum tube types, characteristics and operational information, will be sent on request on company letterhead. An important, concise addition to technical libraries in all phases of industry.

ELECTRONIC ENTERPRISES, INC.



GENERAL OFFICES: 65-67 SEVENCH AVENUE, NEWARK 4, N. J.

EXPORT DEPT. 25 WARRREN STREET, NEW YORK CITY, N. Y.

An ANDREW SOLUTION to an ANTENNA PROBLEM

 Faced with a difficult antenna problem, E. H. Andresen, Chief Engineer of Chicago's Board of Education Station WBEZ, called on ANDREW engineers for a solution. The problem was that of coupling a 70-ohm unbalanced coaxial transmission line to the much smaller balanced impedance of the antenna. Uncertainty of the exact value of the antenna impedance made the problem difficult, and called for some kind of an adjustable coupling device.

ANDREW solved the problem by constructing a quarter wave impedance transforming section with a concentric "bazooka" for the balance conversion. Adjustments were made by varying the average dielectric constant in resonant section.

This problem is but one of many that the experienced staff of ANDREW engineers are called upon to solve. As qualified experts in the field of FM, radio and television antenna equipment ANDREW engineers have solved many problems for military and broadcast engineers.

FOR THE SOLUTION OF YOUR ANTENNA PROBLEMS
 . . . FOR THE DESIGNING, ENGINEERING, AND BUILDING OF ANTENNA EQUIPMENT . . . CONSULT ANDREW

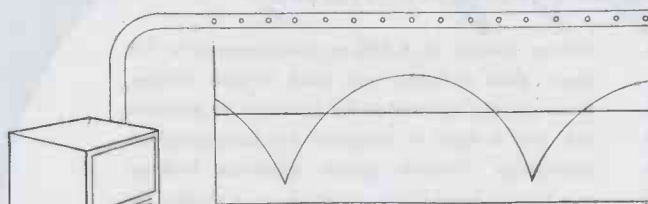

• Curve shows standing waves determined by probing electrostatic field in "piccolo" (section of transmission line with holes drilled in outer conductor). Wavy curve represents initial conditions before adjustment; straight line shows the final result after adjustment of matching unit.

ANDREW CO.



363 East 75th Street, Chicago 19, Illinois



• Twin-barreled dehydrating unit especially designed for WBEZ by ANDREW engineers. Design permits leaving one cartridge in service while the other cartridge is being recharged.

frequency sensitive and can be efficiently operated over a reasonable range of frequencies without requiring any adjustments or re-tuning.

This is an important point, as throughout the daily periods of transmissions it is necessary to change periodically the carrier frequency of each international transmitter in accordance with changing ionosphere characteristics. The advantage of being able to operate the Delano antennas over a wide range of frequencies without adjustment is gained by accepting a certain loss of power in the termination network. However, irrespective of this loss, gains obtained are considerable, ranging from 10 to 13 db depending on the operating frequency. Therefore, as viewed from the advantages to be realized over that of employing a half-wave dipole, a 200-kw carrier fed into one of the Delano rhombics radiates a power equivalent to approximately 4000 kw in the desired direction of transmission.

Antenna selection

The problem of being able to select any of the various antennas for operation with any of the existing transmitters becomes exceptionally difficult when it is required to switch transmission lines which must carry 200 kw of radio-frequency energy. Peaks approaching 28,000 volts of rf are present on the lines when the transmitter is modulated 100 per cent. Although the antennas are not switched under power, any design chosen for the antenna switching system must include provisions for proper insulation of these high rf voltages as well as for the large values of transmission line current. In addition, precautions must be taken to exclude any abrupt changes in the transmission line configuration as it is routed through the switching system. The existence of such irregularities will cause transmission line impedance discontinuities which, in turn, can result in a high standing wave ratio.

The antenna switching system at Delano is located in the open a short distance from the transmitter building. The basic components associated with a given transmitter output consist of a transmission line mounted on a boom, which can be moved in a horizontal arc. Transmission lines from the various antennas are routed to the antenna switching bay and are mounted along an arc corresponding to the same radius as that of the boom.

To select a given antenna the transmitter output boom is moved along its arc until it coincides with the desired antenna's transmission line. A switch provides the necessary connection. Three booms are

20
30

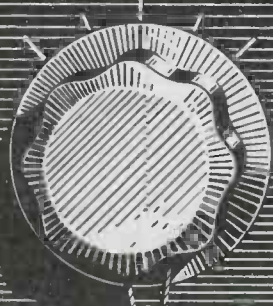

This equipment is designed to operate at
115 V-AC
60 cycles

As a protection against voltage fluctuations a **CONSTANT VOLTAGE TRANSFORMER** has been built-in as a component part of this equipment. Rated performance will therefore be maintained at all times, regardless of input voltage fluctuations as great as $\pm 15\%$.

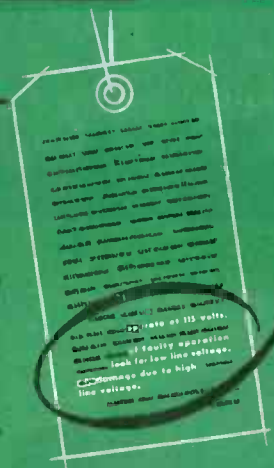

... operate at 115 volts.
... of faulty operation
look for low line voltage.
... damage due to high
line voltage.

Isn't that asking a lot of several million people who wouldn't know how to look for low voltage, or what to do about it if they found it?

Warnings against unstable voltages are unnecessary on equipment protected with built-in **CONSTANT VOLTAGE**

Unstable voltage on commercial power lines is so prevalent that many manufacturers of electrical and electronic equipment have found it necessary to warn their customers of its existence and its possible effects on the operation and efficiency of the equipment.

There is an easy and inexpensive solution to this important problem—specify a **SOLA CONSTANT VOLTAGE TRANSFORMER** as a component

part of your equipment. There are several types of **SOLA CONSTANT VOLTAGE TRANSFORMERS** specially designed for this purpose—small, compact units in capacities ranging from 10VA to several KVA. Other capacities and designs can be custom built to your specifications.

Once installed in your equipment they require no pampering or supervision. They are fully automatic, instantly correcting voltage fluctua-

tions as great as $\pm 15\%$. They are self-protecting against short circuit.

No sales manager will overlook the added salability of a product that features this guarantee of performance, low maintenance cost and satisfaction to the user.

SOLA engineers with wide experience in the application of the **SOLA CONSTANT VOLTAGE** principle are available for consultation on details of design specifications.

Constant Voltage Transformers **SOLA**

To Design Engineers:
Complete, new hand-book of Constant Voltage Transformers available on request.
Ask for Bulletin 10CV-102

Transformers for: Constant Voltage • Cold Cathode Lighting • Mercury Lamps • Series Lighting • Fluorescent Lighting • X-Ray Equipment • Luminous Tube Signs • Oil Burner Ignition • Radio • Power • Controls • Signal Systems • Door Bells and Chimes • etc. **SOLA ELECTRIC CO., 2525 Clybourn Ave., Chicago 14, Ill.**

SHEET METAL FABRICATION



"Cole Steel Equipment" specializes in tough sheet metal assignments as well as boxes, chassis, and instrument housings. Whether your blueprints call for extreme precision or gauge limits, we're geared to design, fabricate and finish exactly to specifications. Whatever your problem, let us help you.

COLE STEEL OFFICE EQUIPMENT

will again be available
after the war

COLE

STEEL EQUIPMENT COMPANY

349 Broadway, New York 13, New York • Factory: Brooklyn, New York

used. The individual booms are mounted at various levels in a vertical plane and can be operated independently for the selection of any given antenna.

This antenna switching bay presents an impressive sight, being constructed of timber approximately 20 ft. high, which forms the antenna transmission line termination arc in a radius of about 25 ft. The transmitter output booms can be rotated by the operating personnel from a catwalk constructed around the circumference of this unit at a height of 10 ft.

Beam shifting

A manually - operated switch changes the beam direction of a given antenna so as to fire on either Latin America or the Far East. These are located below the center point of their associated antennas and are designed so that in operation they transfer the transmission line feed from one vertex of the rhombus to the opposite vertex. The dissipation network is transferred in a similar manner by the same operation.

Like any project conceived to further the war effort, the final completion of the Delano plant is actually only the beginning. Its real value will be judged by its continued successful operation in providing broadcast reception in the vast reaches of the Pacific and Latin America. The OWI-CBS west coast short-wave transmitting plant has now been successfully operated on a regular schedule of transmissions for a period of four months.

Programs emanating from the OWI studios in San Francisco are beamed on sectors of the Far East. Also, from San Francisco programs are originated by the Coordinator of Inter-American Affairs, which are transmitted by antennas centered on sectors of Latin America. In addition to foreign language programs, entertainment is broadcast by the Armed Forces Radio Services to men of the United States Armed Forces stationed throughout the world, and includes the retransmission of popular programs carried by the major networks in this country.

Insulating Compounds

"Insulating Varnishes and Compounds" is an informative 56 page booklet containing many helpful tables, charts and articles compiled for the purpose of providing a worthwhile approach to any insulating varnish problem. It is a handy, ready reference for many problems, such as the selection of insulating varnishes and compounds, thinning of insulating varnishes, etc. Publisher is John C. Dolph Co., Newark, N. J.

"WS" AND "WSB" FILAMENT TRANSFORMERS

ELIMINATE EXPOSED SECONDARY LEADS!

Simplify your rectifier circuit by installing AmerTran "WS" or "WSB" filament transformers. These ingenious two-in-one units incorporate the tube socket in the transformer body and in the "WSB", the center tap is brought out through the ceramic base. Thus, they eliminate filament wiring and save copper, promote safety, reduce maintenance and cut costs.

Because of their inherent ruggedness, these transformers are being used in ratings formerly restricted to oil-immersed apparatus. Both AmerTran "WS" and "WSB" transformers are moisture-proofed and insulated well above the average. Their test voltage is two and a half times their rated d.c. operating voltage.

Primary taps are arranged to permit close control of secondary voltage. Other features include completely enclosed windings, compound filled and full electrostatic shields. Send for Bulletin No. 14-5.

AMERICAN TRANSFORMER COMPANY, 178 Emmet St., Newark 5, N. J.

AMERTRAN PRODUCTS

MODULATION TRANSFORMERS AUDIO FREQUENCY TRANSFORMERS

HERMETICALLY SEALED TRANSFORMERS

TRANSTAT A.C. VOLTAGE REGULATORS

HIGH VOLTAGE RECTIFIERS WAVE FILTERS

OTHER ELECTRONIC AND INDUSTRIAL TRANSFORMERS

AMERTRAN

MANUFACTURING SINCE 1901 AT NEWARK, N. J.

Pioneer Manufacturers of Transformers, Reactors and
Rectifiers for Electronics and Power Transmission



MOTOR DATA

No. 126



2300 FRAME MOTOR 1/5 HP at 3800 RPM

The basic design of the 2300 Frame Motor has been used in scores of individual modifications. Many of these designs are complete and available—others for new equipment can readily be developed.

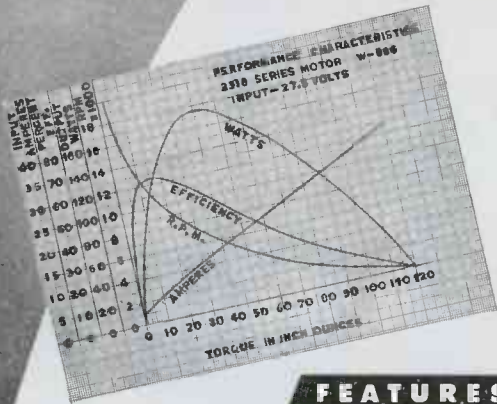

FEATURES

ELECTRICAL

- Series or shunt wound
- High starting torque
- Low starting current
- High efficiency
- Low RF interference
- Unidirectional or reversible
- Armature and field windings varnish impregnated and baked

MECHANICAL

- Low weight factor
- Unusual compactness
- Completely enclosed
- Base or flange mounting
- Laminated field poles
- Precision ball bearings
- Segment-built commutator
- Permanent end play adjustment

2300 FRAME MOTORS		2318 Series	2310 Shunt
Watts Output, Int.	(max.)	160	50
Torque at 6000 RPM	(in. oz.)	40	10
Torque at 3800 RPM	(in. oz.)	57	—
Lock Torque	(in. oz.)	120	14
Volts Input	(min.)	5	5
Volts Input	(max.)	110	28
Temperature Rise	(int.)	50°C	50°C
Diameter		2 ⁵ / ₁₆ "	2 ⁵ / ₁₆ "
Length less shaft		4 ⁵ / ₃₂ "	2 ³ / ₄ "
Shaft Dia.	(max.)	.312"	.312"
Weight	(lbs.)	2.4	1.5

RECORDING ON FILM

(Continued from page 93)

various functions required in field use, a 114 db gain amplifier is used. The frequency response of typical model from stock is shown. Since for some uses a lower gain is needed, the various input circuits are arranged to automatically select the gain required for the intended uses. For example, a high impedance microphone (1/2 megohm) requires high gain, while the input from a radio receiver for recording or public address system uses, needs a low gain. This gain is selected by making connection to the proper amplifier stage. Impedance matching is also handled at the same time. For a telephone line input, 1000 ohms ac impedance (dc impedance, infinity) conditions is selected. For use with a 100 or 200 ohm carbon microphone, self-contained batteries are connected in.

Various outputs

Likewise a variety of output circuits can be selected at will: A self-contained 5-in. PM speaker, a 6-ohm phone jack which disconnects the signal to the speaker (when used), or a direct connection from the playback head for monitoring purposes. A volume indicating meter is provided for easy adjustment to correct recording level. This is not ordinarily a problem since AVC can be switched in to accommodate a 30 db input signal variation. The overall frequency response (recording input to playback output) is 150 to 3500 cycles on the standard model running at 60 ft. per minute, although 5000 cycle machines have been produced to order.

In many types of recording as in combat duties, as recorders of radio communications or for keeping track of verbal orders it is necessary to frequently start and stop the film in order to avoid long stretches of unused track. To handle this problem either manual or automatic control of the machine running time may be selected at will. The device for starting and stopping, called the Audiotrol, utilizes the voice or sound signal to "trigger off" the starting clutch. To do this the output of the amplifier operates a thyratron tube (type 2050) which in turn energizes the clutch relay. Delay time to start is 1/10 second and the hold-over time (the interval that the machine runs after the voice stops) is from 4 to 6 seconds. At the start the loss of sound is negligible, a single syllable at the most, and a complete record at the end is attained without requiring that a continuous stream of words be picked up just to keep the machine running.

The monitoring method selected

EICOR INC. 1501 W. Congress St., Chicago, U.S.A.

DYNAMOTORS • D. C. MOTORS • POWER PLANTS • CONVERTERS

Export: Ad Auriema, 89 Broad St., New York, U.S.A. Cable: Auriema, New York

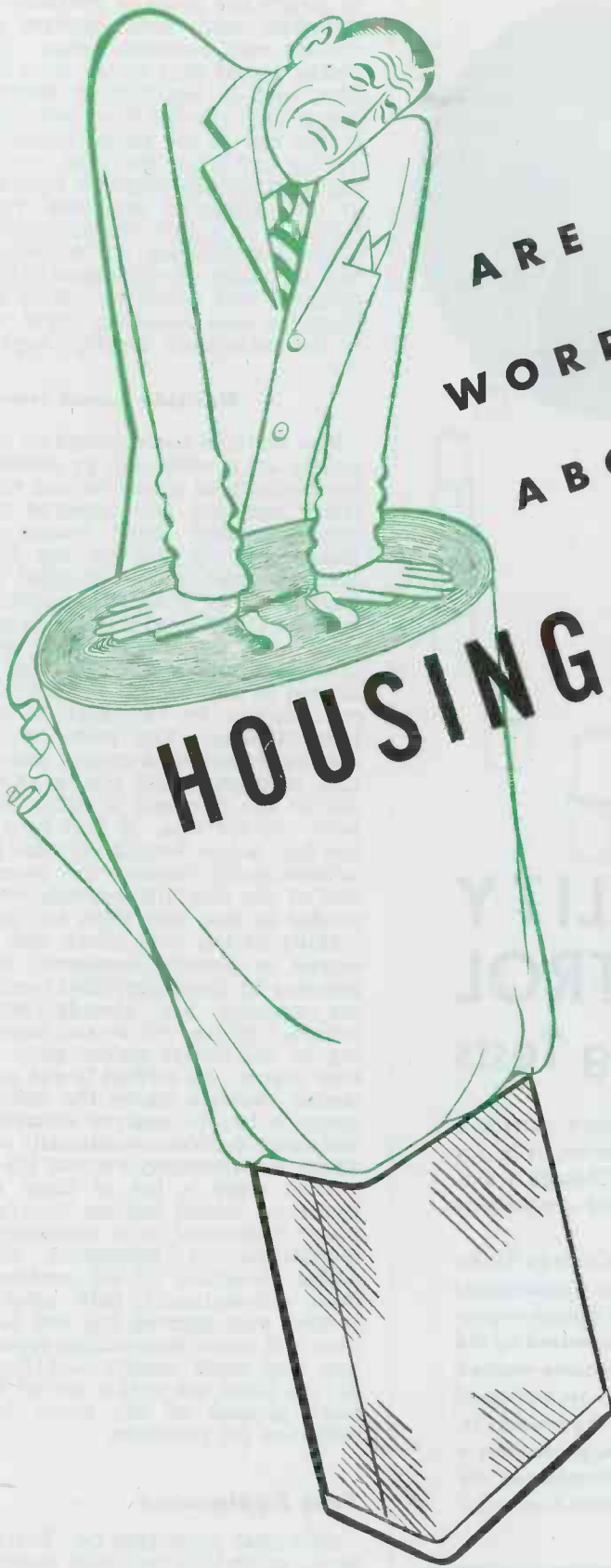

ARE YOU
WORRIED
ABOUT THE
HOUSING PROBLEM?

**Schweitzer has solved
it with .00025"**

Schweitzer Paper Company, one of the largest producers of condenser papers, sensed the need of a condenser paper thin enough for use in the small housings necessary for war and post-war equipment. Experiment, based on experience, enabled them to create a paper gauged to .00025"...with a tolerance of + or - .000025". Perhaps tiny housings are not your problem...but whatever your problem may be, if it has to do with paper for condensers, coils, transformers, or other insulation purposes...you can solve it with Schweitzer.

SCHWEITZER PAPER CO.
142 MILLER STREET • NEWARK, N. J.
Plants: Newark, Jersey City, Mt. Holly Springs, Pa.
Research Laboratories: Chrysler Bldg., New York, N. Y.

SPECIALISTS IN THIN GAUGE INSULATING PAPERS



QUALITY CONTROL

The Bushing Tests

The maintenance of uniformity and accuracy in component parts is a recognized prerequisite of quality in a finished transformer, as in any precision product. For this reason, important parts of Chicago Transformers are closely inspected and tested for structural and dimensional accuracy before they reach production.

Ceramic bushings, a vital part of Hermetically-Sealed Chicago Transformers, are subjected to exhaustive tests and inspections. Dimensional accuracy to close tolerances is insured by micrometer and gauge inspection, while internal flaws and structural imperfections are detected by the use of light directed through bushing walls and by air-pressure exerted upon each bushing under water. As a final check the bushings are subjected to a high-voltage breakdown test to determine their insulating properties.

By this type of close control of quality in essential parts, production is facilitated and high standards of quality in the finished transformer are maintained. The result—better service to Chicago Transformer customers.

CHICAGO TRANSFORMER

DIVISION OF ESSEX WIRE CORPORATION

3501 WEST ADDISON STREET
CHICAGO, 18



to satisfy the needs of professional recording men, uses separate recording and playback heads. The pickup signal thus comes from the film, and is not tapped directly across the recording head, providing a true test of the actual recording quality and level. Both the recording head and the playback head are of the balanced magnetic type, sealed against dirt. The former has 6 ohms impedance at 1000 cycles and the latter an impedance of 9000 ohms at this frequency. Both the playback and recording styli are of the permanent sapphire type.

Multiple sound tracks

The features incorporated in this system are possible only by combining mechanical precision and electronic agencies. One hundred and fifteen parallel sound tracks are placed side by side on the film, each of which can be selected instantly by an automatic indexing system. The film always starts and stops at a selected point at each turn, and a playback can thus be started at any wanted point in the conversation by reference to the indexed data. The ends of the film are joined by a special process that is as physically strong as the rest of the film and is still a butt joint—no overlaps. A half turn in the film before joining provides for automatically turning the reverse side of the film into position when needed so that both sides are used.

Many of the uses which will be served in postwar commerce and industry by these simplified recording systems are already being proved. One use will be the recording of all verbal orders given in busy places. An airfield is one particular example where the control operator has to analyze situations and make decisions continually and where the necessary clerical job of writing down a log of these instructions makes tedious interruptions. Illustrated is a commercial installation of equipment that makes recording of all conversations automatically, both sides if desired with nothing left out. Lecture and court proceedings reporting, long news reports and books for the blind are only a few of the more popular of the many uses projected for recorders.

Test Equipment

Technical Apparatus Co., Boston, Mass., as its title indicates, specializes in the production, from the plans of customers or from its own, of test equipment and has just issued a 10-page catalog listing several items of the kind. They include a high voltage, low current power supply, several types of tube testers, a capacitor tester, a 400 cycle generator and other instruments useful in factory operations.

Electronics-

HAS BEEN LARGELY HUSH-HUSH



but this is no secret about Aluminum

IT HAD TO BE LIGHT

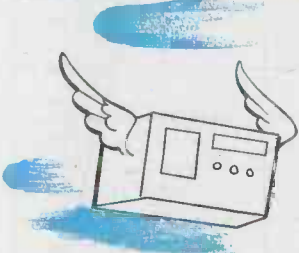

IT HAD TO BE RUGGED

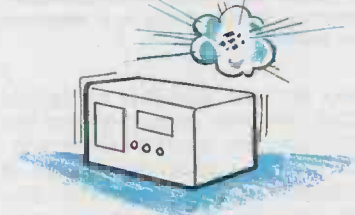

IT HAD TO BE CORROSION-RESISTANT

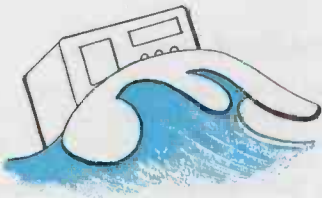

Much of the wartime electronic equipment has to fly. This necessarily means light weight, and, naturally, Alcoa Aluminum Alloys. Whether toted on a soldier's back, in a plane or tank, or behind the big guns of a battleship, it has to withstand severe shock. This requires sturdiness, a property readily built in with aluminum.

Electronic equipment goes ashore with landing parties, through steaming swamps and deep into jungles. Certainly no spot for a sissy. The normal corrosion-resistance of aluminum and the protective coatings that can be added to it, keep this apparatus on the job.

Alcoa engineers will gladly help in postwar employment of Alcoa Aluminum Alloys. Write ALUMINUM COMPANY OF AMERICA, 1921 Gulf Building, Pittsburgh 19, Pennsylvania.

ALCOA FIRST IN ALUMINUM



FOR POST WAR REQUIREMENTS

40 YEARS OF EXPERIENCE AT YOUR SERVICE

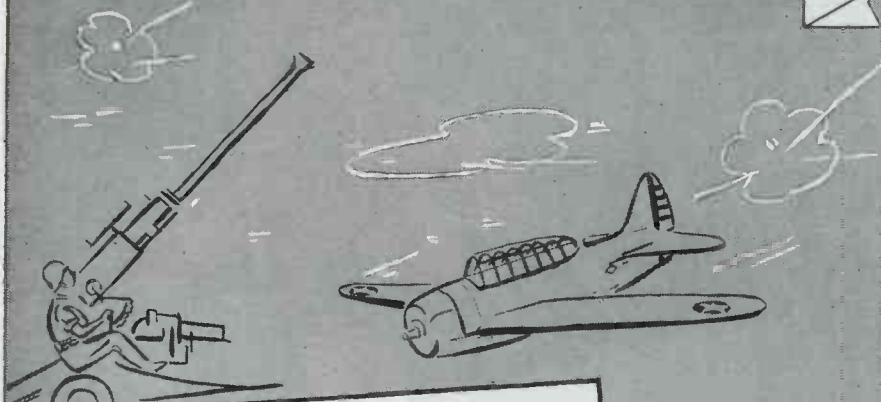

Willor Makes It!

... and makes it with a high degree of precision and cooperation born of our concentrated experience in meeting wartime's rigid requirements and schedules. From raw stock to completed items ... Willor service embraces every facility for planned production.

We Invite Inquiries and Blueprints

- METAL STAMPINGS
- MACHINE WORK
- LAMINATIONS
- TOOLS AND DIES
- PANEL BOARDS
- PLASTIC PARTS
- MECHANICAL AND ELEC. TRICAL INSTRUMENTS

WILLOR
MANUFACTURING CORP.

288 Eastern Blvd., New York (54), N. Y.

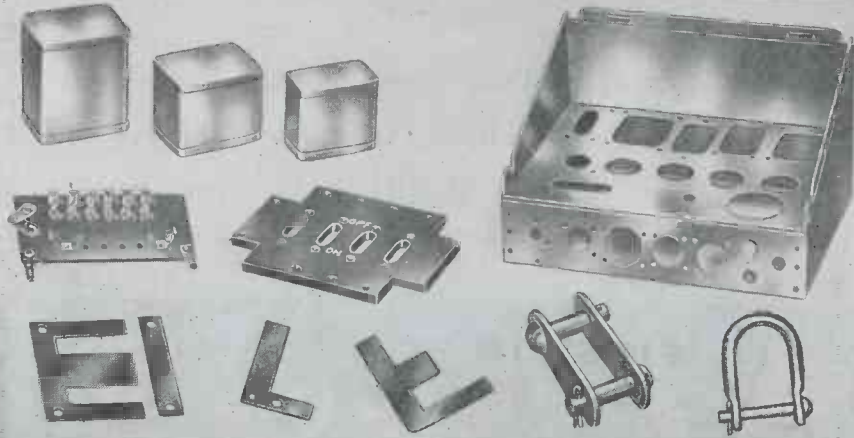
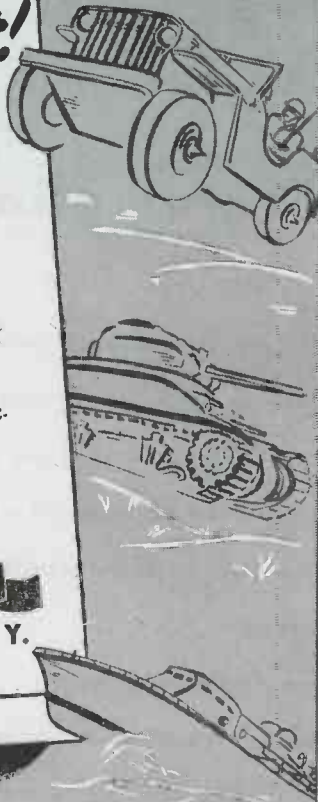

BACK THE ATTACK -- BUY MORE WAR BONDS

CAVITY RESONATORS

(Continued from page 105)

pacitor is governed by the equation

$$C\omega v_c / \delta I_c = \frac{1}{\frac{Z_1^2 + R^2}{R} + \frac{Z_a}{N_0(Z_a)}} \times \left[\frac{1}{J_1(Z_a) - \frac{J_0(Z_a)}{N_0(Z_a)} N_1(Z_a)} \right] \times \frac{1}{\left[\frac{N_1(Z_1)}{Z_1(Z_1)} \frac{N_0(Z_1)}{Z_0(Z_1)} \right] - 2}$$

Figure 11 represents the corresponding curves.

Intermediate shapes

In practice resonator shapes which are neither elongated nor

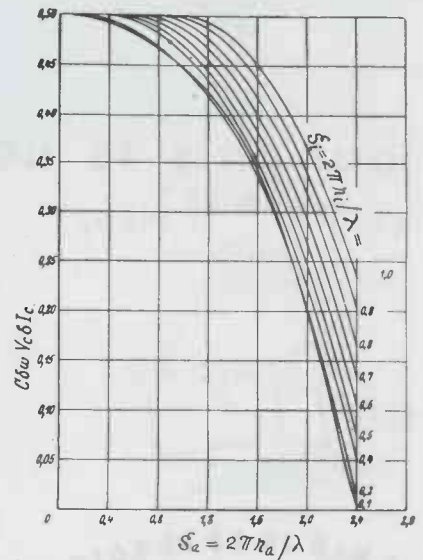

Fig. 11—Graph illustrating wavelength-modulating electron stream relation in a magnetron with flat resonator

flat may be used, and it is explained that the two sets of curves for the extreme shapes permit interpolation to find the desired features of intermediate shapes. Numerical examples for this interpolation procedure are given.

¹N. Morgulis and A. Nagorsky, J. Tech. Phys. U.S.S.R. 5, 848 (1938).

Specialized Products

What amounts to a personally conducted tour through the extensive plants of Lear, Inc., which has headquarters in Piqua, Ohio, and plants there and in Grand Rapids, Mich., and Los Angeles, is contained in a 24-page brochure that has just been issued. Included are illustrated descriptions of many Lear products for aviation, radio, electronic and other purposes. Particularly interesting are the many engineering problems presented to the company and the solutions which appear with them.

BH EXTRA FLEXIBLE FIBERGLAS SLEEVING



MAKE THIS

FLAME TEST



Hold a match under a piece of BH Extra Flexible Fiberglas Sleeveing. The flame does not burn, char or otherwise affect it. And temperatures much higher than usually encountered electrically are just as readily resisted by the inorganic Fiberglas!

BH EXTRA FLEXIBLE FIBERGLAS SLEEVING

2 WAYS BETTER

NON-FRAYING • NON-STIFFENING

FEW electrical insulations can double in brass as heat insulations. Yet so effectively heat resistant is BH Extra Flexible Fiberglas Sleeveing that actual service records show it refuses to burn even in direct contact with heat units. The reason—both yarns and impregnation are non-inflammable!

A special gum base and dye applied by an exclusive BH process is responsible for many more features. It permanently prevents fraying, stiffening and abrasive wear. The sleeveing is unusually flexible and takes the roughest handling without fraying. It does not harden and crack with age—lasts indefinitely without deterioration. It is also non-crystallizing at low temperatures.

Fiberglas is non-absorbent and unaffected by moisture, oil or grease—qualities ideally suited to appliance manufacture for instance. And it has high dielectric and tensile strength.

“Punishment” tests prove that BH Extra Flexible Fiberglas Sleeveing is the most logical insulation for a host of tough jobs. Why not see for yourself? It’s available in all standard colors and all sizes from No. 20 to $\frac{5}{8}$ ”, inclusive. Write for samples today and compare!

**BH SPECIAL TREATED FIBERGLAS SLEEVING
UNAFFECTED BY HEAT UP TO 1200°F!**

This is a high quality sleeveing that will not fray when cut and withstands heat up to 1200°F. Yet no saturant is used in the exclusive BH process! Flexible as string, too. Made in natural color only—all standard sizes. Try it!



ALSO SLOW-BURNING IMPREGNATED MAGNETO TUBING • SLOW-BURNING FLEXIBLE VARNISHED TUBING • SATURATED AND NON-SATURATED SLEEVING

BENTLEY, HARRIS MANUFACTURING CO.

Dept. I, Conshohocken, Penna.

RADIO SPEAKERS

for all applications

Recently expanded production facilities combined with complete engineering "know-how" enable Consolidated Radio Products Co. to supply the finest radio speakers available. Speakers can be furnished in the following ranges:

- Dynamic Speakers from 2 inches to 18 inches
- Permanent Magnet Speakers from 2 inches to 18 inches
- Headsets

Electronic and Magnetic Devices
CONSOLIDATED RADIO
Products Company
 350 W. ERIE ST., CHICAGO 10, ILL.

Small and Medium TRANSFORMERS

Consolidated Radio is also a nationally known manufacturer of small and medium transformers including Pulse Transformers, Solenoid and Search Coils.

Engineering service is available to design transformers and speakers for special applications, or to your specifications.

WIDE READING

Circle diagram

(Continued from page 112)

the two lengths d_1 and d_2 for closed stubs now become:

$$\cot \beta d_1 = \pm \frac{1}{(g_n)^{1/2}} (\cot^2 \beta d - g_n + 1)^{1/2} - \cot \beta d,$$

$$\cot \beta d_2 = \pm (g_n)^{1/2} (\cot^2 \beta d - g_n + 1)^{1/2} - \cot \beta d - b_R.$$

For a given double-stub spacing d , the greatest per unit conductance that can be matched to the feeder is

$$g_n]_{\max} = 1 + \cot^2 \beta d.$$

In both instances, for the single- and for the double-stub, the values of d_1 and d_2 , or d_1 and d_2 , respectively, may be determined with the aid of a circle diagram, Fig. 3 (p. 112). In this diagram, the abscissa is calibrated in per unit conductance, g , and the ordinate in per unit susceptance, b . Each circle of constant standing-wave ratio permits to find the per unit admittance for all points on a particular dissipationless line, terminated in a particular impedance. Any progression on the circle is equivalent to a progression on the actual line; the distance is measured by the phase difference indicated by the circles of constant phase which intersect the circles of constant standing-wave ratio. The conventional method of finding the single-stub length and its position is explained and a numerical example is given.

Double-stub diagram

In double-stub matching, the admittance of the load and stub d_2

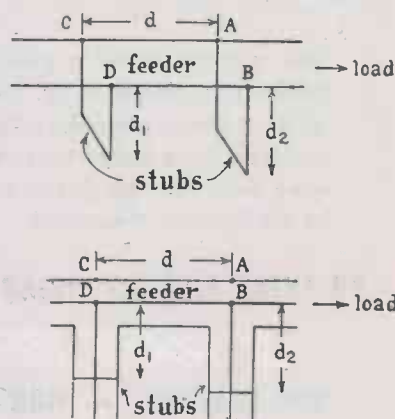

Fig. 2 Double-stub matching

are transformed by the section d of the line to an admittance whose per unit conductance is unity and which has some susceptance. Then, as in single-stub matching, the length d_1 of the second stub is adjusted to be equal to this susceptance but of opposite sign.

However, as the length d of the

How to get UNIFORM Spring Performance



STILL AVAILABLE

Thousands of copies of the Hunter Data Book, an original work on spring design and specifications, have been requested by product designers and manufacturers. Copies are still available without charge if requested on your letterhead.

IT IS A safe bet that no two things have ever been made which were exactly alike. How then is it possible to obtain from two, two hundred, or two million springs a performance in your product which is uniform? Well, it isn't possible except within certain tolerance limits. The probability of securing uniform performance is, however, mathematically and actually increased by the application of statistical methods in quality control. By an application of such methods, in use for years at the Hunter Pressed Steel Company, it is possible to check and control all of the various factors which may influence the quality character-

istics of the final product, to detect the tendency of a job to run out of control, and to make immediately the adjustments necessary to keep it in control. Statistical control of quality increases the probability of securing a greater number of okay springs in any given quantity and therefore immeasurably increases your certainty of obtaining springs which will perform with a greater degree of uniformity.

Statistical methods in quality control are, you can be sure, here to stay. Hunter has been a user of the science since 1932 as well as a contributor. Is there any reason any longer to buy guesswork springs?

CONTROLLED SPRINGS—The chances that in any batch of springs (as those below) you will secure the performance you require, are greatly increased by the application of statistical methods in quality control. In order to establish quality control, Hunter devised revolutionary methods of fast inspection, details of which are still confidential.

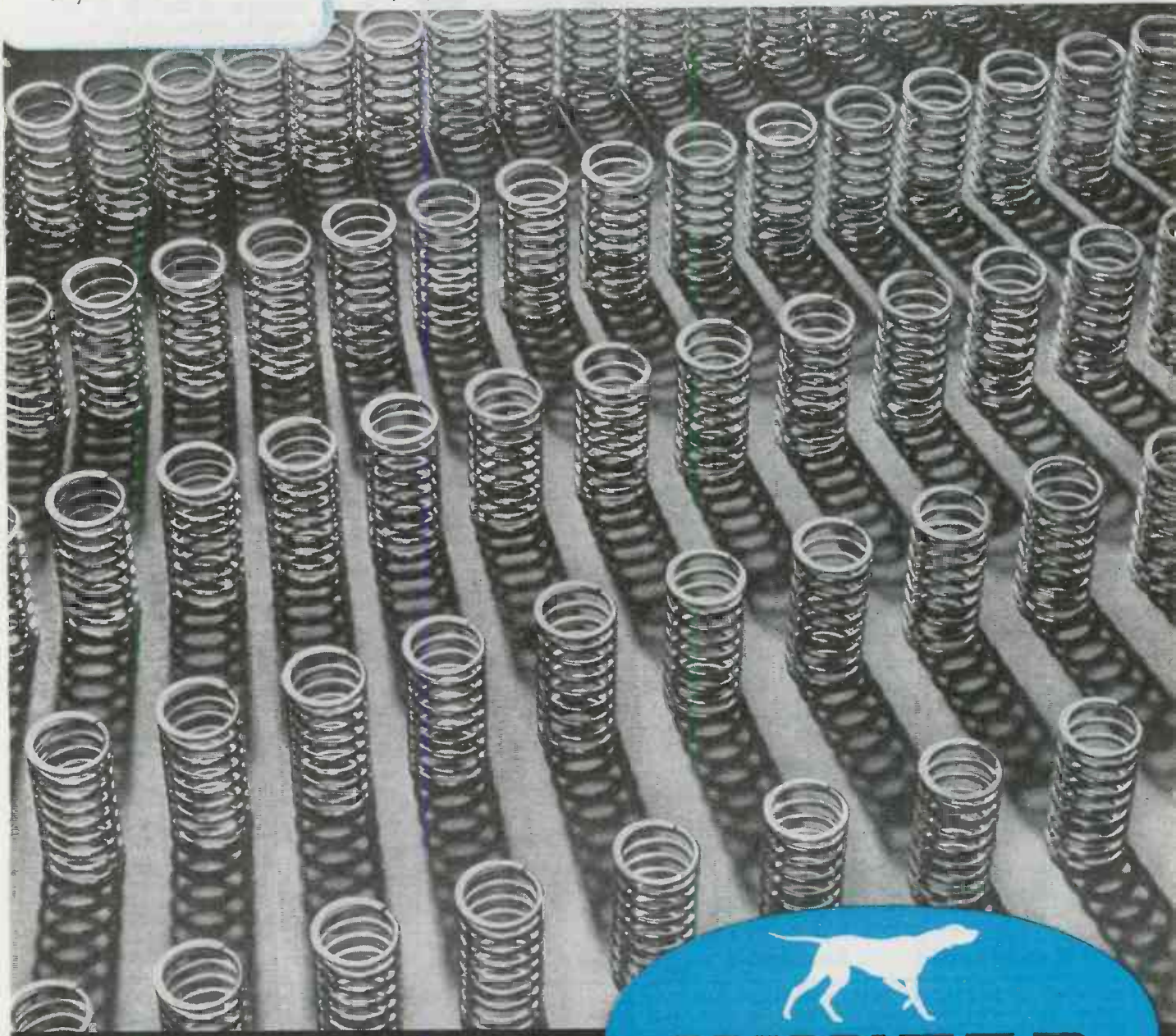

INDUSTRIAL SOUND EQUIPMENT

Available from Stock



NOW, you can quickly obtain all the benefits of modern, high quality Public Address, at low cost. KNIGHT Sound Systems, long proved by use in Industry and the Armed Services, can be shipped promptly from stock on priority rated orders.

With a KNIGHT System, you can relieve busy switchboards . . . quickly reach anyone in plant or office . . . reduce employee fatigue thru music. Increased efficiency and production more than pay for the sound installation.

Illustrated above is the KNIGHT 60-Watt Industrial Sound System with highly efficient reflex type trumpets. Assures clear, powerful voice and music reproduction. Adequately covers up to 200,000 sq. ft. of floor space, depending upon the existing noise level.

Complete system as shown, net . . . \$278.81

Other systems and accessories available to meet each requirement.

Write, Wire or Phone Haymarket 6800.

*High Power,
High Quality
P. A. for*

PAGING
ANNOUNCING
MUSIC
ALARMS

Helpful
BUYING
GUIDE
On Request
Write for it!

ALLIED RADIO

CORPORATION

833 W. Jackson Blvd. • Dept. 32-D-5 • Chicago 7, Illinois

SUPPLIERS OF ELECTRONIC PARTS AND EQUIPMENT TO INDUSTRIAL AMERICA
Electronic Tubes, Rectifiers, Power Supplies, Intercommunicating Systems, Sound Systems, Photo-Cell Equipment, Batteries, Chargers, Converters, Generators, Supplies for Resistance Welders, Fuses, Test Instruments, Meters, Broadcast Station Equipment, Relays, Condensers, Capacitors, Resistors, Rheostats, Transformers, Switches, Coaxial Cable, Wire, Soldering Irons, Microphones, Speakers, Technical Books, etc.

line section is fixed, only certain admittances of the load plus stub d_1 will be transformed to have a per unit conductance equal to unity. All admittances which will be so transformed by a given double-stub spacing d , are located on a circle in the diagram. These circles for $d = \lambda/8$, $d = \lambda/4$, and $d = 3\lambda/8$ are shown in the figure. Other circles, for any desired double-stub spacing d may be found; the center will be at $g = 1/(2 \sin^2 \beta d)$ and $-b = \cot \beta d$, and the radius will be $r = 1/(2 \sin^2 \beta d)$. The centers of all these circles will be located on the parabola shown in dotted lines. All circles are tangent to the axis of imaginaries and pass through the point, 1,0.

Numerical example

As an example of the use of the chart for double stubs, let $g_1 = 1.5$ and $b_1 = -1.0$ be the per unit conductance and per unit susceptance of the load connected to AB, and let the double-stub spacing $d = 3\lambda/8$. The first step is to add a susceptance in the form of a closed stub of length d_2 so that the combined per unit admittance falls on the circle marked "double stub, $3\lambda/8$ spacing". This is done by dropping vertically from point a, at 1.5, -1.0, to point b, at 1.5, -1.87, on the circle (follow heavy line). The per unit susceptance added is -0.87 which corresponds to a closed stub of 49 deg. (see two scales on left-hand margin of diagram) so that $\beta d_2 = 49$ deg.

From this point the solution is the same as for the single stub with $\beta d = 135$ deg., equivalent to $3\lambda/8$ length of line. The circle for constant standing wave ratio is followed (heavy line) through 135 deg., measured by the difference in the circles of constant phase, and point c is arrived at; point c is located on the vertical line for $g = 1$, indicating a per unit conductance equal to unity, as was intended with the construction of the double stub spacing circle. Point c has the coordinates 1, 1.58, so that the per unit susceptance of the stub d_1 must be -1.58. Therefore $\beta d_1 = 32$ deg., as indicated on the left-hand margin of the diagram (follow heavy line).

If the per unit conductance of the load does not fall within the range covered by the appropriate double stub spacing circle, a transforming line section must be employed between the load and stub d_2 , such that at the location of the stub d_1 the conductance looking toward the load falls within the proper range. For example, if the spacing between stubs is $3\lambda/8$, a load admittance whose per unit conductance is greater than 2 must be transformed into an admittance having a per unit conductance equal or less than 2, since the area

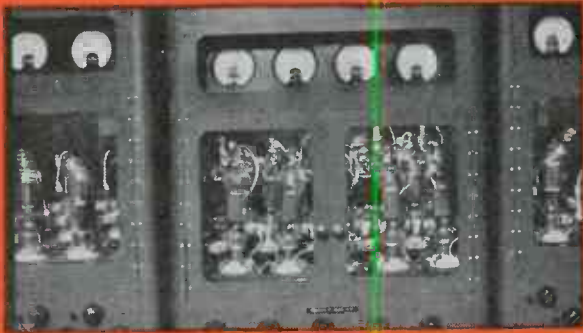

QST-1—Life testing is an important Quality Standard test at United. It is a strictly observed procedure whereby life expectancy is controlled in "run-of-production" tubes.



QST-2—A unique test is applied to every United tube to assure noise-free operation.

Who sets the *Quality Standard* FOR TRANSMITTING TUBES

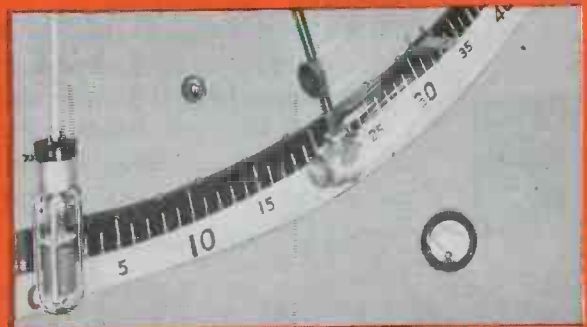

QST-3—United tubes designed for very rough service have extra, built-in shock resistance proved by the severe Bump Test each tube must pass.

Quality Standard Test.

Brilliant United craftsmanship is steadfastly verified and maintained by skillful and vigilant testing—truly representative of daily production. For this reason every United tube must pass through a series of critical examinations that do not permit any defects, no matter how minute they may be, to escape unnoticed.

By maintaining Quality Standard Tests of the highest order United engineers and technicians have

achieved recognition for leadership. To engineers everywhere, the name United is the trusted standard by which other transmitting tubes are judged and measured.

For every electronic application including radio communication, physiotherapy, industrial control and electronic heating, standardize with tubes that are the Quality Standard. "Tube up" with United.

Order direct or from your electronic parts jobber.

*Masterpiece of
Skilled Hands*



UNITED

ELECTRONICS COMPANY

NEWARK, 2



NEW JERSEY

Transmitting Tubes **EXCLUSIVELY** Since 1934

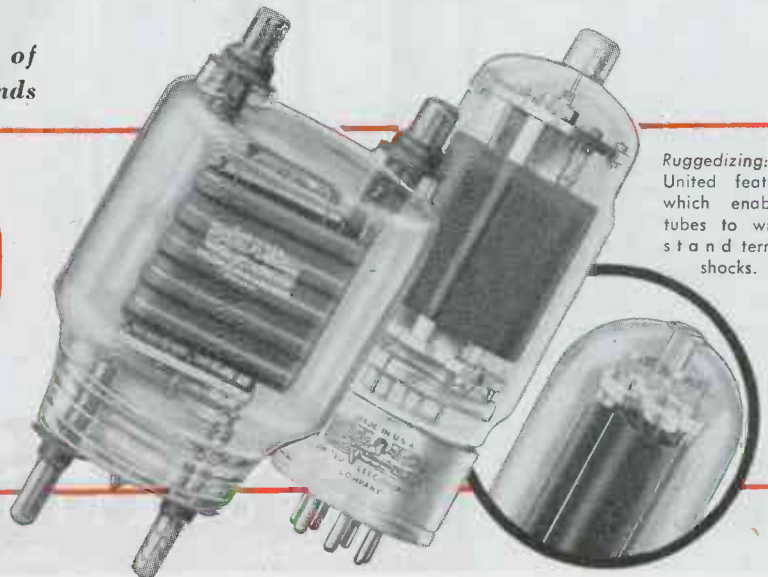

Ruggedizing: A United feature which enables tubes to withstand terrific shocks.



by the
DAWN'S EARLY LIGHT

The stage is set! Suddenly, shattering the hushed calm, hell breaks loose. Sharp orders are issued clearly from directional loud speakers and the infantrymen "hit the beach on the double," eventually to take another enemy base. Everything must dovetail . . . must be unfailing! Atlas Sound Speakers are beachhead veterans. Dawn will one day usher in an era of Peace. Soon Atlas veteran performance will again be available for civilian use.



Complete Atlas Sound Catalog on request.

ATLAS SOUND

CORPORATION

1445 39th Street

Brooklyn, N. Y.

SERVING ON WORLD WIDE BATTLE FRONTS

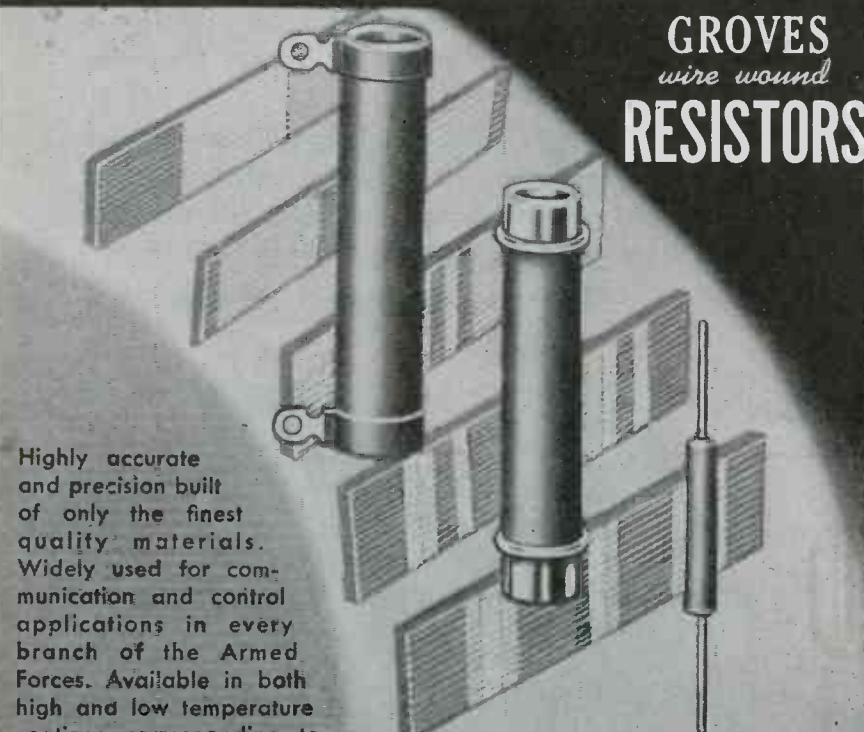

GROVES wire wound RESISTORS

Highly accurate and precision built of only the finest quality materials. Widely used for communication and control applications in every branch of the Armed Forces. Available in both high and low temperature coatings corresponding to the joint Army-Navy specifications.

GROVES CORPORATION

CAPE GIRARDEAU

MISSOURI

Catalog upon request.

within the $3\lambda/8$ double-stub spacing circle extends over a range limited by 0 and 2.

Effect of Oxygen on Secondary Emission

(Continued from page 112)

mined as a function of the primary electron energy at room temperature (293 deg. K.) and at the temperature of liquid air (83 deg. K.).

At room temperature the secondary emission coefficient for copper, silver and gold is hardly changed by the adsorbed oxygen; for silver compare curves 1 and 2 of figure 1. However, upon cooling to 83 deg. K., the coefficient increases, as illustrated by curve 3 in figure 1 for silver. Also the shape of the emission coefficient-primary electron energy curve is changed. Both effects are reversible, i.e., they decrease gradually with time, as illustrated by curves 3 and 5 of figure 1. The increase in the secondary electron emission is greatest for copper, smallest for gold. The presence of hydrogen eliminates the effect.

The secondary electron emission coefficient of an oxygen treated cadmium layer increases already at room temperature by about 100 per cent for slow primary electrons; the increase is less for fast moving primary electrons. This effect does not decrease with time but is a permanent change of the secondary electron emission coefficient by the oxygen treatment. The reversible increase through cooling to 83 deg. K. of the oxygen treated surface is smaller by a factor of ten than for the previously discussed group of metals.

The oxygen treatment of beryllium also causes a permanent increase in the secondary electron

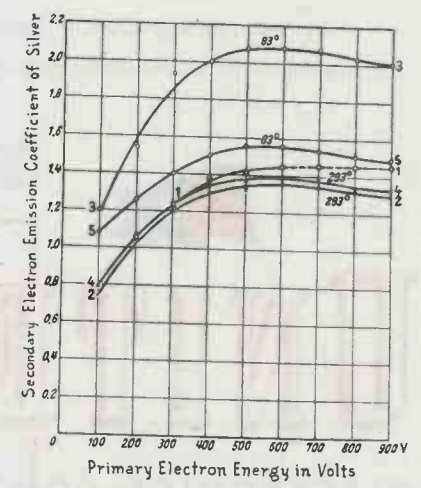

Fig. 1. Secondary electron emission coefficient of silver as function of primary electron energy. Curve 1, at 83 deg. K. before oxygen treatment; curve 2, at 293 deg. K., immediately after treatment; curve 3, at 83 deg. K., immediately after treatment; curve 4, at 293 deg. K., 11 hours after treatment; curve 5, at 83 deg. K., 11 hours after treatment

Accuracy plus Speed in Cathode-Ray Tube Production Tests

Cathode-Ray Tube
Characteristic
Test Set



Sherron Model C-2

This Sherron Model C-2 has been conceived to inspect Cathode-Ray tubes for the following:

- ELECTRICAL SHORTS BETWEEN ELEMENTS
- PRE-HEATING FOR INSPECTION OF TUBE
- HEATER CURRENT
- ANODE CURRENT
- GAS
- VOLTAGE BREAKDOWNS
- GRID CUT-OFF
- LEAKAGE: GRID #1, GRID #2
- SCREEN QUALITY
- LIGHT OUTPUT OF SCREEN
- FOCUSING CURRENT (AMPERE TURNS)
- SPOT POSITION AND DISPLACEMENT
- BEAM CURRENT
- LINE WIDTHS

**Sherron
Electronics**

... for Magnetic Or Electro-Static
Deflection Type Tubes

- Designed to check 3", 5", 7" magnetic type focus and deflection Cathode-Ray Tubes.
- Can be modified to check 2", 3", 5", 7" electro-static type deflection Cathode-Ray Tubes.
- Designed to cover all phases of safety.
- Readings of voltages and currents on meters located on front panel accelerate production tests.
- This unit can be equipped with automatic ejector to remove tube at completion of test.

The performance of the Cathode-Ray Tube in the wartime scheme of things presages an extraordinary range of applications in the peacetime future. We foresee quality control as a factor of ever-increasing significance. With an eye to tube manufacturers' high quality standards, we are projecting our model C-2 to anticipate their requirements. This Sherron unit will be available on a custom-built basis. It will be manufactured to the individual manufacturer's specifications. It can be manufactured to check the persistency of the different type screens used in Cathode-Ray Tubes, classified or unclassified.

SHERRON ELECTRONICS COMPANY

Division of Sherron Metallic Corporation
1201 FLUSHING AVENUE, BROOKLYN 6, N. Y.

"Where the Ideal is the Standard, Sherron Units are Standard Equipment"

BETTER PERMANENT MAGNETS

for:

RADIO, SOUND and
COMMUNICATIONS
EQUIPMENT

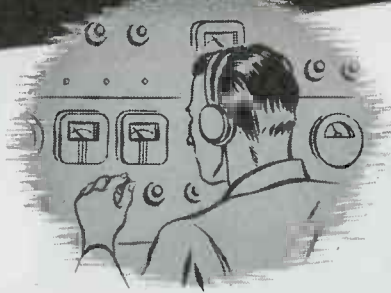

AUTOMOTIVE
and AVIATION
EQUIPMENT

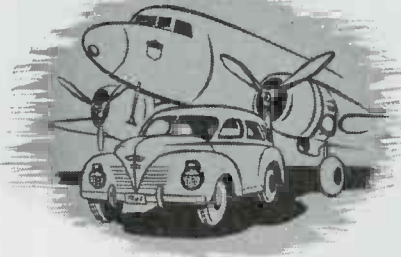

INSTRUMENTS

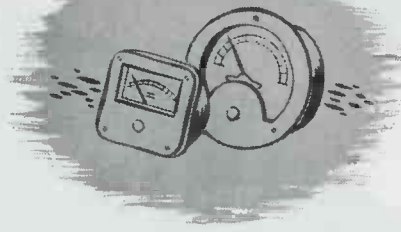

However advanced your own product-development work may be . . . however new or revolutionary the permanent magnets you require . . . Arnold engineers can be of considerable assistance to you in supplying the proper permanent magnets *in volume*. They're precision-built entirely in our own plant, under the closest metallurgical, mechanical and magnetic control to assure peak efficiency at the lowest cost.



NEW! Get your copy of this valuable, up-to-the-minute manual on the design, production and application of modern Alnico permanent magnets. Write us, on your company letterhead, today.

Specialists in the manufacture of
ALNICO PERMANENT MAGNETS

THE ARNOLD ENGINEERING COMPANY

147 EAST ONTARIO STREET, CHICAGO 11, ILLINOIS

emission ratio, see curves 1 and 3 of figure 2. The reversible increase of the secondary electron emission coefficient upon cooling to 83 deg. K. is only small, compare curves 2 and 3 of figure 2. A considerable further permanent increase in the secondary electron emission coefficient is obtained if the oxygen treatment takes place at higher than room temperature; curve 4 of figure 2 shows the result of treatment at 623 deg. K.

The reversible temperature dependence of the secondary electron emission is explained by the influence of the temperature on the interaction of crystal lattice and oxygen dissolved in the outer metal layers. Oxidation of the metal surface may be responsible for the permanent, temperature-independent increase observed with cadmium and beryllium.

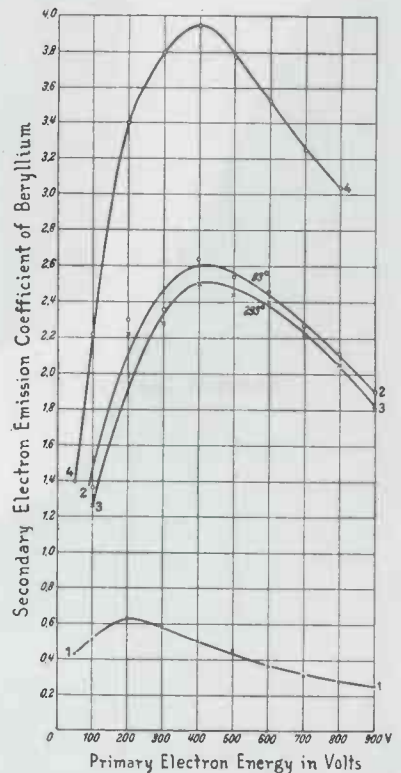

Fig. 2. Secondary electron emission coefficient of beryllium as function of primary electron energy. Curve 1, before oxygen treatment; curve 2, at 83 deg. K., after treatment; curve 3, at 293 deg. K., after treatment; curve 4, at 623 deg. K., after oxygen treatment at 623 deg. K.

Push-Pull Circuit

D. H. Parnum (Wireless World, London, January, 1945).

The purpose of the circuit is to provide, alternatively, push-pull or single-ended output from a push-pull stage without the use of a transformer. Voltages of opposite sign with respect to ground and odd harmonics constitute the output, while voltages of equal sign with respect to ground and even

(Continued on page 174)

*A complete, compact test-bench
in a single unit!*



...the new **RCA 170-A AUDIO CHANALYST**
that tests everything—from microphone to multiple speakers

Available on rated orders
FOR COMPLETE INFORMATION
Use The Coupon

Test & Measuring Equipment
Dept. 1101
Radio Corporation of America,
Camden, New Jersey
Please send me complete information
about the new RCA 170-A
Audio Chanalyst.

Name.....
Company.....
Street.....
City.....State.....
97-6136-110

● With the 170-A you can systematically test any sound system completely for failure to operate, weak output, interrupted operation, and distorted or noisy output.

● You can check the presence, absence, or character of a signal throughout its path—from source to load.

● You can check gains or losses, measure component values, and test the voltages of any item supporting or controlling the signal.

● You can narrow down poor performance to its cause, and locate the defective part in an amazingly short time.

● You can use it to solve signal-interruption problems by multi-channel monitoring.

● In an emergency, you can use the RCA Audio Chanalyst to substitute for defective amplifiers by bridging the signal through it, and thus around the defect.

BUY MORE WAR BONDS



RADIO CORPORATION OF AMERICA

RCA VICTOR DIVISION • CAMDEN, N. J.

In Canada, RCA VICTOR COMPANY LIMITED, Montreal

How

● The automatic stacking machines shown have enabled Sangamo to play an important part in meeting the heavy and exacting requirements of wartime America. Well-trained operators, adequate facilities, and competent supervision have contributed in some measure to helping the United States to become the world's leader in Electronic developments.



THESE OPERATORS who assemble Sangamo mica capacitors are fully aware of the dependability required in their performance. They know that full quality must be built into these units to meet the high standard set

at Sangamo. Skilled operators, utilizing the most modern mechanical equipment, contribute to the excellence of the finished product, be it the smallest or the largest capacitor.

SANGAMO ELECTRIC

ESTABLISHED 1898 • • • MICA CAPACITORS • • •

EXCELLENCE IS BUILT INTO....

Sangamo

MICA CAPACITORS

Capacitor Assembly

A MICA CAPACITOR consists of a number of alternate layers of mica film and a conducting metal plate. As the capacity of the unit varies directly with the area of the active surface of the plate and inversely with the thickness of the dielectric, these factors must be accurately controlled in order to produce a satisfactory capacitor.

The assembling or stacking of these units may be done by hand with the use of mechanical stacking fixtures, or automatically, by utilizing special assembly machines. Since 1929, automatic machines, designed and developed by Sangamo, have been used for stacking many types of Sangamo capacitors. This method of stacking has insured accurate positioning of the foil, which is essential for long life and trouble-free operation of any capacitor unit. The automatic assembly machines are designed so that the length of each foil is very accurately controlled; as the mica previously has been gauged to within very close limits and inspected for all defects or flaws, a uniform capacitor results. Since many of the large capacitors consist of series sections and comprise in all many hundreds, and in some cases thousands, of pieces of mica, automatic stacking insures consistent quality and facilitates increased production. A large battery of these assembling machines enables Sangamo to produce many thousands of capacitors of all values each day and each is built with that precision and care required to insure dependable operation in all types of electronic equipment.



COMPANY SPRINGFIELD ILLINOIS

• • WATT HOUR METERS • • • TIME SWITCHES • • •

**1/4 H. P.
TAKES THE PLACE OF
1000 H. P.**

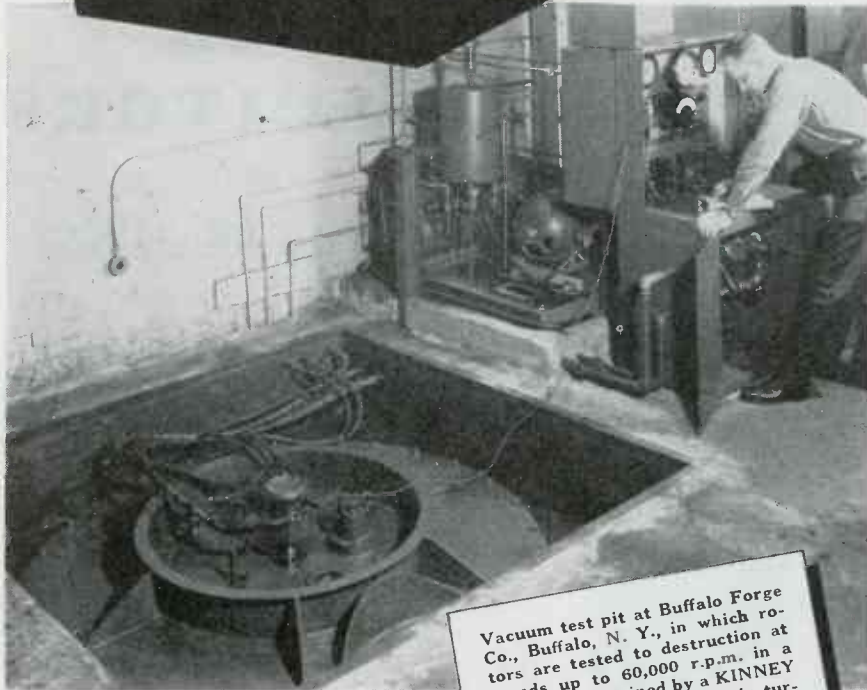

Vacuum test pit at Buffalo Forge Co., Buffalo, N. Y., in which rotors are tested to destruction at speeds up to 60,000 r.p.m. in a vacuum maintained by a KINNEY Vacuum Pump. A small air turbine, developing about 1/4 H.P., actually revolves the rotor which, under normal atmospheric conditions, would require a 1000 H.P. motor.

Thanks to a ..
KINNEY
HIGH VACUUM
PUMP

Thousands of KINNEY Vacuum Pumps are serving Industry in countless ways, maintaining the low absolute pressures required in making electronic products, in sintering alloy metals, in coating lenses and producing drugs. Proved and dependable, they can be relied upon for years of exacting service. KINNEY Single Stage Vacuum Pumps maintain low absolute pressures down to 10 microns; KINNEY Compound Vacuum Pumps to 0.5 micron.

Further information on request

KINNEY MANUFACTURING CO.

3595 Washington Street, Boston 30, Mass.

NEW YORK . CHICAGO . PHILADELPHIA . LOS ANGELES . SAN FRANCISCO

We also manufacture

Vacuum Tight Valves, Liquid Pumps, Clutches and Bituminous Distributors

harmonics are eliminated, as is the case in conventional push-pull circuits.

In the push-pull circuit shown, plates and cathodes are loaded with equal resistors R and R_k . The plate of each tube is coupled to the cathode load of the other tube through a center-tapped capacitor; these center-taps are the output terminals of the circuit. The two circuits are assumed to be identical. Then, the voltage drops across the four resistors R and R_k will all be equal in magnitude; the instantaneous polarity of these voltages will depend on the type of input.

For input voltages of opposite polarity with respect to ground, or for odd harmonics, the instantaneous polarities are those indicated in the diagram without parenthesis. It will be seen that there is no voltage across capacitors C , and their center points will be at the potential of the corresponding plate. Consequently, the output will be as if taken from the two plates, i.e., it will be reproduced with a gain of slightly less than unity. The voltages at the output terminals will be of equal magnitude, even though the two input voltages differ in magnitude.

However, for input voltages of equal polarity with respect to ground, or for even harmonics, the polarities will be as indicated by the signs in parenthesis. Both center-points of the capacitors C being at

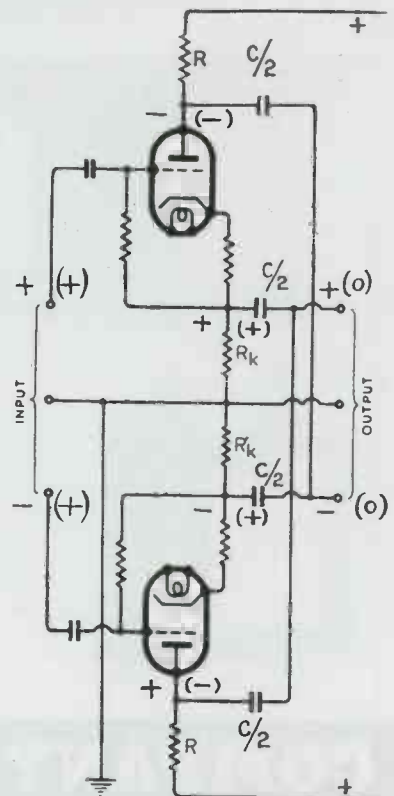

Push-pull circuit connected for push-pull or single-ended output

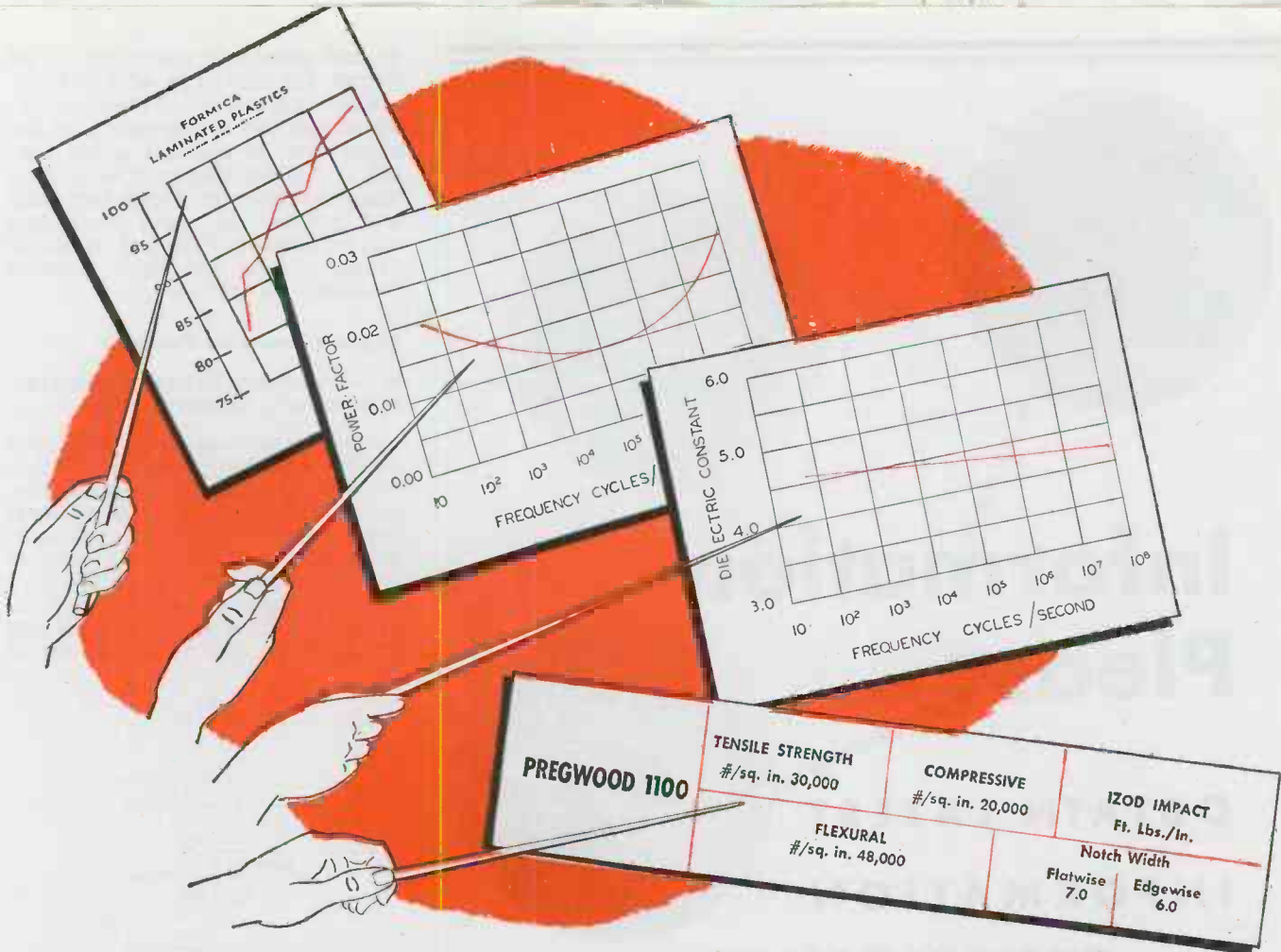

BETTER INFORMATION

on the Qualities of Laminated Plastics!

THERE has been a big improvement lately in the variety and quality of the engineering information on the physical and chemical qualities of Formica.

This has been brought about by recent application of the latest testing equipment to Formica's tests in the Formica laboratory, and the enlargement of the engineering staff to make thousands of new tests possible.

After the war you can really get the dope on the grades of Formica you may be considering for your various applications. It will be as complete and thorough as that available for any other material.



THE FORMICA INSULATION CO., 4647 SPRING GROVE AVE., CINCINNATI 32, O.



Information Please...

OBTAIN LATEST INFORMATION ON CRYSTIONICS* NOW

your postwar communications problems will be tackled and solved right now by . . . Valpey Crystal Corporation. Your problem on crystal application written on your business letterhead will bring you complete data.

*QUARTZ CRYSTALS AS APPLIED TO ELECTRONICS



CM-1
A design for normal frequency control applications.



CBC-0
Where utmost in stability requires constant temperature control in commercial installations.

NEW XLS
Special new low frequency unit . . . vital in the newer fields of electronics.

VALPEY

Crystal Corp.

CRAFTSMANSHIP IN CRYSTALS SINCE 1931
HOLLISTON, MASSACHUSETTS

ground potential, there will be no output for this type of input.

Push-pull output is obtained between the two center-points of the capacitors. If a single-ended output is desired, this may be derived between either of these terminals and ground; no even harmonics will be present. Practical details of actual circuits and their probable troubles are discussed.

Input Circuit to Counter

E. L. Langberg (Review of Scientific Instruments, January, 1945).

The circuit has been developed for use with low impedance counters, for instance, a Cenco counter, capable of counting up to at least thirty counts per second. A positive pulse of the order of 35 volts is needed to trigger the circuit.

In the quiescent condition, V_1 is de-ionized, C_1 is fully charged, and points A, B, and C are at the B

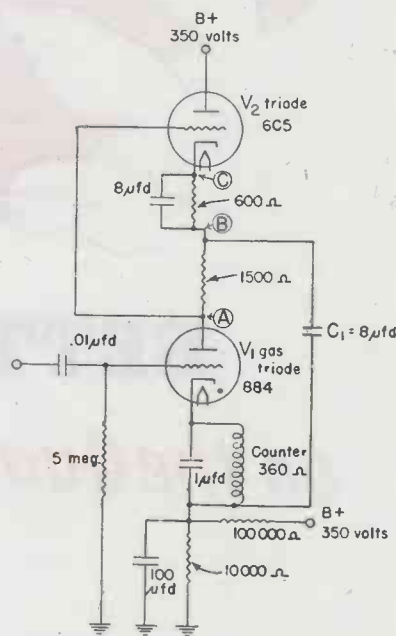

supply potential. A positive pulse applied to the grid of V_1 will fire the tube and discharge C_1 through the counter, thus actuating it. Simultaneously, the voltage drop between points A and B will cut off tube V_2 , permitting discharge of C_1 until the plate of V_1 has gone low enough for it to de-ionize and stop conducting. Points A and B will then again be at equal potentials and C_1 will charge through V_2 .

Experiments with Horizontal Antennas

N. Wells (Journal of the Institution of Electrical Engineers, London, Part III, December, 1945).

Experiments relating to the design of a non-directional, wide-band, horizontal antenna for short waves are reported in detail. The two problems discussed are (1)



THEIR SMALL
MOTORS
ARE TOPS!

THEY'RE RIGHT SMART
ABOUT MOLDED
PLASTICS, TOO!

IT IS EASY to see that both these gentlemen are satisfied customers of General Industries. One acclaims our "know-how" in molded plastic parts — the other our velvety *Smooth Power* motors. Yes, we do both jobs under one roof and one management.

GENTLEMEN, YOU'RE BOTH RIGHT!



The plastic parts buyer has profited from the ingenious skill of our mold makers, who enable us to turn out tricky jobs economically and on time. Quite likely he has seen our up-to-date equipment for compression, transfer and injection molding of large or small parts in any quantities. Our engineers have made sensible and workable suggestions, by reading between his blueprint lines. He is typical of leading manufacturers in many fields who rely upon General Industries plastics division.



The speaker on *Smooth Power* motors might be a radio-phonograph builder who uses our turntables, record changers and recorders. Or he might be a designer who depends upon these fine low-torque drives to power electric, electronic or mechanical devices. In any case, he's well acquainted with the facilities of our *Smooth Power* motor division.

We want to emphasize the point that we're a thoroughly able producer of both these products. If your plans call for either or both, we'd like to work with you. In your request for details, please address the respective division . . . *small motors or plastics.*

THE
GI GENERAL
INDUSTRIES
COMPANY
ELYRIA, OHIO



LOOK TO THE LEADER FOR LEADERSHIP

LARGEST LINE OF

Underwriters' Approved and Listed

PILOT LIGHT ASSEMBLIES

Gothard has established a policy for the approval of all leading Pilot Light Assemblies in the Gothard Line to meet the ever increasing demand for approved component parts. This feature, plus such Gothard developments as rigid non-short terminals, generally higher standards in light dispersion, and special engineering service for unusual requirements is your guarantee of maximum efficiency and lasting quality in every Gothard Assembly.

GOTHARD No. 1216 NEON LIGHT ASSEMBLY

Designed especially to accommodate the low cost NE-45 Neon Lamp, this assembly is particularly suited to continuous operation—to indicate equipment is "ON". The NE-45 lamp has an approximate lifetime of 3000 hours as compared to the 100 hour lifetime of the ordinary lamp. An unbreakable lucite protective cap, designed and made for Gothard exclusively, provides perfect light dispersion of the warm neon glow in all directions. See catalog for details.



Request New Gothard Catalog.

Gothard

MANUFACTURING COMPANY

1315 NORTH NINTH STREET

SPRINGFIELD, ILLINOIS

CANADIAN DISTRIBUTOR—William F. Kelly, 1207 Bay Street, Toronto 5, Ontario.

EXPORT DIVISION—25 Warren Street, New York 7, N. Y.

CABLES—Simontrice, New York.

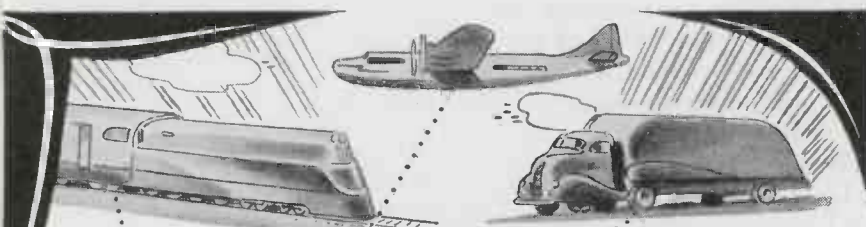

TRANSFORMERS

for TRANSPORTATION APPLICATIONS



Wherever specialized transformers are required for transportation applications, you will find a high-quality transformer designed and engineered by Electronic Engineering Co., a modern mass production organization . . . For communications equipment in airplanes and trucks, for blind-flying controls and landing apparatus in planes, for signaling and safety equipment in trains, rely on Electronic Engineering Co. for the solution to your problem.

ELECTRONIC ENGINEERING CO.

735 West Ohio Street • Chicago 10, Illinois

Associated Company

Holubow and Rehfeldt Consulting Engineers

Transformer Engineers for Specialized Applications

what form of horizontal antenna will yield a substantially non-directional radiation pattern in the horizontal plane at some given frequency, and (2) will not depart from that pattern by more than a predetermined amount when the frequency is changed over a reasonably wide band.

A quadrant antenna, i.e., a right-angle, V-shaped antenna fed in antiphase at the apex, was adopted. As a result of tests, it was established that the quadrant antenna has a substantial non-directional diagram when its limbs were of the order of one-half wavelength long, and that it was the only one for which the change in shape of the radiation pattern with a change in frequency was sufficiently small.

Frequency dependence

If it is assumed that results are no longer satisfactory when, upon a change in frequency, any of the minima in the radiation pattern fall below 50 per cent of the original strength, the frequency may be increased by 30 per cent over the datum frequency. With a decrease in frequency the change in radiation pattern is not so critical, but as a decrease in frequency entails decrease in equivalent arm length and, hence, decrease in radiation resistance, there is an increase in losses, which imposes a limit.

A twin, square-form, four-wire cage was constructed and tested. Its input impedance was measured as a function of frequency. The natural frequency of the antenna was about 8.75 mc., and for the range between 5.75 and 11.5 mc. the variation in the absolute value of the impedance was a rise from 320 ohms to 1000 ohms with a subsequent drop to 335 ohms. This variation is considered satisfactory.

Matching of the transfer impedance to the varying impedance of the antenna is examined, and the most favorable dimensioning and grouping of the antenna is considered. Horizontal and vertical polar diagrams are described; polarization of the generated waves is investigated; characteristics of stacked quadrant arrays are discussed. Diagrams and tables of measured and computed results in connection with the problems treated are included.

Mercury Relays

An improved series of normally open mercury plunger relays is illustrated and described in a catalog sheet from H-B Electric Co., 6122 North 21st St., Philadelphia. The sheet gives engineering data on the relays which depend for action upon the displacement of a mercury pool through the movement of a plunger.

THE FACTS ABOUT SMALL

METAL TUBING UP TO 5/8" OD

Superior facilities are devoted exclusively to the production of small metal tubing. Long before the war we set our maximum size at 5/8" OD because experience has shown that only by so doing could we maintain high quality in the smaller diameters. As a result, we have a mill, operating at top speed, equipped to produce in a routine manner what formerly was known as "specialty" tubing. So, if you need cold drawn tubing in any metal, and the OD does not exceed 5/8"—then the inherent benefits of our specialization are yours for the using.

SUPERIOR

SUPERIOR TUBE COMPANY, NORRISTOWN, PENNSYLVANIA



THE BIG NAME IN
**SMALL
TUBING**

FOR EVERY SMALL TUBING APPLICATION FROM 5/8" OD DOWN

SUPERIOR  Seamless in various analyses. WELD-DRAWN  Welded and drawn Stainless, "Monel" and "Inconel"

SEAMLESS and Patented LOCKSEAM Cathode Sleeves

Specialists

... in Assembly and sub-assembly
of Precision Electronic Products

- Complete Facilities for Production
and Testing of Audio Equipment
- Consult us with your Production
Assembling Problems

RADELL

C O R P O R A T I O N

6323-27 GUILFORD AVENUE, INDIANAPOLIS 5, INDIANA

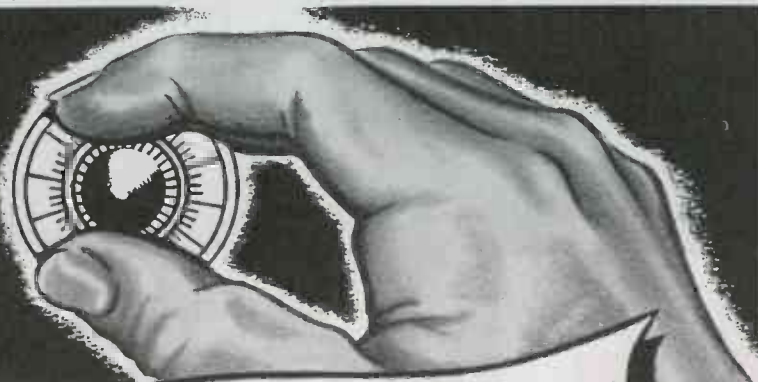

For Perfect Calibration
MONARCH
MEASURING • TESTING • CALIBRATING
EQUIPMENT

For better war production • For finer civilian production

Throughout the war period, Monarch instruments have facilitated production of better equipment, giving more accurate results. As soon as conditions permit, these same dependable instruments will be used to insure finer results in products designed for civilian use.



STABILITY

(Continued from page 97)

effects in the design of the oscillator tuning unit itself. These effects, moreover, follow different laws and can be made either positive or negative. No one set of rules can be set up as to a "best" method, as will be shown later. Here a tabulation of possibilities may be of interest.

Assume four metals are available for the fabrication of the oscillator tuning unit, one of invar, one with a medium coefficient such as stainless steel, and a third and fourth with higher expansion such as brass and aluminum. Their respective coefficients vary roughly in the following order, 1:12:18:22. To show trends only (but not for design usage, since the absolute values depend on factors not considered) the curves in Fig. 4 give relative values of typical temperature coefficients with typical materials in construction. These curves hold only when the frame and shaft of a capacitor expand equally, keeping airgaps equalized. In the curves here, a positive coefficient indicates that the capacitance increases as temperature is raised. The units are arbitrary but are roughly parts per million per degree Cent.

Non-parallel plates

With some designs of capacitors used in receivers it is easier to equalize the spacing than it is to keep all plates parallel with each other and perpendicular to the axis of revolution. If the latter variation occurs, the temperature coefficient changes in a complex manner as the dial is turned, and there is no way of securing accurate compensation of drift variations, as there is when the condition of unequally spaced but parallel plates exist.

It is quite possible—and, in fact, this method has been used—to provide for compensation of temperature drift by a preliminary misadjustment of the spacing, so that expansion changes move the shaft so as either to improve the spacing or to make it "worse," as the complete circuit characteristics dictate. This is providing for operation at some selected point on the curve Fig. 3, getting either positive or negative compensation at will.

Circuit designers bent on getting lowest drift effects must analyze these tuning capacitor characteristics first and set up acceptance tests that will insure, first that all plates are sufficiently parallel and perpendicular to the axis of rotation. Next in importance, is that the spacing be equalized precisely, according to mechanical gaging tests, or better yet, so as to provide minimum capacitance at the maxi-

**Guidance for accuracy
in laboratory and
production testing...**

DECADE INDUCTANCE



ISOLATING TRANSFORMER

N.Y.T. INSTRUMENTS



VOLTMETER CALIBRATOR

SPECIAL DECADE INDUCTANCE:
Available ranges 0.01, 0.1, 1.0, 10, 100 henries. Accuracy $\pm 2\%$ at 1000 cycles. Standard types in other ranges with accuracy $\pm 5\%$.

PORTABLE ISOLATING TRANSFORMER:

Compact, efficient, light-weight. Rating 250 V.A., 115 volts, ratio 1:1, 3 phase. Wide frequency range—60 to 2400 cycles.

VOLTMETER CALIBRATOR:

A self-contained source of exact AC voltage for meter calibration purposes. Voltage accurate to $\frac{1}{2}\%$ or better. Eliminates expensive standard calibrating meters. Range .01 to 1000 volts, in steps of .01 volt.



A noteworthy addition to the highly specialized N.Y.T. line of custom designed transformers, chokes and filters is this new precision test equipment. The N.Y.T. Decade Inductance, the N.Y.T. Isolating Transformer and the N.Y.T. Voltmeter Calibrator all embody the high degree of quality and engi-

neering heretofore associated with this name.

N.Y.T. engineers have other post-war projections already in the blueprint stage. Each will fulfill a purpose and need in industry... each will formulate a nucleus for continued achievement in the field of electronic engineering. Data on request—no obligation incurred, of course. Dept. N.

NEW YORK TRANSFORMER CO.

26 WAVERLY PLACE, NEW YORK 3, N. Y.

Engineers, please note:-
**211 TYPES of DIALCO
 PILOT LIGHTS**
 provide rapid
 solutions to
 every problem

Consider your Pilot Light problem solved! The extensive Dialco line covers every conceivable application — Aircraft; Marine, Electrical, Electronic, Radio, and Industrial. We are geared to supply COMPLETE ASSEMBLIES, housing required G.E. or Westinghouse Lamps. Special emphasis on NEON applications. Send data for estimates, suggestions, and samples.



Write for CATALOG

World's Largest Manufacturer of Pilot Lights

DIALCO

DIAL LIGHT CO. of America, Inc.
 900 BROADWAY • NEW YORK 3, N. Y.
 Telephone: ALgonquin 4-5180-1-2-3

mum setting. Only then is it possible to analyze and compensate for other circuit variations brought about by temperature changes.

Fig. 4 shows a typical tuning combination found in receiver oscillator circuits. For first analysis it can be assumed that the loading and resistance factors can be neglected. The frequency at normal temperature is therefore proportional to

$$f_n = k \frac{1}{\sqrt{L(C+C_D)}}$$

At another temperature the frequency f_2 depends on

$$\frac{k}{\sqrt{(L+\Delta L)(C+\Delta C+C_D+\Delta C_D)}}$$

where the values of ΔL and ΔC_D are independent of the setting of the capacitor and may be either positive or negative. The value of ΔC might follow any kind of variation law with setting, however. It might be assumed that the plates are parallel and so ΔC is approximately linearly proportional to C . This is about the only rule that can be assumed with any degree of propriety.

It happens also that it is extremely difficult to measure experimentally the values of ΔC or even of ΔL . If the whole circuit is placed in a temperature oven or icebox, all circuit factors change according to the relation shown in the preceding equation. If only the coil or the capacitor are heated or cooled, it is difficult to ascribe values to the variations in the leads connecting that component to the rest of the circuit. Such leads have both inductance and capacitance effects sufficient to make the complete oscillator no longer representative of the oscillator under test.

It is possible, of course, to measure the total drift more accurately than it is possible to measure almost any other quantity, but it is only when it comes to placing the blame on the various components that difficulties arise. With careful analysis, however, and a few temperature runs, these answers can be arrived at.

One can run a test with the capacitor plates entirely unmeshed. Such a test shows up the combined drift due to ΔL and to ΔC_D since C (and therefore ΔC) is equal to zero. Then it is possible to add another fixed capacitance (one whose temperature coefficient is known) across the circuit, and make another temperature run. From these data (Δf vs. Δt) the relative importance of ΔL and ΔC_D can be determined, assuming, however, that the switching mechanism by which this extra capacitance is added or removed does not influence the results.

If you want

- CRYSTALS
- CABLES
- HARNESES
- ELECTRONIC ASSEMBLIES
- CABINETS

Telephone Peru, Indiana
151

Serving the Radio and Electronic Industries with precision engineered products.

Wm. T. WALLACE MFG. Co.
 General Offices: PERU, INDIANA
 Cable Assembly Division: ROCHESTER, INDIANA

transformer designs

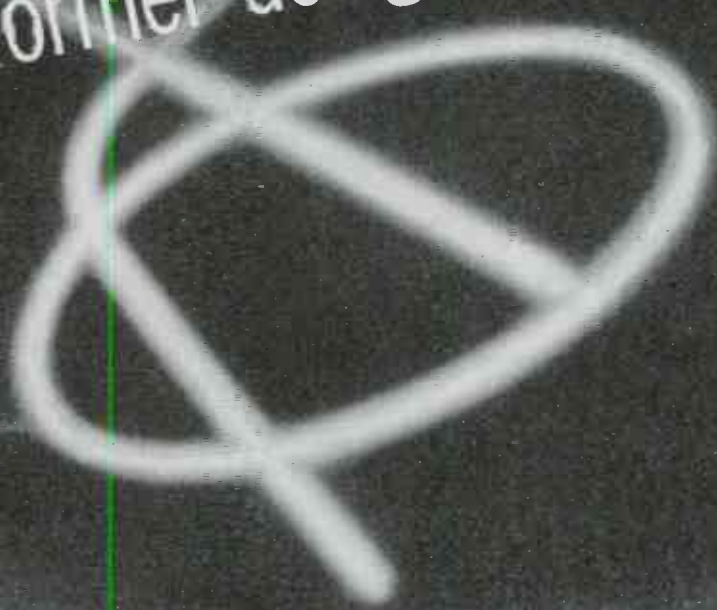

FOR *Every* ELECTRONIC NEED

Although specialists in the design and quantity production of transformers for a quarter century, the demands of the past few years have brought about many developments. The requirements for military and essential industry purposes have multiplied many-fold with further emphasis on exactness and uniformity.

Transformer specialists before the War—great strides have been made in anticipating and meeting requirements of greatly varied character that have multiplied many-fold for military and essential industrial purposes.

Reports from all over the world emphasize the reliability of Jefferson Electric Transformers. Wherever used—on land, sea or in the air—in the frozen North, or hot, dry or humid tropics, the value of "quality" is being demonstrated daily.

Now is a good time to study your transformer requirements and let Jefferson engineers make recommendations that will save you time later.

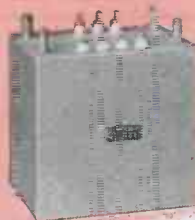
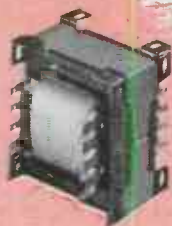

JEFFERSON ELECTRIC COMPANY



BELLWOOD (SUBURB OF CHICAGO) ILLINOIS

IN CANADA: CANADIAN JEFFERSON ELECTRIC CO. LTD., 384 PAPE AVENUE, TORONTO, ONT.

Established 39 Years Ago



THE NAME TO REMEMBER IN

ANTENNAS

FOR EVERY RADIO PURPOSE

Today Antennas

are serving the nation's armed forces on land, on sea, and in the air.

But after the war . . .

look to BRACH improved facilities, BRACH engineering, and BRACH production technique as your most desirable source for Puratone* Antennas for Home and Auto Radios, Television, Marine, F.M., and other services.

*Reg. Patent Trade Mark



In almost any kind of a circuit an actual switch cannot be trusted in this regard. In some set-ups the auxiliary fixed capacitance can be jerked out of the circuit while in operation inside of a temperature chamber, by pulling a string or thread. Two runs, with and without the auxiliary capacitor, are thus possible from which the following relations hold. (Note, the tuning capacitor plates are still in an unmeshed position.)

$$\frac{f_1 - \Delta f_1}{f_2 - \Delta f_2} = \sqrt{1 + \frac{C_D + \Delta C_D}{C_D + \Delta C_D}}$$

Here C_D , ΔC_D and C_b are known or measurable, and f_1 and Δf_1 are the frequency and the drift respectively over a temperature range t , with C_D in place, and f_2 and Δf_2 the equivalent values without C_D . The Δ values may turn out to be either positive or negative.

The value of ΔC_D computed from eq. (4) can be substituted in eq. (3) and then ΔL obtained. The value of C_b was defined as all the capacitance left in the circuit when the tuning unit plates were entirely unmeshed. This value and the value of ΔC_D will not change at other frequencies as the tuning unit is altered.

It is a debatable matter as to whether ΔL can be assumed to be independent of the value of C since the current distribution may change with frequency and the center of capacitance (and hence the physical length of the circuit) may shift, altering the inductance. Except at UHF, where the lumped inductance does not provide substantially all of the total inductance, the assumption is valid, however.

The value of ΔL can also be checked by providing a switching arrangement that will apply a few volts temporarily across the coil from a battery to heat up the coil, the rest of the components remaining cool. After noting the frequency drift as the temperature is reduced by cooling the whole oscillator, the coil is rapidly heated by this means to a high (but safe) temperature. The actual coil temperature can be determined by noting the resistance change in the battery heater circuit, provided the coil has enough resistance to overshadow the external circuit resistance.

It is one matter to determine the inductance shift with temperature, for a certain coil but a designer will have to go farther and determine coil design factors which will modify this coefficient in some prescribed manner, so that the overall circuit drift is at a minimum. These matters will be taken up in Part II in a succeeding issue.

L. S. BRACH MFG. CORP.

World's Oldest and Largest Manufacturers of Radio Antennas and Accessories
55-65 DICKERSON STREET • NEWARK N. J.

VACUUM TUBE DESIGNER

An Eastern manufacturer has an attractive opportunity for a graduate physicist or electrical engineer with several years of practical experience in vacuum tube design. It is necessary that applicants have sufficient production experience to develop designs which will improve quality and reduce cost through lowered shrinkage. . . . Furnish full details regarding experience, education, age, and salary requirements. **BOX 3572**

ELECTRONIC INDUSTRIES, 480 Lexington Ave., New York 17, N. Y.

POWER

HIGH FREQUENCY HEATING

INTERNATIONAL BROADCAST

FTR

The Most Powerful High-Frequency Tube

200 Kilowatts—developed especially for high-power, high-frequency broadcast and industrial applications.

Into this development has gone all the knowledge and experience of the tube-building art that make the name Federal stand for dependability—a reputation earned by more than 35 years of service in the electronics field.

Federal tubes are built for long life . . . produced with all the care and precision of fine craftsmanship.

Federal always has made better tubes.



Federal Telephone and Radio Corporation



Newark 1, N. J.

FOR INDUSTRIAL ELECTRONIC DEVICES

What Relay?

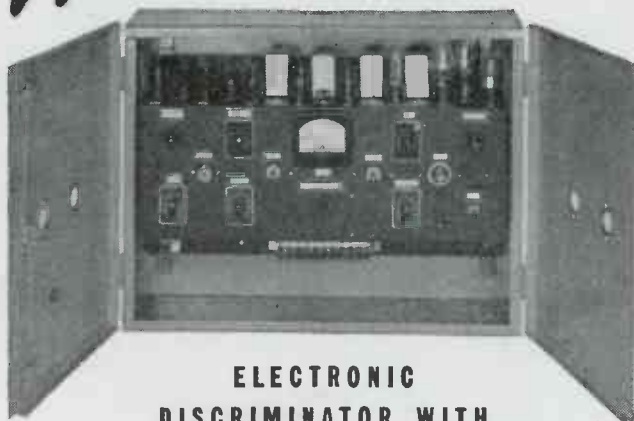

**ELECTRONIC
DISCRIMINATOR WITH
"SIGMA" PLUG-IN RELAYS**

The relay, like all components, must have maximum freedom from possibility of failure—and also, because it may nevertheless be subject to accidental damage, it must be easy to replace.

SIGMA RELAYS ARE FAMOUS FOR:-

- Highest contact pressure per input milliwatt.
- Plug-in mounting.
- Dust-proof or hermetically sealed enclosure.
- Maintenance of precise adjustment.



TYPE 4R

SIGMA
Sigma Instruments, Inc.
Sensitive RELAYS
70 CEYLON ST., BOSTON 21, MASS.

NEW PATENTS

(Continued from page 120)

It will be seen from the modulator diagram shown that an amplitude modulation is superimposed on the frequency modulation by regulating the plate voltage of tubes 16,18 in accordance with the modulating signal. Tubes 26,28 in shunt with resistor 48 in the plate supply of tubes 16,18 are responsible for these plate supply variations. In the receiver, the amplitude modulation is smoothed by a fast acting automatic volume control or by a limiter. The signal, at peak modulation, will be stronger relative to the interfering noise than with conventional frequency modulation only.

J. L. Hathaway, RCA, (F) October 17, 1942, (I) November 7, 1944, No. 2,362,201.

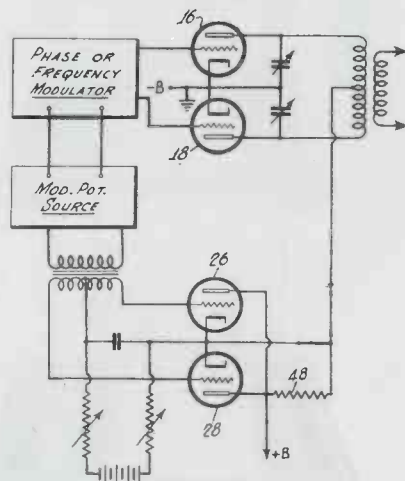

Remote Angle Indicator

It is the object of the invention to provide a radio system for indicating angular movements of one or more pointers at a remote location, that is, a radio system analogous to a selsyn arrangement.

The figure shows the transmitter for indicating the movement of one pointer only, that of pointer 5, which is rigidly connected to a rotatable goniometer coil 7. The stator coils of the goniometer are supplied with quadrature high frequency currents. Consequently, the phase of the voltage induced in the rotatable goniometer coil will be a function of its position and of the position of pointer 5. This voltage is detected and full wave rectification obtained, every other peak is suppressed and by limiting the amplitude a short pulse for every 360 deg. of the low frequency is derived; its phase displacement as compared to the original low frequency voltage is indicative of the pointer position. A carrier wave is modulated by these pulses as well as by the original low frequency signal which is therefore suitable as a reference.

At the receiver, the reference low fre-

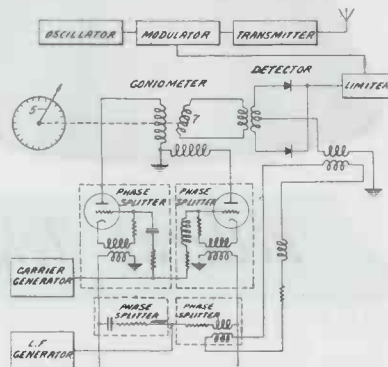

Volume producers of quality crystals



Much of the volume production of quality crystals which North American Philips achieves begins in the saw room, a section of which is shown. Here a battery of high-speed saws of latest design, mounted on vibration-proof concrete bases, cut the quartz into wafers.

This is typical of how North American Philips has applied its techniques of volume production to a highly specialized field where rigid specifications must also be met. More than 50 years of research, development and manufacture in the electrical field form the background of this organization.

Developments to which our research and engineering have contributed include the Q-Lap; the X-ray Quartz Analysis Apparatus; automatic high speed testing for temperature, activity and frequency; and a method for utilizing unfaced quartz.

Today North American Philips is one of the lead-

ing producers of quartz crystals. Although the armed forces have first call on our production facilities, we invite inquiries from manufacturers interested in the utilization of low-cost precision quartz crystals for industrial and commercial applications.

North American Philips offers to such manufacturers the full benefit of its technical resources, engineering facilities and the consultation services of recognized authorities in the crystallographic field. • We invite you to visit our office and showroom when in New York City.

OTHER PRODUCTS: Amplifier, Transmitting, Rectifier and Cathode Ray Tubes; Searchray (Industrial X-ray) Apparatus; X-ray Diffraction Apparatus; Medical X-ray Equipment, Tubes and Accessories; Tungsten and Molybdenum Products; Fine Wire; Diamond Dies.

Norelco Electronic Products by
NORTH AMERICAN PHILIPS COMPANY, INC.

A booklet, "How Quartz Crystals are Manufactured", is available on request.



North American Philips Company, Inc.
 100 East 42nd Street, New York 17, N. Y.

Dept. D-4

Gentlemen:
 Kindly mail booklet, "How Quartz Crystals are Manufactured" to:

Name _____
 Title _____
 Company _____
 Address _____

100 East 42nd Street, New York 17, N. Y.
 Factories in Dobbs Ferry, N. Y.; Mount Vernon, N. Y. (Metalix Div.); Lewiston, Me. (Elmet Div.)



PAPER SHORTAGE POSTPONES MAY ENGINEERING DIRECTORY

The 1945 Engineering Directory of ELECTRONIC INDUSTRIES will not be published in May as originally scheduled. Because of a third cut just announced, either in paper usage or inventory, there is simply not enough paper to go around. Furthermore, an unprecedented demand for advertising space as soon as this issue was announced makes it impossible to arrive at any method of rationing advertising which is fair to everyone. We cannot publish half of what is offered us. The Directory will be published as soon as conditions permit and subscribers will receive a copy as part of their current subscription.

Faced with this situation which makes comparisons of advertising lineage meaningless, and complicated by an inflexible schedule set up by our printer, we must strictly enforce our deadline for all ad copy. Closing date is 1st of preceding month; final deadline the 10th. Late copy is self-rationed and will be omitted. June issue closes May 1st; deadline for final form is May 10th. May we again ask your cooperation in observing these firm dates. Thank you.

CALDWELL-CLEMENTS, INC.
480 Lexington Ave., New York 17, N. Y.

**ELECTRONIC
INDUSTRIES**

Also Publishers of RADIO & Television RETAILING

ELECTRICAL ENGINEER (POWER TUBES)

Nationally known manufacturer of electronic devices has an opening for a junior electrical engineer with power transmission or general radio circuit experience. The work will be to supervise and design circuits for power tube tests and applications.

The work is not of a routine nature and offers a real opportunity for a young, capable and resourceful engineer. Location New York City. Please send sufficient information relative to age, education, experience, and salary desired to warrant an early interview.

BOX 3559

ELECTRONIC INDUSTRIES, 480 Lexington Ave., New York 17, N. Y.

Permanent Magnets

All Shapes, Sizes and Alloys. Alnico magnets cast or sintered under G. E. license. Chrome, Tungsten and Cobalt magnets stamped, formed or cast.

THOMAS & SKINNER
STEEL PRODUCTS CO. • INDIANAPOLIS, IND.
42 YEARS' EXPERIENCE

quency signal is used to provide a circular deflection pattern on a cathode ray tube, while the short pulses cause a radial deflection at a point of the circumference corresponding to the position of pointer 5.

H. G. Busignies, International Standard Electric Corp., (F) March 5, 1941, (I) November 28, 1944, No. 2,363,941.

Spectrophotometer Amplifier

A circuit has been designed for the purpose of recording infrared spectrophotometers. Two thermocouples are used as detectors for the normal beam and the beam transmitted through the test specimen, both being flickering beams. An amplifier, relay and motor combination constitutes the recording unit.

R. L. Hood, American Cyanamid Co., (F) July 31, 1942, (I) October 10, 1944, No. 2,359,734.

Ohmmeter

It was intended to design a stable, rugged ohmmeter covering a wide resistance range. When the resistor R to be tested is inserted as shown, a positive voltage is applied to grid 9 proportional to the ratio of the unknown resistance R to the resistance of either resistor 14, 15 or 16.

Variable resistor 24 is adjusted so that

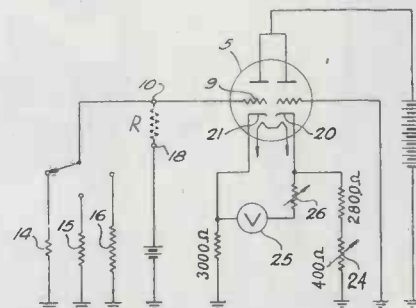

the two cathodes 20 and 21 of the cathode-follower twin-triode tube 5 are at equal potential when no voltage is applied to grid 9. Then, test terminal 10, 18 are shorted and resistor 26 is varied until meter 25 is at full-scale deflection for this condition. A meter 25 drawing from one to eight milliamperes for full scale deflection may be used. The meter deflection with the unknown resistor connected between terminals 10 and 18 will be indicative of its resistance, and the meter scale may be calibrated accordingly.

H. A. Simmons, Western Electric Co., Inc., (F) May 15, 1943, (I) October 17, 1944, No. 2,360,523.

Reactance Tube Circuit

It is intended to produce a large linear frequency swing in a frequency modulator. Tube 12 operates as an oscillator with coil 19 and capacitor 21 as its tank circuit. Tube 11 is the reactance tube.

Due to the autotransformer action of the inductances 19, 20, a larger high frequency voltage appears on plate 30 than on plate 23, and tube 11 represents a larger capacity

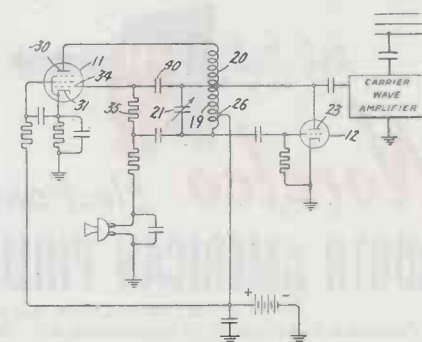

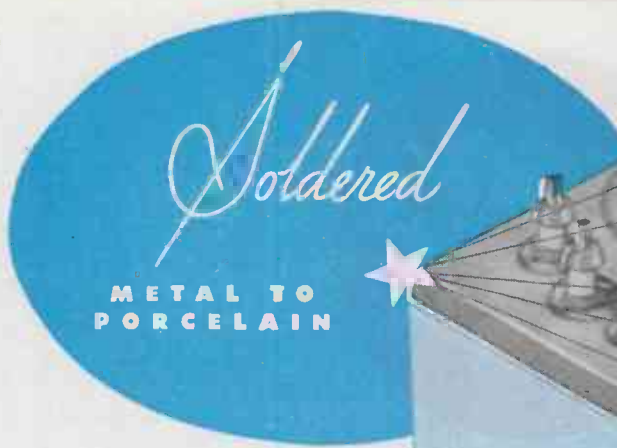

... SOLVED WITH

Solder Seal and Zircon Prestite!

One of the most sensitive electronic assemblies in use by surface and submersible craft entails extremely rigid manufacturing requirements. A multiplicity of leads must be brought out through the cover. Units inside the case must be submerged in oil. Positive, vibration-proof hermetic seals must be maintained at every entrance point, as the slightest leak will cause condensation and failure.

A dual Westinghouse development is solving this problem—more effectively and more dependably than any means previously used.

This development is **SOLDER-SEALING** applied to Westinghouse **PRESTITE** porcelain and **ZIRCON PRESTITE**. Metallic bands, which are an integral part of the porcelain glaze, enable metal terminals and cover to be soldered directly to the porcelain. The result is a 100% hermetic bond between metal and porcelain at every point of contact.

The assembly is tested at pressures of 50 psi and 200° F temperatures. It has proved its ability to withstand any known temperature cycles and conditions of vibration encountered in its class of service.

This application is but one example of the vital part that several millions of Westinghouse **SOLDER-SEALED** bushings are playing in the success of military electronic and communications equipment.

Some of the many standard and semistandard **SOLDER-SEALED** assemblies available to manufacturers are shown in booklet B-3244. Ask for your copy. Westinghouse Electric & Manufacturing Company, P. O. Box 868, Pittsburgh 30, Pa.

T-05157

WHAT IS PRESTITE?

PRESTITE is an exclusive Westinghouse development that combines the high mechanical and dielectric strength of wet-process porcelain with the dimensional fidelity of dry-process porcelain.

PRESTITE is dense, nonporous. Compacting under high pressure and vacuum eliminates minute air pockets, and this minimizes distortion in voltage gradients and eliminates internal corona discharges. Rated L-2.

ZIRCON PRESTITE is a low-loss **PRESTITE** porcelain capable of operating at the ultra-high frequencies of present communications fields. It has exceptionally high mechanical strength and resistance to thermal shock. Rated L-4.



Westinghouse
PLANTS IN 25 CITIES . . . OFFICES EVERYWHERE

**COMMUNICATIONS
EQUIPMENT**

The Standard of Quality
for a Third of a
Century



Volt-Ohm-Milliammeter



All-Purpose Tube and Set Tester



Signal Generators



Oscillograph

ELECTRONIC and RADIO SERVICE Equipment

HICKOK Instruments have long been known as the ultimate in scientific development. Illustrated here are but 4 of our 36 leaders in the Radio Service field. Thousands of Radio Service men have preferred HICKOK Instruments because of their unusual accuracy and dependability. • HICKOK pioneered in Dynamic Mutual Conductance Tube Testing Equipment. In the field of Signal Generators, Tracometers, Vacuum tube Voltmeters, Oscillographs, Zero Current Testers, Volt-ohm-milliam-meters and Industrial Analyzers the name HICKOK is assurance of excellence.

THE HICKOK ELECTRICAL
INSTRUMENT COMPANY
10528 Dupont Ave., Cleveland 8, Ohio

than if the two plates were connected directly. For a carrier frequency of 88.5 kc., a change of about 2 volts in the signal causes a linear frequency deviation of about 5 kc. The total linear frequency deviation thus produced is more than 11 per cent of the average carrier frequency.

In view of the fact that the phase shifting network 35,40 is connected across the entire tank circuit 19,21, and the fact that tap 26 and cathode 31 are maintained at ground potential, the alternating voltage impressed between the control electrode 34 and cathode 31 may be made to differ in phase by exactly 90 deg. from the alternating potential across capacitor 21. Under this condition, amplitude modulation introduced simultaneously with the frequency modulation is minimized.

J. F. Wilcox and E. W. Kenefake, General Electric Co., (F) July 11, 1942, (I) November 28, 1944, No. 2,363,918.

Preventing Blocked Oscillations

In high frequency oscillators in which the operating bias is produced by grid rectification, blocking of the oscillations occurs due to an excessive bias which stops the operation of the oscillator. The excessive bias is gradually reduced and normal operation is resumed. Intermittent oscillations result from such a circuit.

To assure continued operation of the oscillator, capacitor 20 and coil 21 are added. Inductance 18 is sufficiently large to present

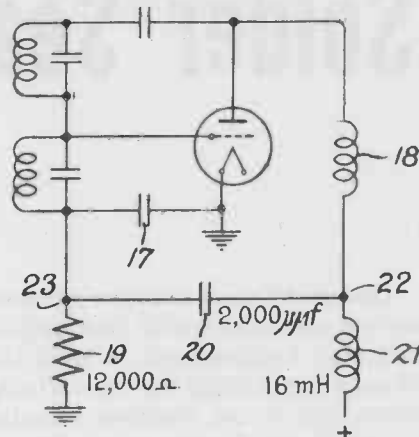

a high reactance to currents of the desired oscillations, while presenting substantially no reactance to currents of the blocking frequency. The inductance 21 is of much higher value, presenting a large reactance to both oscillations. Capacitor 20 is of sufficient capacitance to present a small reactance to the blocking frequency; capacitor 17 has a high reactance at this frequency.

Whenever the circuit tends to block and the bias potential developed across resistor 19 tends to become excessively large, thereby making the control grid so negative as to reduce the current through the tube, the current through inductance 21 is decreased and the potential drop thereacross correspondingly reduced. Consequently, points 22 and 23 will become more positive and the blocking is prevented. The figures on the diagram were used in an oscillator operating at frequencies above 3,000 megacycles.

W. W. Moe, General Electric Co., (F) April 24, 1942, (I) November 21, 1944, No. 2,363,349.

D-C Amplifier

It is attempted to design a two-stage degenerative direct-current amplifier or voltmeter, in which the residual current through the degenerative resistor is balanced out while maximum gain of the separate stages is maintained. Since the current through the degenerative resistor is zero for zero meter reading, its resistance, and consequently the sensitivity of the voltmeter, can be varied over wide limits without affecting the zero setting. If the

THE
HARVEY
OF CAMBRIDGE

REGULATED POWER SUPPLY 106 PA



A Dependable, Controllable
Source of
Laboratory D. C. Power

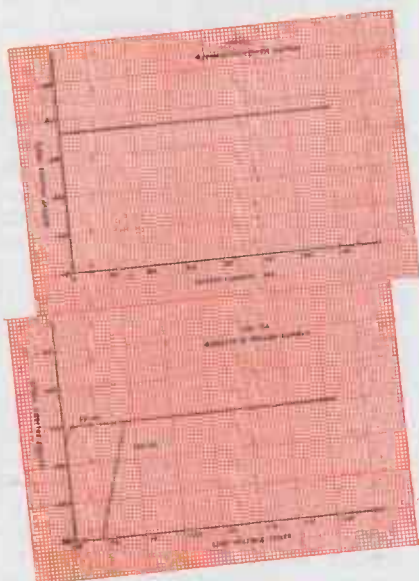

An ideal source of constant voltage for use with pulse generators, amplifiers, measurement equipment, constant frequency oscillators and other equipment requiring regulated D. C. voltage in the 200 to 300 volt range. That is the HARVEY Regulated Power Supply 106 PA.

This precision instrument operates from 115 volts A. C. and has a D. C. voltage output variable from between 200 to 300 volts that is regulated to within one percent. *Output remains constant even though line voltage varies between 95 and 130 volts.*

The HARVEY 106 PA is a model of efficiency and convenience. It has separate fuses on each transformer primary as well as the D. C. output circuit; pilot lights on each switch; and a D. C. voltmeter for measuring output voltage.

For complete information on this efficient, dependable instrument, ask us to send you the HARVEY 106 PA bulletin.

HARVEY
OF CAMBRIDGE

HARVEY RADIO LABORATORIES, INC.

441 CONCORD AVENUE • CAMBRIDGE 38, MASSACHUSETTS

We Have the Following HARD TO GET ITEMS!

TUBES

2X2/879	6AK5	6V6GT	955	VR105/30
5T4	6B8	807	956	VR150/30
6AC7/1852	6H6	954	VR90/30	Many other Nos.

CONDENSERS

OIL-FILLED	MICAS	LARGEST STOCK
BATHTUB	RECTANGULAR	IN EAST

GENERAL RADIO VARIACS—CU 200
 GENERAL RADIO DIAL SCALES
 GENERAL RADIO & KURTZ-KASCH KNOBS— $\frac{1}{4}$ " & $\frac{3}{8}$ " SHAFTS

PANEL METERS—3" and 5" AC Types
 AC VOLTMETERS and AC AMMETERS—Westinghouse
 CIRCUIT BREAKERS—Heineman—All Types

"IDEAL" THERMO-GRIP No. 5 SPOT-WELDERS and SOLDERING PLIERS
 12-VOLT SOLDERING IRONS

IRVOLITE TUBING—Assorted Sizes

RESISTORS—All Wattages and Ohmages
 WARD-LEONARD—RIBFLEX—ETC.

POTENTIOMETERS—Assorted Sizes
 ALLEN-BRADLEY—C.T.C.—ETC.

Write or Wire Today

EMERSON RADIO OF WASHINGTON

SURPLUS MATERIALS DIVISION

1209 13TH ST., N.W.

WASHINGTON 5, D. C.

circuit is used as an amplifier, indicating instrument 33 is disconnected.

Amplifier tubes 2 and 4 provide degenerative feedback across resistor 22. Since tubes 2 and 4 supply the resistor 22 and the instrument 33 with current changes of opposite direction, their operating points may be so chosen that the opposing currents through resistor 22 and indicating instrument 33 balance for the input that is desired to give zero reading.

Another circuit including a diode rectifier, filter, and switching-arrangement combination is also shown which, if connected to the direct current voltmeter, provides an alternating current voltmeter having ranges of 0.3, 1, 3, 10, 30, 100, and 300 volts full-scale.

W. N. Tuttle, General Radio Co., (F) November 8, 1941. (I) August 1, 1944. No. 2,354,718.

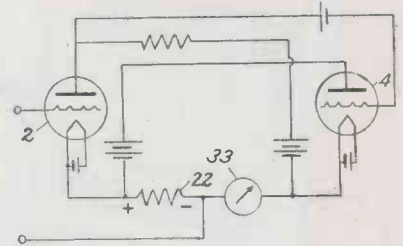

THE VIBRATRON

(Continued from page 80)

the amplifier and bridge network. The Q of the vibrating wire has been built up to the order of 500 or 600 in air and to over 1,000 in a vacuum. This insures that the vibration frequency is entirely dependent on the resonance frequency of the wire.

In this form the Vibratron can be used as an audio frequency oscillator of a continuously variable form having a readily obtainable range of 2:1 (or one octave), the frequency being dependent for any one design, upon the tension in the wire. Its output is quite free from harmonics, less than 1.5 per cent, and can be made substantially so by careful attention to the magnetic field gradient along the wire the field required being strongest, at the center. The ideal field would follow an incremental law, closely that represented by a cosecant curve. A wire $2\frac{1}{2}$ in. long will provide a frequency range of 1200-2400 cycles fundamental. Fig. 3 shows a simple audio oscillator with the frequency controlled by tension adjustments applied by a geared dial. The basic unit, however, appears in many other forms dependent on the particular application. Fig. 4 shows a Vibratron unit of a form that can be built in numerous equipment designs.

In Fig. 2 a Vibratron is illustrated which has the field broken up into four equal sections by four mag-

CARTER DYNAMOTORS

Preferred in World Famous Communications Equipment

THOUSANDS of Carter Products are faithfully providing dependable, efficient service in leading communications equipment all over the globe. Send for latest Catalog of CARTER PRODUCTS Today.

Carter Motor Co.
Chicago, Illinois

1609 MILWAUKEE AVENUE

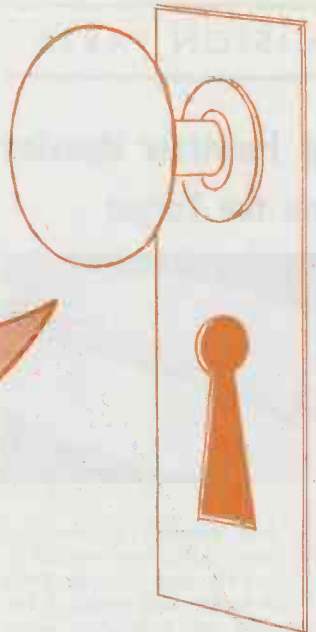

WE'RE THINKING... OF YOUR REPUTATION!

That good name and important position you enjoy in the radio industry took long years to build. Your postwar reputation *can* hinge on the performance of the record changer you select for your radio phonograph combinations of tomorrow.

This is elementary, of course. But it has particular bearing on our postwar concentration on volume production of automatic record changers.

These changers will be Custombuilt. The engineering "savvy" that helped us lick the toughest problems the armed forces could dream up is proving itself right now in the record changers we have designed.

We would welcome your inquiry and design problems. For we are going all the way in this matter of automatic changers. Set manufacturers who knew our prewar changer—who have looked to us for nearly a quarter century for their condensers and other radio components—will understand what this means.

GENERAL **I**NSTRUMENT CORPORATION



829 NEWARK AVENUE • ELIZABETH 3, N. J.

Lobbing Howitzer Heavies on the Target

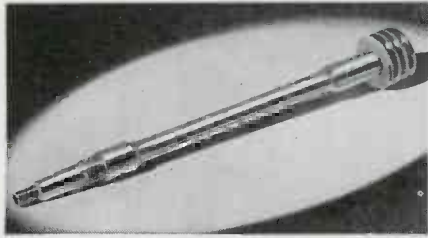

Blasting the way through well-fortified lines calls for heavy ordnance—accurately aimed. Because of the long distances from the guns to the target, any errors in the aiming-mechanism are multiplied many times over.

This worm-shaft is part of the sighting-device on a 105-mm. howitzer. Ace machines and grinds them complete from heat-treated forgings. The worm thread, and the class 3 threads at the small end of the shaft, are ground from the solid. The whole job involves very careful machining and grinding and is typical of Ace facilities and abilities.

Here under one roof you will find competent management and modern equipment well qualified for turning out complete parts and assemblies involving stamping, machining, heat-treating, or grinding. The Ace knack of holding pieces to close tolerances and yet turning them out on a mass-production basis offers many worthwhile advantages. Let us quote on your next job. Send blueprint, sketch, or sample.



FINE PRECISION is yours for the asking.
Keep a copy in your files.



ACE MANUFACTURING CORPORATION
for Precision Parts



1239 E. ERIE AVE., PHILADELPHIA 24, PA.

nets, A, B, C and D. Since the air gap is small it is possible to use permanent magnets or electromagnets here as desired. If all polarities are the same, the wire vibrates at its fundamental mode as at F, the right. If the lower two fields are reversed the wire vibrates at a double frequency, as at 2F, and if alternate fields are reversed a quadrupled frequency results (as at 4F).

The design of the wire suspension is such that the end loading is minimized and the actual frequency found with any set of connections is within a fraction of a cycle from the theoretical true multiple. It is also found that the sharpness of resonance is much higher, the Q of the system rising to about 800 for the second mode (in air) and to around 2,000 for the four mode vibration. This principle is of value in numerous applications since with the use of electromagnets a simple switching arrangement will change the delivered frequencies to a new range at will.

In order to establish a harmonic-free output it has been necessary to limit the amplitude of movement on the wire. This is done quite simply and effectively by the application of AVC to the feedback amplifier. In many applications the amplitude of vibrations is dependent on the inherent properties of the unit, balancing network and the amplifier, all of which are unaffected by the magnitude of the excursions of the item whose movements are being monitored, so that the requirements imposed on the AVC system are not severe.

Displacement converter

Many applications which have found utility make use of the property of converting extremely small movements into a noticeably changed pitch, the latter being measurable with extreme accuracy. A shift of one octave in pitch might mean a movement of around 0.008 in. Simple leverage mechanisms will multiply much smaller displacements to this value quite readily. For example, it has been applied to barometric measurements.

In such work it has the advantage of having substantially the same sensitivity over a wide range of absolute values, provided the receiving system—which is any circuit that will accurately measure audio frequencies — will follow those changes. A change in barometric pressure caused by the change in elevation of 6 in. is measurable with an instrument, such as in Fig. 5, over a wide range of pressures (or altitudes). Here the movement of the diaphragm of a Sylphon bellows is transferred (through a linking mechanism having no lost motion) to the wire, producing a

TECHNICAL NOTES

*Excerpts from New Home Study
Lessons Being Prepared under the
Direction of the CREI Director
of Engineering Texts*

Engineers! Send for This Free Series of Articles on CIRCUIT EQUIVALENTS

Each month CREI presents a specially prepared, practical technical article in its popular magazine, CREI NEWS. The final article on Circuit Equivalents appears in the April issue and discusses the Delta-Wye Transformation with illustrative examples—a Bridged-Tee Variable Attenuation Pad and an I.F. Trap circuit employed in a television receiver.

We believe that the readers of ELECTRONIC INDUSTRIES will find this article of practical interest and possibly of assistance in their daily work.

The CREI NEWS is issued free of charge. Merely write a card or letter and request your copy of the April issue. Your name will be added to the mailing list and you will receive each forthcoming issue together with the interesting series of articles that are planned for the future. We will also be glad to send all past articles on "Circuit Equivalents," if available. Write today—You will incur no obligation in doing so, and you will undoubtedly appreciate its contents.



The subject of "Circuit Equivalents" is but one of many that are being constantly revised and added to CREI lessons by A. Preisman, Director of Engineering Texts, under the personal supervision of CREI President, E. H. Rietzke. CREI home study courses are of college calibre for the professional engineer and technician who recognizes CREI training as a proved program for personal advancement in the field of Radio-Electronics. Complete details of the home study courses sent on request.

Ask for 36-page booklet

CAPITOL RADIO ENGINEERING INSTITUTE

E. H. RIETZKE, President

*Home Study Courses in Practical Radio-
Electronics Engineering for Professional
Self-Improvement*

Dept. EI-4, 3224—16th St., N.W.
WASHINGTON 10, D. C.

Contractors to the U. S. Navy—U. S. Coast
Guard—Canadian Broadcasting Corp.—
Producers of Well-trained Technical Radio-
men for Industry

THEY INCREASE TUBE EFFICIENCY

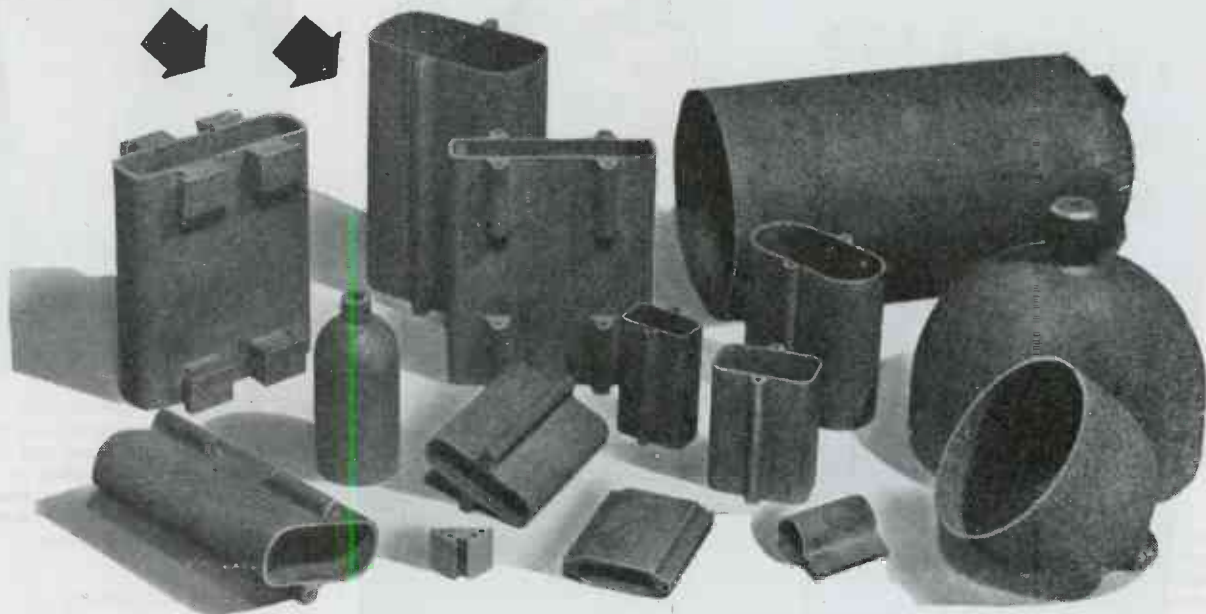

TUBE efficiency depends largely upon the ability of the anode to withstand the rapidity of bombarding electrons under high frequencies and increased power.

Speer Graphite Anodes are manufactured by a method which insures greater plate dissemination—not only of heat but also of power. This process eliminates warping and shrinkage generally brought about by high operating power as well as completely expelling all gases from the anodes.

The uniform operating characteristics of Speer Graphite Anodes remain constant. This permits closely matching of tubes for transmitting and rectifying and achieves efficient performance throughout the life of the tube. Speer Graphite Anodes are available in various designs to conform carefully with standard tube construction. Then too, special anodes can be made to meet special requirements. For high tube efficiency, plus other advantages listed at the right, specify Speer Graphite Anodes.

SPEER GRAPHITE ANODES . . .

- Increase allowable plate power dissipation.
- Lower temperatures of associated tube parts.
- Withstand severe overloads.
- Defy warping.
- Prevent hot spots or fused holes.
- Minimize bulb darkening and insulator leakage.
- Improve degassing qualities.
- Decrease gas troubles.
- Enhance tube appearance.
- Provide precise anode dimensions.
- Produce uniform tube characteristics.
- Retain original dimensions in service.
- Maintain normal tube characteristics.
- Allow wide latitude of anode design.

CHICAGO • CLEVELAND • DETROIT
MILWAUKEE • NEW YORK • PITTSBURGH

SPEER
CARBON COMPANY
ST. MARY'S, PA.

Ⓢ 6532

NEW VACUUM TUBE FREQUENCY METER..

INDICATES
800 CYCLES
± 2 CYCLES!



Model 33-VTF.
with cover removed

Model 33-VTF can be mounted in several ways—rack and panel installation shown is typical. Only the meter appears in front—electronic unit may be mounted either on same panel or at some remote location.

MODEL 33-VTF, now released for commercial use, makes available the ruggedness and exceptional accuracy of the vibrating reed frequency meter. It measures specific bands such as 760-840 cps or 1140-1260 cps.

Again, J-B-T engineers have extended the useful range of the vibrating reed frequency meter—through use of a simple, practical electronic circuit. A vacuum tube multivibrator divides the incoming frequency by the proper integer, and shows the result on the widely used standard 400 cycle meter.

Harmonics of accidental frequencies or unusual wave form do not affect the response where the speed of the inverter or other frequency source is in the approximate range being measured.

Model 39-VTF, Laboratory Type, not shown, has an input impedance of 500,000 ohms, and uses regular line current for power supply. This model, through use of a multiplier switch, measures frequencies 1, 2, 3, 4, 6 and 9 times the basic range of 380-420 cycles.

(Manufactured under Triplet Patents and/or Patents Pending)

J-B-T INSTRUMENTS, INC.

433 CHAPEL STREET • NEW HAVEN 3, CONNECTICUT

Check These Features:

EXTREME ACCURACY... within 0.25% of frequency measured.

PERMANENT ACCURACY... calibrated at factory—no subsequent calibration or standardization required at any time.

STABILITY... no temperature drift after initial 30 second warm-up period. Accuracy is independent of line voltage variation. No voltage regulator, external or internal, is required.

BURN-OUT PROOF... no protection needed against accidental frequencies above the range being measured.

SIMPLE — LIGHTWEIGHT — COMPACT... only 3 tubes—6N7 multivibrator, 6V6 amplifier, 6X5 rectifier. Weighs only 6 lbs.... electronic unit 5½" x 6" x 4⅝"; meter meets JAN-I-6 mounting dimensions for 3½" instruments.

20 WATT POWER CONSUMPTION... derived from frequency source being measured.



ENEMY TUBE?



This could be an enemy tube, but it isn't. It is a copy of a captured tube, made by Bell Telephone Labs in a hurry, and to match the characteristics of the original, so that US invasion forces on the Western Front could put back to work communication facilities wrecked by the Germans in their retreat.

change in frequency.

The tone output is continuous and if necessary to be determined with extreme accuracy it can be compared with a standard over extended periods.

Several of these network Vibratron units, each with its balancing may be employed in succession, as interstage filters in a band pass amplifier, all of the vibrating wires being mounted on the same tension frame. Changes in this tension will tune all the coupling filters with great accuracy to the same frequency. As with the multistage crystal filter unit the selectivity of such a multiple stage filter increases at an exponential rate with the number of stages, and frequency discrimination problems in the audio frequency range can be handled with ease, a great advantage in telemetering installations where great accuracy is needed.

Certain of these uses in the fields of telemetering, remote control and measurements of industrial and communication factors will be taken up in forthcoming issue along with its operational characteristics in greater detail.—R.R.B.

Medal for Jeffries

Dr. Zay Jeffries, of the General Electric Co., Pittsfield, Mass., has been awarded the newly established annual powder metallurgy medal of Stevens Institute of Technology. The medal, which was presented for the first time, is made from powdered metals, and is awarded for "outstanding work in the field of powder metallurgy."



*You can no longer ignore
high frequency heating*

The advantages of electronic high frequency heating have been proved in hundreds of installations . . . but the applications, as yet, are limitless.

Leaders in plastics, ceramics, rubber, textiles and other fields have already adopted **THERMATRON** electronic high frequency heaters for many operations. It may be that **THERMATRON** can also reduce costs, increase production, improve quality in *your* plant. *To learn just what . . .*

Thermatron

ELECTRONIC HIGH FREQUENCY GENERATORS

. . . can do for you, tell us your problem, or submit samples of materials for test purposes. We will tell you, without charge or obligation, whether or not we believe that it will pay you, too, to install **THERMATRON** equipment.

Standard sizes from 500 watts to 30 kilowatts output. Units of special sizes and frequencies built to order. Circular on request, Dept. EI-4

Thermatron Division

RADIO RECEPTOR COMPANY, Inc.

251 WEST 106th STREET

NEW YORK 11, N. Y.

SINCE 1922 IN RADIO AND ELECTRONICS



Every- thing IN SOUND



YOU GET IN A DUPLIX SPEAKER

A smooth 40 cycle low bass response, 15,000 cycles plus in the high frequency range is all any engineer or listener can ask for in high quality sound reproduction. Add a 60 degree angle of horizontal distribution . . . a 40 degree angle of vertical distribution and you have more than you ask for in sound reproduction. You enjoy them all in the Duplex speaker. The SPEAKER that REVOLUTIONIZES the methods of sound REPRODUCTION.

SEND FOR BULLETINS

ALTEC

LANSING CORPORATION

1210 TAFT BLDG., HOLLYWOOD 28, CALIF.

NEW BOOKS

An Introduction to Electronics

By Ralph G. Hudson, Professor of Electrical Engineering, M.I.T., published 1945 by Macmillan Co., New York, 97 pages, illustrated, \$3.00.

This book provides a general survey of what is being accomplished in many fields of activities by the use of electron tubes. It is written in a style that will meet the approval of all those who, although not engineers, are associated with those industries and therefore are expected to know all about everything pertaining thereto. It may also serve admirably to acquaint those who have been "exposed" to some form of electronic work and are interested in discovering enough about the art to decide whether to follow it as a profession.

To the engineer, it is a book that is accurate and authoritative, and one he can recommend to give a clear picture of many devices that have usually been described.

Theory and Applications of Electron Tubes

By Herbert J. Reich, Professor of Electrical Engineering, University of Ill., on leave to the Radio Research Laboratory, Harvard University, published by McGraw-Hill Book Co., New York, N. Y., 1944, 716 pages, \$5.00.

In this edition the whole series of subjects covered by this reference and standard text has been brought up to date by inclusion of a great many of the developments that have appeared during the five years since the first edition appeared. It covers all phases of tube circuit analysis and design and is complete as either a textbook or reference; descriptive material, and illustrations, physical and mathematical analysis, sample problems and many foot-note references.

RCA Profits Grow

The Radio Corporation of America in 1944 reached new peaks in production of radio-electronic equipment vital to the war effort, established new records in radio communications, and completed more than 100 research projects for the Armed Services, it was revealed in the RCA 25th Annual Report. Net profit in 1944 was \$10,263,291, compared with \$10,192,452 in 1943. While the earnings for 1944 are subject to renegotiation, specific provision has been made, therefore, on a basis not materially different from 1943. After payment of preferred dividends, earnings per share of common stock were 51.2 cents, compared with 50.5 cents per share in 1943. Total gross income from all sources amounted to \$326,421,913, compared with \$294,535,362 in 1943, an increase of 10.8 per cent.

AC TIMING MOTOR

Available 450 RPM (or faster) to 1 REV. per month; manufactured to your specific voltage, frequency, speed and torque requirements.



TIME IS PRECIOUS— PLAN TODAY FOR TOMORROW

Timing is vital today—indispensable tomorrow!

Compact, rugged and with extreme flexibility, Haydon timing motors lead the field. Manufactured to your specific voltage, frequency, speed and torque requirements, they are available with brake for instant stop—reversible, and with shift device for automatic reset.

Whatever Your Timing Problems May Be... our timing engineers are ready and willing to help you solve them—Just drop a line to our Timing Engineering Service Department.



DC MOTOR
Reversible—light
compact—light
in weight—7 seg-
ment commutator—
low reactance rotor
winding—alisco field
—totally enclosed.

As makers of the most complete line of Synchronous Timing Motors, Haydon Manufacturing Company offers a complete TIMING ENGINEERING SERVICE

Haydon

MANUFACTURING COMPANY
INCORPORATED

Forestville, Connecticut

No matter how tiny the coil

LUMARITH* C.A.

Keeps the Black Hand
of Corrosion at bay

MANY TYPES of insulation, in the presence of moisture and current, create free acids highly corrosive to current-carrying copper wire. In such instances this electrolytic action is a built-in hazard.

Lumarith C.A. (cellulose acetate base) is chemically inert in electrical applications. It does not give rise to corrosion even on fine copper wire.

Many fabricators use tubing of spiral wound Lumarith C.A. film to make exceptionally strong cores. They are offered by various manufacturers in round, square and oval shapes. Other Lumarith C.A. films are available in plain or in special mat finish (A78) for easier winding. Slippage is reduced, visibility increased.

Lumarith C.A. is also supplied in thin foil for coil linings, coverings and interlayer insulation, and in molding materials for coil spools, bobbins, housings, bases and plugs. Send for the Lumarith Electrical Booklet. Celanese Plastics Corporation, a division of Celanese Corporation of America, 180 Madison Avenue, New York 16, N. Y.



A Celanese Plastic

©1945 U. S. Pat. Off.



DUMONT CAPACITORS

FOR DEPENDABLE RADIO REPAIRS

SOLD ONLY THROUGH
EXCLUSIVE JOBBER
TERRITORIES...

DUMONT ELECTRIC CO.

34 HUBERT ST.

NEW YORK, N. Y.

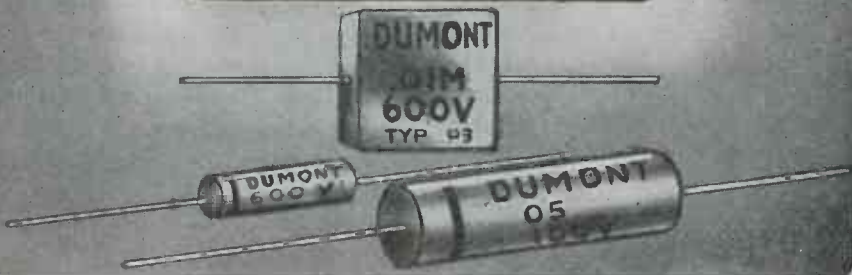

NOTICE: Sales Representatives, Some Territories Open.

NEW BULLETINS

C-R Tube Operation

A new 16-page illustrated booklet on "How & Why Cathode Ray Tubes Work" including a discussion of complete television set-ups, has been made available by North American Philips Co., Inc., 100 East 42nd Street, New York. The text material was written by J. R. Beers, Development Engineer, and is divided into four sections. Early history, mathematical concepts, present-day problems, are treated in Section 1. Schematic diagrams help to convey the idea of how the tube functions. The subject of screens and their characteristics is treated at some length. Section 2 takes up C-R tube manufacturing problems. Curves and pictorial illustrations are used to describe materials, assembly and visual inspection. Testing of C-R tubes is the subject matter of Section 3. Many photos of screen patterns help to identify the wide variety of defects that are enumerated. Section 4 goes into special C-R tube designs. Here complete television set-ups are shown and discussed along with lens systems, color filters and three-color screens.

Electronic Heating

A sixteen page booklet written for both engineer and manufacturer on the subject of electronic heating has been published by Scientific Electric, 107-119 Monroe Street, Garfield, N. J. All essential facts are discussed in a language stripped of confusing terminologies. It contains a brief record of the historical background and development of electronic heating, explains the principle of its operation, describes the two chief methods and fields of application and lists many proved present day uses. Many illustrations are used to make all the important parts of the text easily understood and several types of high frequency generators are shown.

Facsimile Equipment

A descriptive article by Milton Alden of the Alden Products Company of Brockton, Mass., is reproduced and profusely illustrated in a new booklet now being distributed. The author discusses the use and advantages of two kinds of recording paper used in facsimile machines. One, Teledeltos, made by Western Union for their own use, but available to the public is a black conducting paper faced or coated with a light color compound. The current discharge from a fine needle electrode produces a miniature arc and destroys the coating, thus producing a gray to black recording. The other, Alfax, is an

WOKMAR

Manufacturers of
RADIO, ELECTRICAL AND
ELECTRONIC COMPONENTS

ELECTRONIC PRODUCTS MFG. CORP.
DEXTER, MICHIGAN

Still Another DeJUR Achievement

Completely Enclosed ARMY-NAVY Rheostat-Potentiometer

DESIGNED TO CONFORM TO SPECIFICATIONS

JAN. R-22

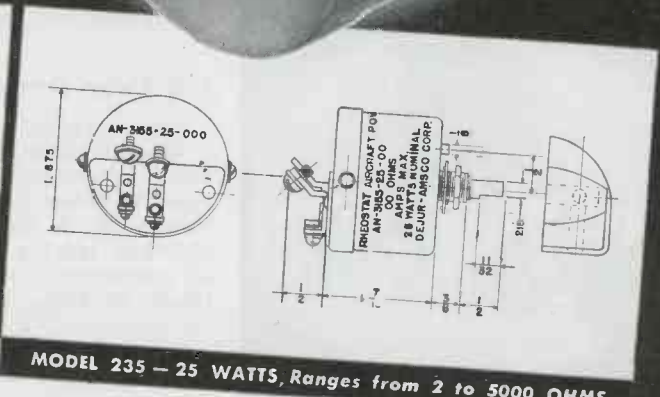
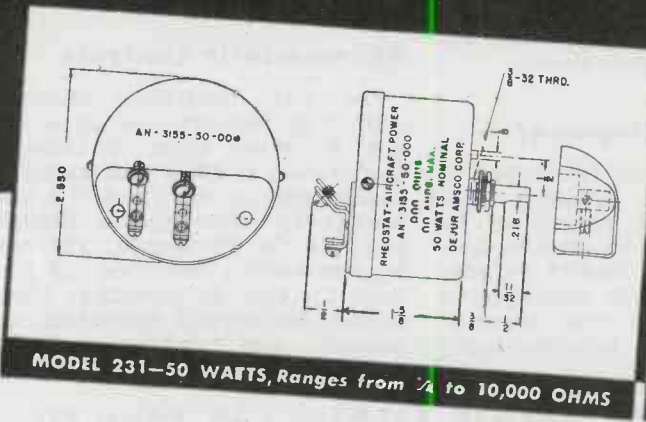
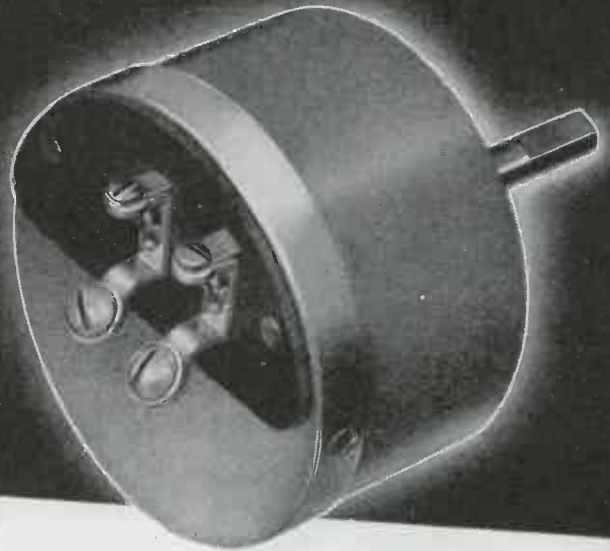

MODEL 231—50 WATTS, Ranges from $\frac{1}{4}$ to 10,000 OHMS

MODEL 235 — 25 WATTS, Ranges from 2 to 5000 OHMS

These two new DeJur rheostat-potentiometers are completely enclosed in permanently sealed, corrosion-proof metal cases. Terminals are brought through a sealed terminal board. Thus, no dust can penetrate, no varying degrees of heat, cold or humidity can affect their high operating efficiency. Rigid requirements, including the salt spray corrosion test, are met.

Supporting these advantages is the excellence of DeJur precision construction. You can subject these instruments to great shock or vibration . . . take them up miles into the air . . . and their close tolerances remain unaffected. Write for additional details, or consult with a DeJur engineer. Special features built to order—length of shaft (round, slotted or flatted) can be provided to individual specifications.

DeJUR-AMSCO CORPORATION

GENERAL OFFICE: NORTHERN BLVD. AT 45th STREET, LONG ISLAND CITY 1, N. Y.
IN CANADA . . . ATLAS RADIO CORP. LTD., 560 KING ST. WEST - TORONTO, CANADA

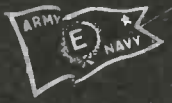

BUY
AND
HOLD
MORE
WAR
BONDS

Designed for



Application



THE No. 90505

SECONDARY FREQUENCY STANDARD

A Precision Frequency Standard for both Laboratory and production uses. Designed around the GE crystal, having a frequency temperature coefficient of less than 1 cycle/Mc/C°. The crystal is sealed in a standard metal tube envelope. Adjustable output provided of intervals of 15, 25, 100, and 1000 KC with magnitude useful to 50 MC. Harmonic amplifier with tuned plate circuit and panel range switch. 800 cycle modulator, with panel control switch. Panel plate supply control switch. In addition to Oscillators, Multi-vibrators, Modulators, and Amplifiers, a built-in Detector with phone jack and gain control on the panel is incorporated. Self-contained AC power supply with VR 150-30 voltage regulator. Cabinet size 9" x 9 5/8" x 10 1/2", weight 20 lbs.

**JAMES MILLEN
MFG. CO., INC.**

MAIN OFFICE AND FACTORY
**MALDEN
MASSACHUSETTS**



electro-sensitive paper with a controlled moisture content. The recorded mark penetrates clear through which makes it adaptable for blue printing and other processes. Problems of speed and synchronism are discussed, as is the influence of size of recording on adaptability to general use. Illustrations show not only various models of facsimile machines, but also samples of results obtained. The back page is illustrated with sockets, connectors and other company products.

Power Connectors

A new 52 page catalog of power connections for electronic equipment has been issued by Harvey Hubbell, Inc., Bridgeport, Conn. The book lists a great variety of regular and midget connectors in two, three and four-wire types, plugs and receptacles, indoor and outdoor wall plates, convenience switches and a host of other attachments for power lines.

CR Tube Development

"Time, Tubes and Television," is a 48-page booklet including four-color illustrations, distributed by Allen B. DuMont Laboratories, Inc., Passaic, N. J. The booklet includes sketches tracing the development of communications from primeval times to 1945. It presents high-

lights in the development of the cathode-ray tube, traces the various production steps through which modern cathode-ray tubes pass in the process of manufacturing and shows dozens of its applications. Applications of the oscillograph, cyclograph and television tubes are described and the book is illustrated with photographs of equipment and television programs.

Resistor Color Charts

Stackpole Carbon Co., St. Marys, Penna., has prepared for free distribution new resistor color code indicators. Of handy, vest pocket size, these contain complete information on resistor color coding under the American war standard specifications as well as the joint Army-Navy specifications, both being identical with the RMA (Radio Manufacturers' Association) set-up. The Color Code Charts are printed on heavy varnished cards.

Thermostatic Controls

For safe, accurate, automatic control of temperatures up to 650 deg. F., seven types of bi-metal thermostats to fill a wide range of applications are described in a new booklet by Westinghouse Electric and Mfg. Co., Pittsburgh. The new 20-page booklet describes and pictures the Built-in-watchman thermostat, for aircraft equipment, instrument and bandage sterilizers,

WAR BORNE WALKIE TALKIES CAN TAKE IT!

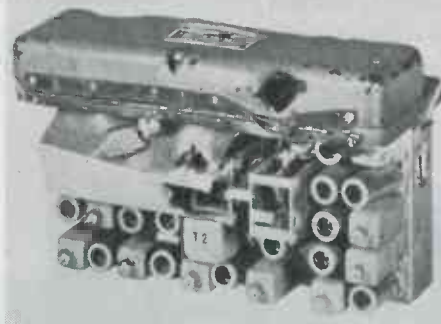
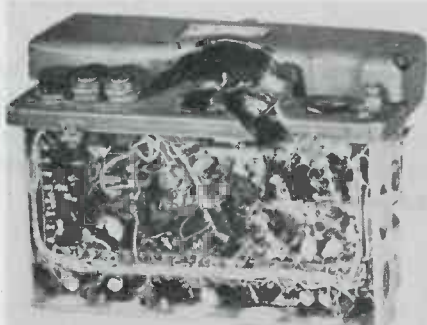

No, dear reader, the Walkie Talkie shown in these pictures did not survive the enemy assault that put a couple of 30-30 bullets through it—Galvin Mfg. Co., makes the units pretty rugged but not to take the abuse that this one, picked up by Major General W. H. Harrison on the battlefield at St. Lo, has assimilated. One picture shows how the equipment looked originally

ARE YOU USING THE TUBING
best SUITED FOR YOUR JOB ?

Irvington

can Supply it

BEST suited means a varnished tubing or sleeving that meets every service requirement . . . at lowest cost!

That's the way IRVINGTON . . . long the leader in electrical insulation . . . meets every tubing or sleeving need. For IRVINGTON makes *all* the types including non-fraying FIBERGLAS . . . high voltage IRV-O-VOLT . . . RADIO SPAGHETTI and SATURATED SLEEVINGS . . . in a complete range of colors and A. S. T. M. sizes.

Thus a recommendation from IRVINGTON can be unbiased . . . you get the tubing *best* suited to your needs, not only from the standpoint of efficiency, but economy as well.

In addition, you get that extra increment of electrical surety which IRVINGTON'S 'know how' and 'manufacturing control' provides. For literature, or engineering assistance, write to Dept. 50.

IRVINGTON PRODUCTS:

Cotton, Fiberglas, or Rayon Tubings and Sleevings — Varnished, Lacquered, or Vinylite Processed

Non-Fraying Fiberglas Sleeving

Transformer Lead Tubings

Wire Identification Markers—Varnished or Plastic

Extruded Plastic Tubings

Fibron Plastic Tapes

Varnished Fabrics and Papers

Slot Insulations

Harvel and Irvington Insulating Varnishes

Cardolite Resins

"LOOK TO IRVINGTON
FOR CONTINUED
LEADERSHIP IN
INSULATION"



IRVINGTON
VARNISH & INSULATOR COMPANY

Irvington 11, New Jersey

**WE
DELIVER
THE
GOODS!**



10,000 PARTS immediately available on priorities.

SAME-DAY SERVICE

Trained expeditors fill your order the day we receive it.

SINCE 1922 we have been known as reliable and responsible jobbers, wholesalers and manufacturers, of radio and electronic equipment.

**Radio Wire
Television Inc.**

100 SIXTH AVE., DEPT. N-4 NEW YORK 13, N. Y.
BOSTON, MASS. • NEWARK, N. J.

WORLD'S LARGEST
RADIO SUPPLY HOUSE

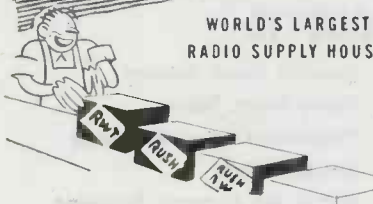

Originators and
Peacetime Marketers
of the celebrated

Lafayette Radio

Write today for our bargain flyers and special bulletins.

motor and wiring protection, vulcanizers, radio equipment, oil purifiers and flat-irons; the Closetemp thermostat, for applications where space is limited such as in platens, irons and vulcanizers; Uni-Therm thermostat, combining close control with small size and simple, compact mounting; the Sentinel thermostat, for roasters, water heaters, dehydrators and casseroles; Guardsman thermostat, particularly designed for sealing machines, ironing machines and other low-wattage heating applications; Water Heater thermostat, for domestic storage type heaters; and the Motorguard, for use on fractional and integral horsepower motors. Characteristics and capacities for each unit are tabled and cross sections, curve and drawings illustrate operation and proper mounting of units.

Test Equipment

A new bulletin F issued by the Shallcross Mfg. Co., Collingdale, Pa., describes several forms of high-voltage test equipment. These include portable kilovolt-meters suitable for use from 1 to 30 kilovolts as well as corona protected kilovoltmeters for measurements up to 200 kilovolts. Separate kilovolt-meter multipliers are available for use with external meters for measurements from 1 to 30 kilovolts; corona protected resistors are available separately for use with suitable meters to permit measurements of potentials up to 200 kilovolts.

Speech Problems

Number 4 in its series of technical monographs entitled "Effective Reproduction of Speech" has been issued by Jensen Radio Mfg. Co., 6601 South Laramie Ave., Chicago. The booklet of 16 pages is concerned mainly with the physical characteristics of speech which are important in the design of systems and components for its transmission and reproduction. The book is an engineering treatise on the subject and contains a great amount of carefully compiled and valuable data.

Fastener Manual

The manufacturers of Camloc Fasteners have issued a new service manual (44-C.) describing the various service operations of the Camloc fastener 4002 Series. Cartoons by Crawford Young illustrate in a simple way, procedure to be followed in replacing any type fastener. A complete maintenance parts list is also included. Camloc Fastener Corp., 420 Lexington Avenue, New York 17, N. Y., or 5410 Wilshire Boulevard, Los Angeles 36, Calif., is the maker.



**A compact unit
for clarity in
VOICE
REPRODUCTION**



**University
HIGH-EFFICIENCY
ANNOUNCING SPEAKERS**

This unit specially designed for voice reproduction—has greater capacity than any speaker of comparable size. It is particularly recommended for paging and announcing applications. Available in two types, 1B8 and 1BR for 60° and radial dispersion with capacities of 12 and 10 watts respectively. Frequency response 300 to 5000 cycles. Diameter of both units only 9". Both are water proof, shock proof and will operate continuously outdoors under severest climatic conditions. Hermetically sealed driver units and swivel mounting bracket are standard equipment on 1B8 and 1BR speakers. Write today for complete information and technical data on all UNIVERSITY projectors, loudspeakers and driver units.



**UNIVERSITY
LABORATORIES**
225 VARICK STREET
NEW YORK 14, N. Y.



KAAR 50 and 100 WATT INSTANT HEATING MOBILE OR FIXED RADIOTELEPHONES

A new series of KAAR radiotelephones, offering improved performance and greater convenience, is now available to police and fire departments, public utilities, sheriffs' offices, railroads, the forestry service, and similar users of radiotelephone communication. Designed with the needs of these services in mind, this series provides instant heating tubes, single channel or five channel operation, and crystal controlled or tunable receivers. Notice how compact this equipment is, and how it is immediately accessible for tuning or servicing, although the cabinet itself may be permanently secured to a shelf, wall, vehicle, or vessel.

SERIES 46 • 50 WATT KAAR RADIOTELEPHONE

A five channel transmitter with power output of 50 watts. All five channels are independently tuned, and any one may be instantly selected by turning a knob on the front panel. Standard frequency range is from 1600 to 6000 Kc. Furnished with companion tunable or fixed tuned crystal-controlled receiver as desired. Power supply (8"x8"x17") is a separate unit, interconnected by a 12-foot cable. Available for operation on 117 volts 60 cycle A. C., 12, 32 and 110 volts D. C.

SERIES 96 • 100 WATT KAAR RADIOTELEPHONE

(NOT ILLUSTRATED)

Five channel instant-heating transmitter, with an output of 100 watts and having a standard frequency range from 1600 to 6000 Kc. The companion receiver may be of the tunable or fixed tuned crystal-controlled type as desired. R. F. ammeter and plate milliammeter are mounted on front panel. This 100 watt radiotelephone, including transmitter and receiver, is only 19½" high, 22" wide, 14¾" deep. Furnished with separate power supply (8" high, 16" wide, and 17" deep). Available for operation on 117 volt 60 cycle A.C., 32 or 110 volt D.C. circuits.



KAAR ENGINEERING CO.

PALO ALTO • CALIFORNIA

Export Agents: FRAZAR & HANSEN, San Francisco



COMPARE THE ADVANTAGES ... and you will get a KAAR 46!



★ **INSTANT HEATING TUBES...** Stand-by current is zero—yet there is no waiting for tubes to warm up before sending a message! Reduces drain on batteries . . . extremely important in mobile or marine operation.



★ **FIVE CHANNEL TRANSMISSION...** Any one of five channels from 1600 to 6000 Kc can be instantly selected by turning the large knob on the panel.



★ **CARRY ONLY 1 SPARE TUBE...** For simplicity of replacement there is only one type of tube used in these Kaar transmitters. (For 117 volt AC operation, 5R4GY rectifier tubes are also employed.)



★ **REMOVABLE PANEL...** By removing six finger-tight lugs, the front panel of the transmitter may be lifted away, exposing all tuning controls. This allows complete tune-up to be made in a short time without moving the set.



★ **SIMPLE TO SERVICE...** When four screws are released, transmitter slides out like a letter file to simplify tube replacement.



★ **FITS MOST ANYWHERE...** Transmitter may be placed above or below the receiver, or on either side of it. Transmitter and receiver units are each 10" high, 13" wide, 13" deep. This equipment is easy to install.



★ **REASONABLY PRICED...** Although Kaar instant-heating radiotelephones offer all these features for convenience and simplicity, they are competitively priced. Your inquiries are cordially invited.

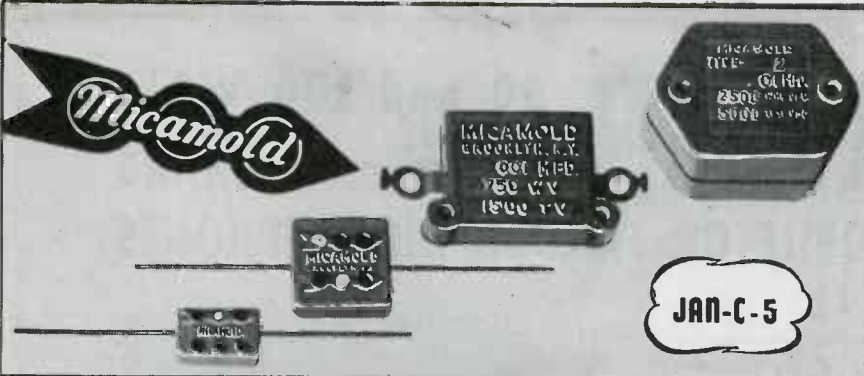

FIXED MICA DIELECTRIC CAPACITORS

JAN-C SPECIFICATIONS are called for on new Government contracts. MICAMOLD is supplying, in production quantities, the many required types in conformance with JAN C-5 specification.

Also—We can supply you with: Fixed Paper Dielectric (non-metallic cases); Fixed Paper Dielectric (hermetically sealed in metallic cases); Dry Electrolytic Polarized; Ceramic Dielectric fixed (temperature compensating)

CONFORMING RIGIDLY TO JAN SPECIFICATIONS

MICAMOLD Radio Corporation
115 Knickerbocker Ave., Brooklyn 6, N. Y.

PERSONNEL

Dr. C. B. Jolliffe, chief engineer of the RCA Victor Division, has been elected vice president of Radio Corporation of America in Charge of RCA Laboratories. Dr. Jolliffe will succeed Otto S. Schairer, who was elected staff vice president of RCA. Mr. Schairer will be consultant and advisor on matters pertaining to research, development, patents, trademarks, and licenses.

A native of Morgantown, West Virginia, Dr. Jolliffe was graduated from West Virginia University with a B.Sc. degree in 1915 and received



Dr. C. B. Jolliffe, newly elected vice-president of RCA, in charge of Princeton Laboratories

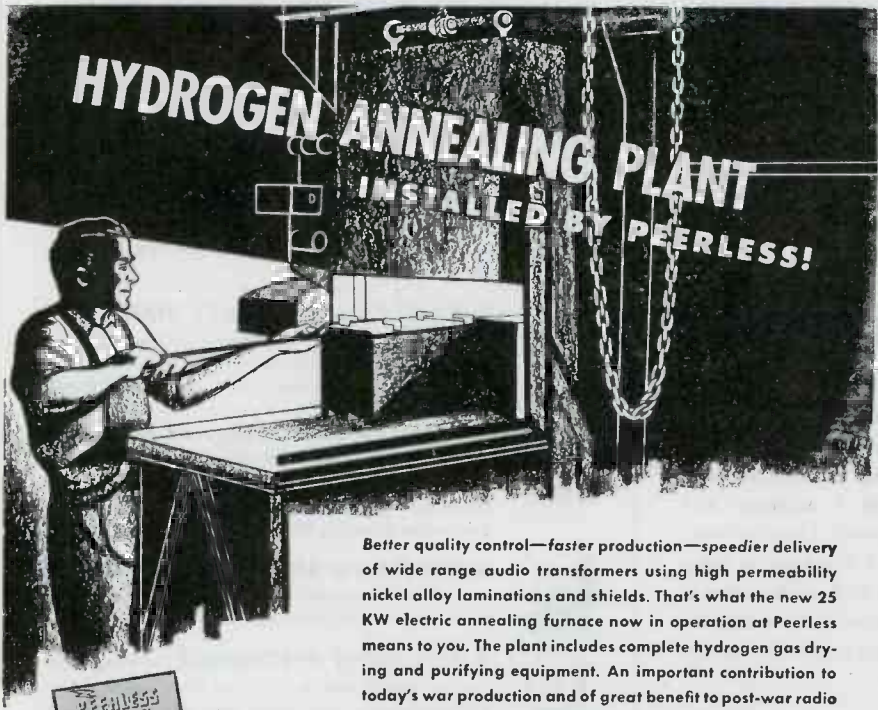

HYDROGEN ANNEALING PLANT INSTALLED BY PEERLESS!

Better quality control—faster production—speedier delivery of wide range audio transformers using high permeability nickel alloy laminations and shields. That's what the new 25 KW electric annealing furnace now in operation at Peerless means to you. The plant includes complete hydrogen gas drying and purifying equipment. An important contribution to today's war production and of great benefit to post-war radio manufacturers of FM, television and geophysical equipment.



Write today for new transformer catalog.



PEERLESS
ELECTRICAL PRODUCTS CO.

the M.S. degree in 1920. He was awarded the Ph.D. in 1922 at Cornell University, where he was instructor in physics from 1920 to 1922. His Alma Mater conferred the honorary degree of LL.D. in 1942.

From 1922 to 1930, Dr. Jolliffe served as physicist in the radio section of the Bureau of Standards, resigning to become chief engineer of the Federal Radio Commission. He remained for five years with the FRC and its successor, the Federal Communications Commission, and then joined the Radio Corporation of America as engineer-in-charge of the RCA Frequency Bureau. In 1941, he was appointed chief engineer of RCA Laboratories, and early in 1942 he was made Assistant to the President of RCA.

Joyce Leaves RCA

Tom Joyce, general manager of the radio, phonograph and television department of the RCA Victor Division of the Radio Corporation of America, Camden, N. J., who has resigned after 23 years of service, has not announced future plans.

Mr. Joyce is recognized as an

THYRATRON WL-678
Grid Controlled Mercury Vapor Rectifier

General Characteristics

	55° C Max. Thg	50° C Max. Thg
Filament Voltage	5.0 Volts	5.0 Volts
Filament Current	7.5 Amperes	7.5 Amperes
Filament Heating Time (Minimum)	1 Minute	1 Minute
Typical Control Bias at Rated Voltage	-50 Volts	-75 Volts
Maximum Ratings		
Anode Voltage, Peak Forward	10000	15000
Anode Voltage, Peak Inverse	10000	15000
Anode Current, Average	1.6 Amperes	1.6 Amperes
Anode Current, Peak	6 Amperes	6 Amperes
Temperature Range, Condensed Mercury	25 to 55° C	25 to 50° C

THIS NEW

15,000 VOLT

THYRATRON

**provides split-cycle control of high power
for R. F. heating units, and radio transmitters**

The WL-678 combines the high voltage characteristics of a Kenotron, the efficiency of a Phanotron, and the controlability of a Thyatron. This latest feat of Westinghouse engineering offers the electronic equipment designer the following outstanding advantages:

- Smooth and instantaneous power control from 0% to 100% load . . .
- Simplified automatic load control . . .
- High speed automatic overload protection . . .
- Low space and weight requirements . . .
- Low control power requirements . . .

For more detailed information—write to your nearest Westinghouse office or to Westinghouse Electric and Manufacturing Company, Lamp Division, Bloomfield, N. J. Westinghouse Electronic Tube distributors are located in principal cities.

Westinghouse
PLANTS IN 25 CITIES OFFICES EVERYWHERE

Quality Controlled Electronic Tubes

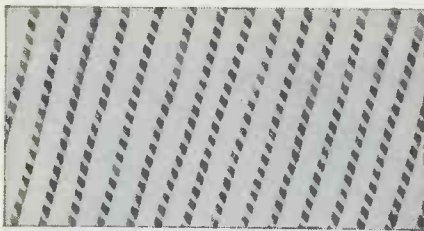

SURCO-AMERICAN New THINWALL WRAP

PLASTIC INSULATED FINE WIRE

UNBELIEVABLY THIN

- Maximum saving of space and weight
- Unlimited identification
- Reduced heating factor

EXAMPLE:

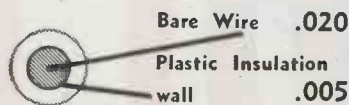

Outside diameter including THINWALL WRAP .036

Surco-American Thinwall Wrap is the first fine wire, plastic insulated, and cotton wrapped to occupy such a small space. Here within 36/1000 of an inch are all of the advantages you could ask of an insulated wire: low heating and cold factors, better operating temperatures, abrasion resistance, soldering iron protection, the widest range of identification, with minimum weight and space. Write for complete information.

Surprenant
ELECTRICAL INSULATION CO.

Dept. O

84 Purchase St., Boston 10, Mass.



authority on the postwar commercial development of both home and theater television. His work in this field is recognized by the industry as a leading factor in the upsurge of interest and activity in television during the past year and a half. His contributions to RCA received recognition when, at the age of 29, he was made manager of advertising and sales promotion for all of the company's products, both domestic and export. Four years later, he was elected a vice-president of the RCA Mfg. Co., predecessor to the RCA Victor Division.



Tom Joyce, long-time RCA Victor Division executive, severs his connection after 23 years

In these capacities, Mr. Joyce was responsible for a number of promotions and developments of far-reaching effect: The sealed radio tube carton, on which he was granted a U.S. patent, was the basis for a sales and advertising campaign which effectively stamped out the "racket" of selling used radio tubes as new tubes; the famous advertising and sales campaigns built around the "Magic Brain," "Magic Eye," "Magic Voice" and "Electric Tuning—Push a Button, There's your station"; and for the highly successful exploitation of the RCA Victor personal radio.

Along with Edward W. Wallerstein, now President of the Columbia Recording Corporation, Mr. Joyce was one of the first to foresee and predict the remarkable come-back of recorded music. He supervised the development of a vigorous advertising, promotion and publicity campaign which played a large part in boosting industry record sales from ten million in 1934 to more than one hundred million today.

Arthur C. Omberg has been made chief research engineer of the Bendix Radio division of Bendix Aviation Corporation, Baltimore. Formerly assistant chief of the operational research branch of the

BIRD & CO. GLASS INSTRUMENT BEARINGS

GLASS "V" BEARINGS
made to your specifications



We welcome your inquiries

RICHARD H. BIRD

Manufacturers of Jewel Bearings
for thirty years

23 MOODY STREET
WALTHAM, MASS.

JONES 500 SERIES PLUGS and SOCKETS

(Heavy Duty)



P-506-CE



S-506-DB

Designed for 5000 Volts and 25 amperes per contact. Socket Contacts of phosphor bronze, knife-switch type, silver plated. Plug Contacts are of hard brass, silver plated. Made in 2, 4, 6, 8, 10 and 12 Contacts.

All Plugs and Sockets are Polarized. Long leakage path from Terminal to Terminal and Terminal to ground. Caps and Brackets are of steel, parkerized. Plug and Socket blocks interchangeable in Caps and Brackets. This series is designed for heavy duty electrical work and will withstand severest type of service.

Write for Bulletin No. 500 describing this line of Heavy Duty Plugs and Sockets.

HOWARD B. JONES COMPANY
2460 W. GEORGE ST. CHICAGO 18

What type of microphone is best suited for a particular application?

How can I convert the level of a microphone rated on the basis of milliwatts per bar to a level of volts per bar?

What new types of special purpose microphones have been developed for voice and sound transmission?

These and many other answers may be found in the
NEW and COMPLETE *Electro-Voice* CATALOG

More than an exposition of microphone types, the new Electro-Voice Catalog provides a source of valuable information which should be at the fingertips of every sound man. It contains a simplified Reference Level Conversion Chart which marks the first attempt in the history of the industry to standardize microphone ratings. Several pages are devoted to showing basic operating principles of microphones . . . offering a guide to the proper selection of types for specific applications. And, of course, every microphone in the Electro-Voice line is completely described, from applications to specifications.

*Reserve your copy of the new
Electro-Voice Catalog. Write today.*

BUY AND
HOLD
MORE
WAR
BONDS

***Electro-Voice* MICROPHONES**

ELECTRO-VOICE CORPORATION • 1239 SOUTH BEND AVENUE • SOUTH BEND 24, INDIANA
Export Division: 13 East 40th Street, New York 16, N. Y., U. S. A. Cables: Arlab



MODEL 201



The Time-Tested, Reliable **VIBROTEST**

Insulation Resistance Tester

Since 1938 VIBROTESTS have proven the soundness of this modern method of testing insulation resistance. Superbly engineered, ruggedly built, this pioneer instrument in CRANKLESS INSULATION TESTING offers the utmost in usefulness and value.

VIBROTEST

Is Thoroughly Modern —

No handcranking, no leveling, no shocks to the operator. Wide range of 0-200 megohms covering values usually encountered in general testing are instantly available from a self-contained power service providing a constant potential of 500 volts DC.

Available in this one compact instrument are a convenient ohm-meter scale, as well as AC and DC voltage ranges of 150-300-600 volts full scale, which covers all testing problems usually encountered in industry.

Many Other VIBROTESTS

are designed for specific uses involving unusual ranges of operating conditions. WRITE for full information at your earliest opportunity.

Engineering Service Representatives in
all Principal Cities

ASSOCIATED 
RESEARCH
Incorporated

221-B So. Green Street • Chicago 7, Ill.



Arthur C. Ohmberg, who becomes chief research engineer for Bendix Radio, Baltimore

U. S. Army Signal Corps, he will be responsible for all Bendix Radio long term product development and electronic research in radio, radar and television, Webb stated. Also appointed was Dr. Harold Goldberg, formerly senior engineer with the Stromberg-Carlson Co., as a research engineer of the Bendix Radio staff. Dr. Goldberg is a graduate of the University of Wisconsin, where he was a Post-Doctorate Fellow in biophysics, research and electro-physiology.

Edison-Splitdorf Corp., a division of Thomas A. Edison, Inc., has appointed Gustave D. Cerf chief engineer of that subsidiary. Mr. Cerf has been with Edison-Splitdorf for more than five years in the capacity of assistant chief engineer and fills the position made vacant by the resignation of E. B. Nowosielski. Previous to his affiliation with Edison-Splitdorf Corp., Mr. Cerf was with the Scintilla Magneto Corp. for ten years.



Gustave D. Cerf, recently made chief engineer of Edison-Splitdorf Corp., Inc.

MECHANICAL ENGINEERS

POWER TUBES

New York City laboratory of national electronic manufacturing concern has a position for a mechanical engineer who has general tool knowledge and working knowledge of impact on cantilever structures to supervise the mechanical design of power tubes.

The engineer for this position should have experience with scientific apparatus design or small machine drafting experience. Any experience in the manufacture of power tubes will be particularly valuable.

This opening will demand the best in initiative and ability and should prove to be an excellent stepping-stone in the career of an ambitious engineer.

Please reply giving age, education, experience, and salary desired to

BOX 3537

ELECTRONIC INDUSTRIES

480 Lexington Ave., New York 17, N. Y.

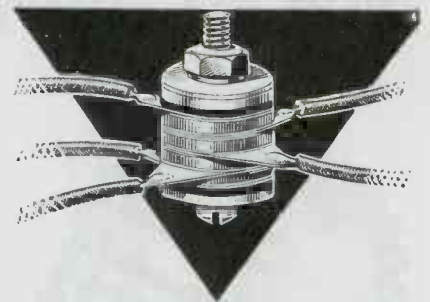

ELECTROX

Low-Capacity

RECTIFIERS

Full-wave and half-wave copper-oxide rectifiers for instruments, test-sets and similar applications. Supplied, since 1930, to leading manufacturers.



Write for illustrated
Bulletin 446.

SCHAUER MACHINE COMPANY
2077 READING RD., CINCINNATI 2, OHIO

ELECTRONIC INDUSTRIES • April, 1945

Why **OHMITE** Resistors PERFORM SO DEPENDABLY

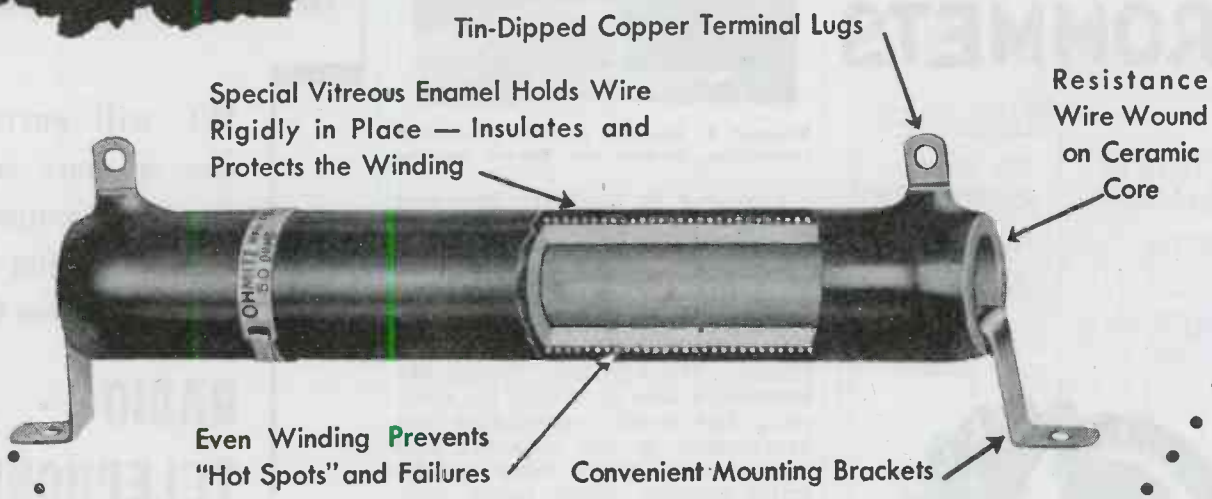

Here you see a few of the important features that insure long life and trouble-free service in every Ohmite Resistor. In the lug type illustrated above, the resistance wire is both mechanically locked and brazed to copper terminal lugs to assure perfect electrical connection. Time-proved Ohmite vitreous enamel construction dissipates heat rapidly . . . withstands humidity. Today, Ohmite Resistors are extensively used in the Armed Forces, Industry, Communications, Research. *Made in a wide range of types and sizes in stock and special units for every need. Consult Ohmite engineers on your resistor problem.*

OHMITE MANUFACTURING COMPANY
4984 FLOURNOY ST., CHICAGO 44, U. S. A.



Write on company letter-head for Industrial Catalog and Engineering Manual No. 40. Gives helpful information on resistors, rheostats, chokes, tap switches.

Be Right with **OHMITE** RHEOSTATS • RESISTORS • TAP SWITCHES

NOW 8 SIZES OF CREATIVE GROMMETS

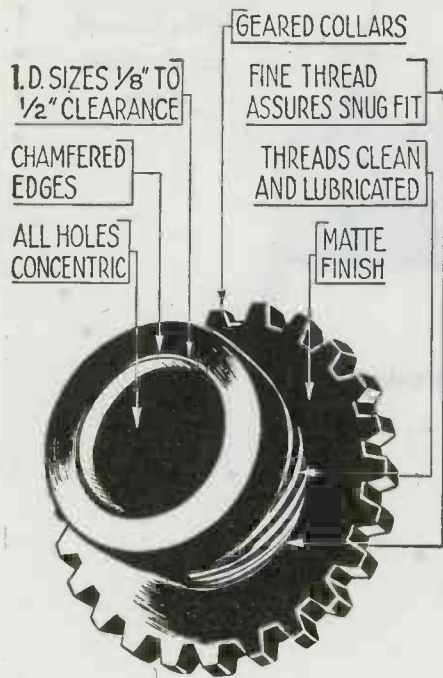

Four additional larger sizes of CREATIVE GROMMETS (up to $\frac{1}{2}$ " inside diameter) are now available to manufacturers and assemblers of radio, electronic and electrical instruments.

Here's a quick way to determine how the above seven basic advantages of these 100% phenolic plastic grommets can improve your assembly.

Send for our new free sample card containing all eight standard sizes.

Creative
PLASTICS CORP.
968 KENT AVE. BROOKLYN 5, NEW YORK



Raymond R. Machlett, president of Machlett Laboratories, honored with Stevens medallion

Raymond R. Machlett, President of Machlett Laboratories, Inc., Springdale, Conn., largest producer of X-ray tubes, was honored at an alumni dinner of the Stevens Institute of Technology with the Honor Award medallion of the Institute. The citation: "Under Mr. Machlett's able direction, his company has made outstanding improvements in the structure and operation of X-ray tubes, specifically rotating anode tubes, malleable berillium for X-ray tube windows, X-ray tubes for defraction analysis and, lately, a super X-ray tube, the first commercial tube to operate at two million volts. During the war years Mr. Machlett's company, in addition to its X-ray tube manufacture, has been engaged in the manufacture of electronic tubes for special military purposes, including radar tubes.

H. Z. Benton has joined the engineering staff of American Phenolic Corp., 1830 South 54th Avenue, Chicago, to be in charge of design and



H. Z. Benton who has joined engineering staff of American Phenolic Corp.

This is IMPORTANT to 5 MANUFACTURERS

WE will purchase one or more equipment or component manufacturing businesses in these fields

**RADIO
TELEPHONE
TELEGRAPH
TELEVISION
WIRE PHOTO
SOUND on FILM**

OR we will purchase only a particular Department. In either case we will assume responsibility for servicing equipment now in use.

All answers will be held confidential.

Please Reply to BOX A-27

ELECTRONIC INDUSTRIES
480 Lexington Avenue, New York 17, N. Y.

(The publisher is authorized to furnish our name if written request is made on your company letterhead.)

ELECTRONIC INDUSTRIES • April, 1945

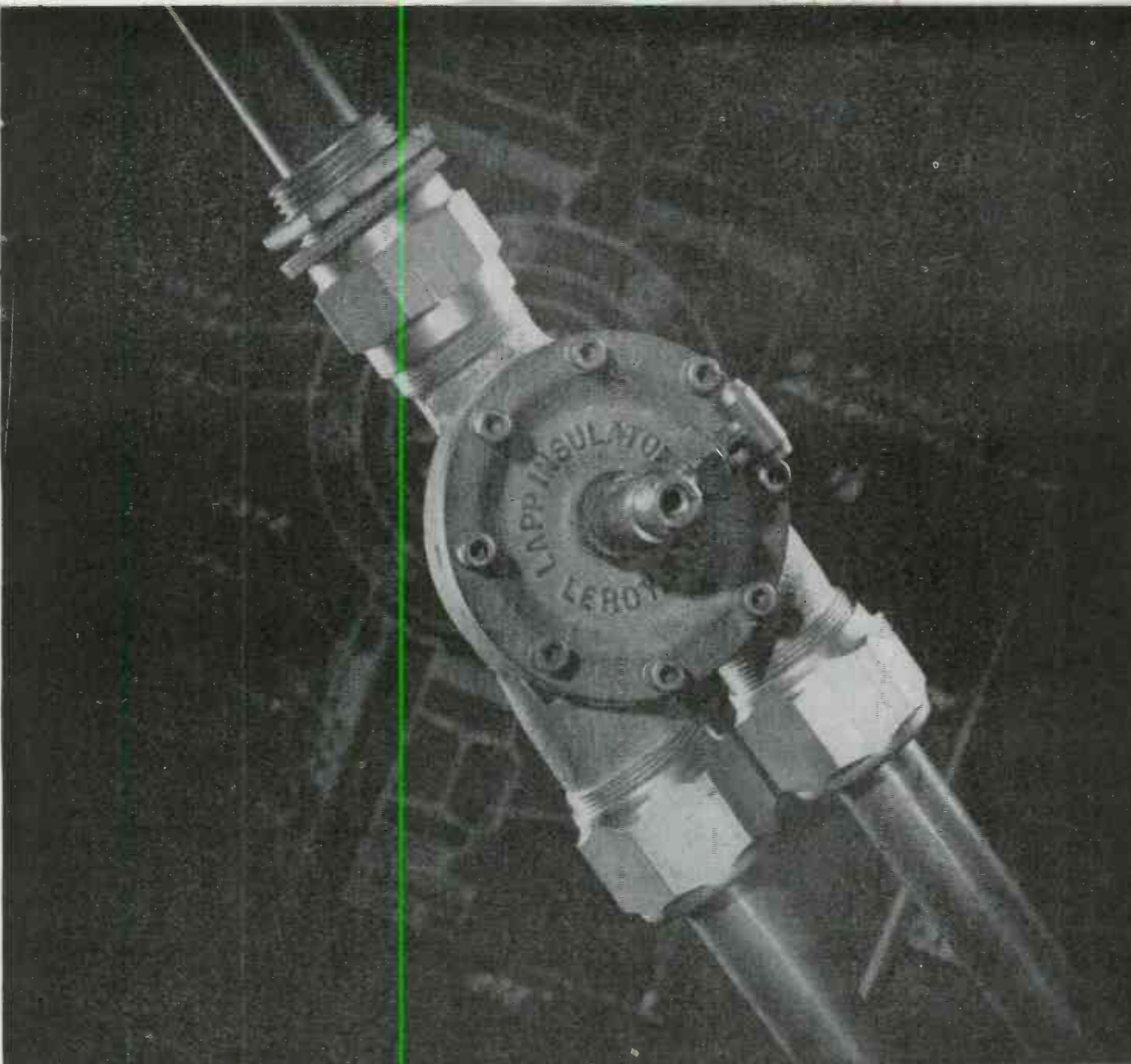

Electronic Parts : ENGINEERING AND PRODUCTION

The gadget above is a junction box for a co-axial gas-filled transmission line. It is one of a series of coupling units, end seals and other fittings for high-frequency transmission—designed and built by Lapp.

To this type of construction, Lapp brings several innovations and improvements. For example, such a line from Lapp parts is genuinely leak-proof. Every gasket is under spring loading, so there's no leakage created by vibration or thermal change.

Whether or not you're interested in gas-filled transmission lines, you ought to know about Lapp. Here is an organization of engineers and manufacturers with broad basic knowledge of ceramics and their application. With experience in hundreds upon hundreds of special-purpose electronic parts, we have been able countless times to improve performance, or reduce costs, or cut production time through

the application of our specialized skills to design and manufacture of parts involving porcelain or steatite and associated metal parts.

For quick and efficient assistance on a war production subcontract—or for the competitive advantage Lapp-designed and Lapp-built parts will give to you in the postwar battle—an inquiry to Lapp now may pay you dividends. *Lapp Insulator Co., Inc., LeRoy, N. Y.*



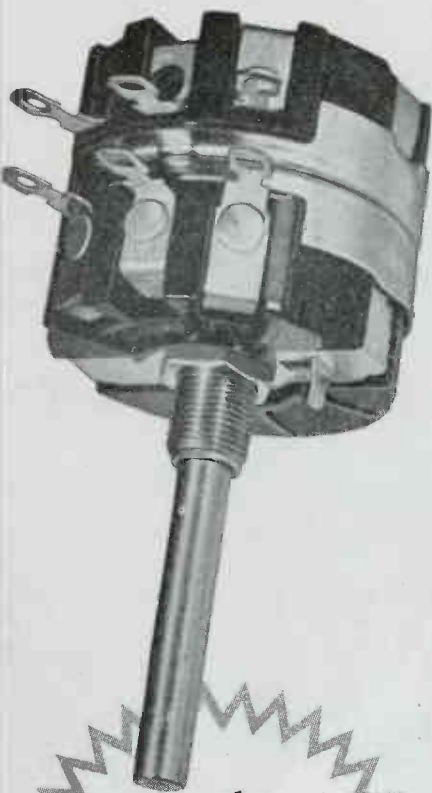

Dual Controls

★ The improved, tougher Type 58 Clarostat wire-wound control provides, among other notable advantages, a neat, more rugged, still more effective tandem dual assembly as here shown. Also with or without power switch.

The metal locating pin on front unit will not break or tear off. The bushing, keyed into the bakelite case, cannot slip or turn when locking nut is tightly drawn up. 1500 v. breakdown insulation between windings and shaft. Each center rail is in one piece with its terminal. Direct connection between winding and "L" and "R" terminals. Thus a real good dual control is made still better with these improved Type 58 units.

★ Submit your problems . . .



CLAROSTAT MFG. CO., Inc. • 285-7 N. 6th St., Brooklyn, N. Y.

production on tube sockets for radio, radar, television and industrial uses and to supervise engineering and research on specialty antennas. He was formerly chief engineer of Crowe Nameplate & Mfg. Co.

N. F. Shofstall has been appointed designing engineer of the receiver division of the General Electric Company's Electronics Dept. He will be responsible for the technical design of the products of the receiver division, with headquarters at Bridgeport, Conn. Since August, 1942, he has been acting designing engineer of the West Lynn, Mass., branch of the division.



N. F. Shofstall, made design engineer of receiver division of General Electric

E. F. Herzog has been appointed designing engineer of the transmitter division of the General Electric Co.'s Electronics Department. He will be responsible for the design of all products of the transmitter division with headquarters at Schenectady. He was formerly assistant to the chief engineer.



E. F. Herzog, who has been appointed design engineer, transmitter division of GE



CONCENTRATED Power

SM Fractional H. P. Motors for radio, communications, aircraft and many commercial applications.

Whenever you need concentrated power—maximum power per ounce of weight and per inch of space—specify SM Fractional H.P. Motors. You'll get a unit engineered and precision built to your exact specifications, a long-life motor of dependable performance. From 1/10th to 1/200th H.P. Speeds from 3,000 to 20,000 R.P.M. Voltage from 6 to 220 AC-DC. Thousands have been engineered and built for signal corps and military aircraft use. Plant facilities for large volume production. What are your requirements?

Small Motors, Inc.

Dept. 51
1308 ELSTON AVE., CHICAGO 22, ILL.

Manufacturers of special small universal, fractional H. P. motors, dynamotors, shaded pole motors, heater motors, generators.

Design • Engineering • Production

Not afraid of GHOSTS

Phoenix

REG. U. S. PAT. OFF.

TRACING CLOTH

IT's moisture-proofing that makes PHOENIX Tracing Cloth resist damp hands and arms. It will even stand up to ten minutes immersion in water. That's why it's proof against moisture ghosts — the ghosts that haunt prints made from tracing cloths that show perspiration stains.

Besides, PHOENIX is smudge ghost-proof. You can use harder pencils and still get solid, opaque lines. They'll smudge less.

And erasure ghost-proof too. Erasing leaves less scars on PHOENIX. Redrawn pencil lines are smooth. Ink won't feather.

For the full story and a sample, write on your letterhead to Keuffel & Esser Co., Hoboken, N. J.

KEUFFEL & ESSER CO.

EST. 1867

*Drafting, Reproduction, Surveying Equipment
and Materials. Slide Rules. Measuring Tapes.*



CHICAGO • NEW YORK • HOBOKEN • DETROIT
ST. LOUIS • SAN FRANCISCO • LOS ANGELES • MONTREAL

NOT NEXT WEEK
 NOT NEXT MONTH
 NOT NEXT YEAR
BUT-NOW



HARVEY

has for fast delivery
 Critical Radio and
 Electronic Components
 and Equipment

TUBES	METERS
RELAYS	TEST EQUIPMENT
CAPACITORS	TRANSFORMERS
RESISTORS	ETC., ETC.

After 18 years in the radio and electronic field, HARVEY is adept at supplying you with equipment you need—not next week, not next month, not next year—but now, just when you need it. That's the service for which we are famous. Critical items, if not on our shelves, will be traced for you, or we may be able to suggest effective substitutes. And HARVEY can help solve your priority problems, lend a hand with technical advice. Save time, save money... see HARVEY—first, last, always!

Telephone
 Orders to
LONGacre 3-1800



RADIO COMPANY
HARVEY

103 WEST 43rd ST., NEW YORK 18, N. Y.

**WEMCO Re-christens
 Two Divisions**

Changes in the names of two divisions of the Westinghouse Electric and Mfg. Co., to better describe their expanding functions now and postwar, have been made. The former Radio Division now becomes the Industrial Electronics Division, and the former Radio Receiver Division becomes the Home Radio Division. Each will continue under its present direction, C. J. Burnside, for the past three years manager of the Radio Division, heading Industrial Electronics; and Harold B. Donley, named manager of the Radio Receiver Division at its organization last year, heading the Home Radio unit. The Home Radio Division has been moved from temporary quarters in Baltimore to a permanent location in Sunbury, Pa.

**Silver Establishes
 Own Organization**

A new engineering and manufacturing company has been established in Hartford, Conn. by McMurdo Silver, known as the McMurdo Silver Company. This organization will devote its efforts primarily to the amateur parts, kit and special equipment market, and to consulting engineering for a small group of selected and non-competing clients in the radio/electronic field. A number of new and non-duplicating items of test equipment will be announced shortly.

During the past six years, Mr. Silver has devoted his energies and thirty-four years of radio engineering/manufacturing experience to the conversion of three successive manufacturers to high-quality, high-volume war radio production. He successively reorganized the Airplane and Marine Direction-Finder Corp. as its general manager from 1939 to 1941; as Executive vice-president, he directed the conversion of Fada Radio & Electric Co. to 100 per cent war output from 1941 to 1943; and in 1943-44 aided the conversion of Grenby Mfg. Co. to radar production as its vice-president in charge of radio electronics.

John F. Rider Promoted

John F. Rider, who entered active service in the U. S. Army on May 1, 1942, with the rank of Captain in the Signal Corps, has been promoted Lieutenant Colonel. From June 1, 1942, to November 17, 1943, Colonel Rider was stationed at the Southern Signal Corps School, Camp Murphy, Fla. Here he organized and became the director of the Training Literature Division. On November 6, 1942, he received his Majority.

Transferred to Fort Monmouth,



YOU

SHOULD KNOW

... the advantages of buying from a Complete Manufacturer, such as SNYDER.

Prompt Delivery

Better Price

Production Control

Maintenance of high Standards

When permissible SNYDER will be first.



ANTENNAE

by

SNYDER

MANUFACTURING CO. • PHILADELPHIA

COMPLETE MANUFACTURERS
 FROM START TO FINISH

Just Published!

PANORAMIC'S

FASCINATING, NEW BOOK FOR AMATEUR RADIO OPERATORS!



"From One Ham to Another"

Packed full of brand new information on amateur radio operation! Shows how you can solve many of your problems! Completely explains, in your own language, the PANORAMIC Technique, and what it will mean to you when you get back to your rig!

"From One Ham to Another" tells you how to get the most out of your rig. It shows you how you can have even more satisfactory QSO's with your friends all over the world. In detail it describes the problems that confront amateur radio operators... and proposes solutions. For example, after you have read "From One Ham to Another," you will know how to reduce the number of missed signals, how to determine quickly which frequencies are free, how to step up your efficiency.

Simple and pleasant to read, "From One Ham to Another" is written for the ham in terms you use. And you will be amused by the clever cartoons that illustrate it throughout. You will want to file and keep "From One Ham to Another" for the new ideas it provides. You will learn about the role that the PANADAPTOR will play in future ham operations. You'll be thrilled by the stories of war-time applications of this technique. Send for your free copy today!

"From One Ham to Another" discusses such subjects as:

- Watching for CQ's
- Answers to CQ's
- Operation of nets
- Choosing a spot in the band for your xmt
- Helping your brother ham
- Reading signal strength
- Logging the frequencies of your friends
- And many other topics of great interest

To obtain your free copy of "FROM ONE HAM TO ANOTHER," just send us a card with your name, address, and call letters if you have them. If you are now connected with radio in some way, we should like to know the name of the organization with which you are affiliated, and the type of work you do. EVEN IF YOU ARE NOT A HAM, YOU ARE WELCOME TO THIS PANORAMIC BOOK.

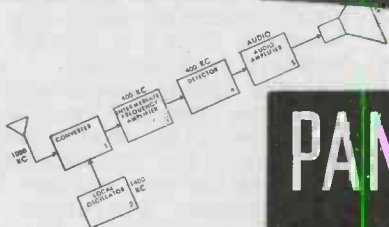

PANORAMIC



RADIO CORPORATION

242-250 WEST 55TH ST., New York 19, N.Y.

209



209SB

95c
LIST\$2.00
LIST

JOHNSON

Quality

These two Johnson sockets have identical shape and size. Only a ceramic expert can tell them apart yet the No. 209SB regularly sells for more than twice as much as the No. 209.

Our customers know that there are hidden values in the No. 209SB. It has best quality, low loss, steatite insulation and beryllium copper contacts. While the No. 209 is correct for certain applications it does not have these expensive special materials. Each socket would be a logical choice in its proper place. Although the difference is not visible to the untrained eye, it would be very obvious in a carefully gauged performance test.

Not all of our customers for the No. 209SB go into these details. They merely buy the socket for the hidden values which are built into every Johnson product, since they take Johnson's recommendations with confidence.

There are Johnson sockets for every tube type, in addition to the above old standbys.

Data for both types:

Diameter ----- 2 13/16"
 Height ----- 1 7/8"
 Type ----- UX BASE
 Mounting centers --- 2 5/16"

Ask for Catalog 9680



JOHNSON

a famous name in Radio

E. F. Johnson Co. Waseca, Minn.

HIGH SPEED ELECTRONIC PHOTO LIGHT



These two photographs were made by Arthur Palme, Pittsfield, Mass., with a home-made variation of the Speedlight originally developed by Professor Harold E. Edgerton of MIT. In both cases the damage was done with a 22 cal. rifle, the lamp bulb photo being made at 1/15,000th second and the teacup at 1/10,000th second

he organized the Radar Literature Section at the Signal Corps Publication Agency of that Fort. Here Colonel Rider was subsequently advanced to Executive Officer of the Agency and is at present Deputy Director in charge of all operations of the Agency.

Hytron Expansion

Hytron Corp., with plants employing 2,600 people in Salem, Newburyport, Beverly and Lawrence, Mass., is to double its working capital in preparation for greatly expanded postwar activities. Plans include considerably increased production of both receiving and special purpose tubes.

Secrist Joins RMA

Radio Manufacturers Association has a new director of public relations. He is James D. Secrist, for many years radio editor of the "Washington Post." He succeeds James W. Douthat, who has joined the Washington staff of the National Association of Broadcasters.

Navy Honors Leberman

Commander Palmer K. Leberman, USNR, was commended by the Secretary of the Navy March 2 for his outstanding accomplishments in providing the Navy with vast quantities of vitally needed radar, radio and sonar equipment which has contributed a significant part in carrying on the war. Under Commander Leberman's direction, electronic equipment has been delivered to U. S. ships, planes and shore stations in adequate quanti-

ties in spite of the many difficulties in production and distribution. The commendation of Secretary Forrestal was presented by Rear Admiral E. L. Cochrane, Chief of the Bureau of Ships.

Commander Leberman, a native of Sheboygan, Michigan, has been in charge of the Equipment Branch of the Bureau of Ships' Electronics Division from March, 1942, until the present time. He is a graduate of the Naval Academy in the Class of 1922 and prior to the war was President of the Radio Sales Corp., Muzak Broadcasting, and Family Circle Magazine.

It was stressed that Commander Leberman had assisted manufacturers in securing supplies of radio materials and in solving critical manpower problems. Without his efforts the Navy might have lacked badly needed equipment or might have found it necessary to accept serious delays in the delivery of critical electronic equipment to the fleet and to the naval establishment.

New Tenney Owners

Tenney Engineering, Montclair, N. J., has been reorganized and has new officers, though most of the key personnel has been retained. The new president is Monroe Seligman, formerly sales manager of the American Coils Co., Newark, N. J. Together with Cleveland A. Sewell, formerly plant superintendent of the same company, and Saul S. Schifferman, for many years an executive in the oil business, these three are the new working owners of the company. The company plans major developments in the atmospheric temperature control field.

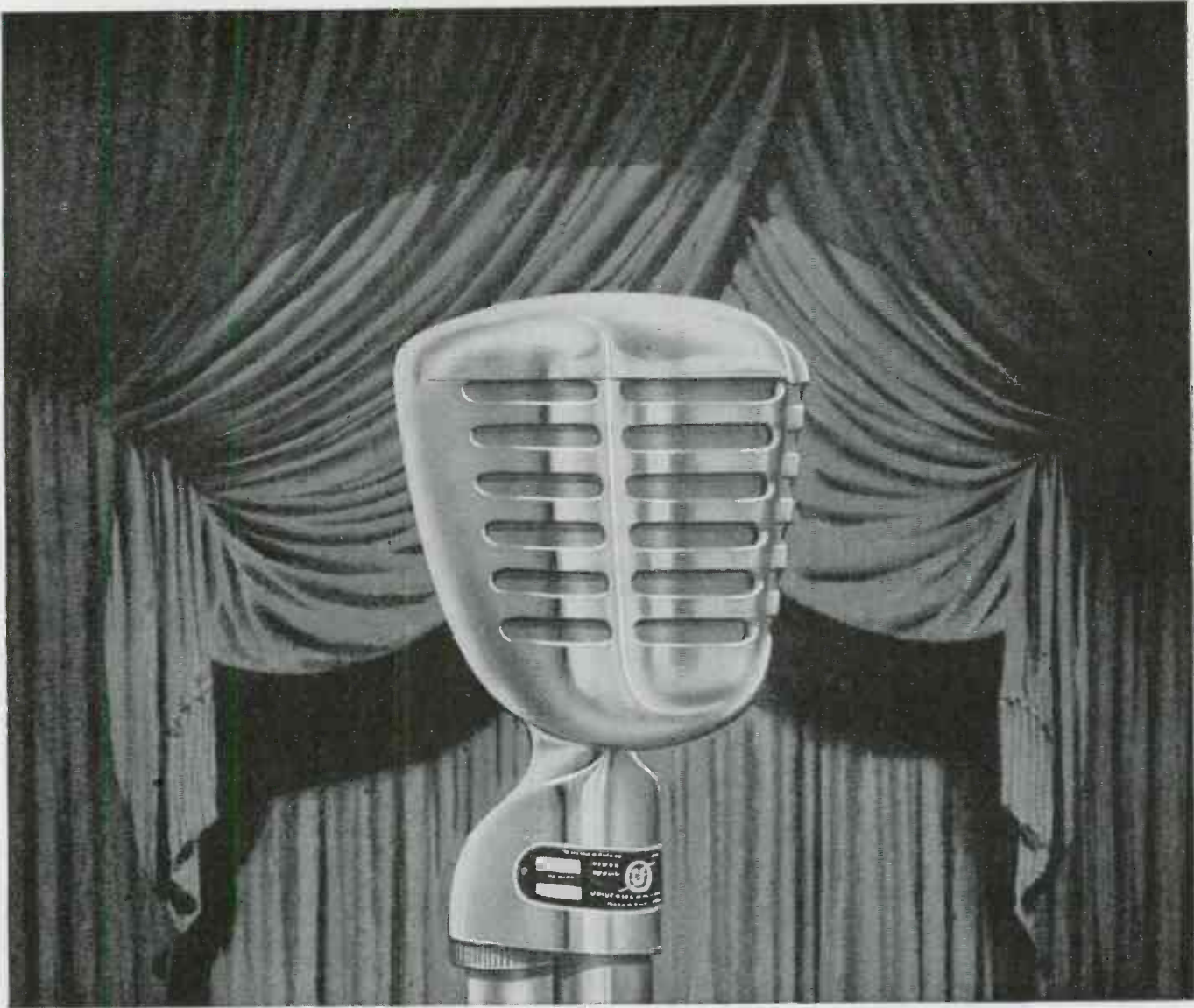

UNIVERSAL'S NEW D-20 MICROPHONE

The stage was set for something new and here it is. Universal's new D-20 Microphone . . . soon on your radio parts jobbers' shelves to fill your essential requirements . . . uses Universal's "Dynoid" construction . . . A dynamic microphone of conventional characteristics built to fill the utility requirements of war time plus advance styling of the many modern things to come. Orders placed now with your Radio Parts Jobbers will assure early delivery when priority regulations are relaxed.

◀**FREE** — *History of Communications Picture Portfolio. Contains over a dozen 11" x 14" pictures suitable for office, den or hobby room. Write factory for your Portfolio today.*

UNIVERSAL MICROPHONE COMPANY
INGLEWOOD, CALIFORNIA



Serving
Faithfully
in the
RADIO FIELD



FOR nearly two decades, ESICO has stood for superb quality and over-all economy in soldering equipment. The name ESICO on your soldering tools is definite assurance of long, uninterrupted service. Specify ESICO — the name that assures you of satisfaction.

Write Today for Complete Information On the Esico Line

ESICO SOLDERING IRONS

Designed for tough, long-lasting factory service. Widely used in industrial plants everywhere.

ESICO SPOT SOLDERING MACHINE

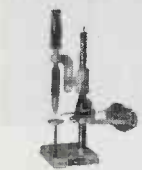

A real time-saver. Treadle-operated. Automatically advances iron and solder, leaves operator's hands free for work.

ESICO SOLDERING IRON CONTROLS



Positive TIP control prevents over-heating — tip cannot fall below soldering temperature. The only practical method of controlling heat in the tip—an exclusive ESICO feature!

ESICO SOLDER POTS



Rugged construction. Variety of sizes. Designed for continuous non-stop operation. Elements replaced easily and quickly.



★ Reg. U.S. Pat. Off.

ELECTRIC SOLDERING IRON CO. Inc.
2145 West Elm Street, Deep River, Conn.

Ellis Undertakes Electronic Research

Ray C. Ellis, former director of the WPB Radio and Radar Division from 1942 to 1944, is taking up work for the government at the Johns Hopkins Applied Physics Laboratory in Silver Springs, Md. He has been loaned for the job by General Motors Corp. to which organization he returned when he relinquished WPB duties recently. His assignment with the laboratory will be for a highly secret and specialized branch of electronic research and will require considerable time.

ATF's Induction Heating

American Type Founders, Inc., has commenced production in its Elizabeth, N. J., plant of induction heating equipment. Two models are being made, one of 15 kw capacity and the other 30 kw. Both operate on frequencies from 100,000 to 200,000 cycles.

Weiller Opens Office

Dr. Paul G. Weiller has established offices and a research laboratory at 95 Broad Street, New York 4, New York. He will undertake the design and development of electronic electromechanical or mechanical devices and instruments to predetermined specifications of salability, cost or performance. He was formerly connected with the Square D Co. and its Kollsmann Instrument Division.

Ungar Changes Name

Harry A. Ungar, Inc., Los Angeles, manufacturer of electric soldering pencils and other electrical products, changed corporate style on April 1 when the company became known as Ungar Electric Tools, Inc. Harry A. Ungar incorporated his business in 1932.

WE Licenses Knights

The James Knights Co., Sandwich, Ill., has entered into a license agreement with the Western Electric Co. and will manufacture electronic equipment under WE patents. New developments in the electronic and crystal field will be made public in the near future.

Dry Cells Increase

Preliminary reports indicate that total production of all dry cell batteries in the fourth quarter of 1944 amounted to 663,092,000 units, an increase of 22 per cent over the third quarter and a 97 per cent increase over the corresponding period in 1943. Radio batteries head the increase, being 85 per cent higher in production than last year.

DIALS PANELS and PLATES

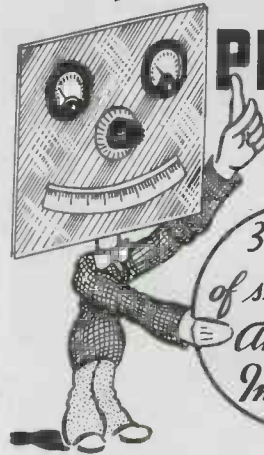

35 years of service to American Industry

DIALS · PANELS · PLATES
made to your precise engineering specifications in etched metals and finishes.

PREMIER METAL ETCHING CO.
21-03 44th AVE.
LONG ISLAND CITY, NEW YORK

El-Menco
MOLDED MICA CAPACITORS

IMMEDIATE DELIVERY

ALL SIGNAL CORP. ORDERS BEARING INSPECTION AT SOURCE; INSPECTED ON PREMISES & SHIPPED IMMEDIATELY

All R.M.A. or JAN C-5 color coded
A complete stock is ready for immediate shipment of quantities, ranging from 500 to 5,000 of each capacity in regular MICA CAPACITORS in 5%, 10% and 20% tolerance and silvered MICA CAPACITORS in 2%, 5% and 10% tolerances.

Write for price sheets and complete information

Territory open for **JOBBERS**

SEND FOR OUR SPECIAL INITIAL ORDER OFFER

ALBERT ROTHENSTEIN
National Distributor
135 LIBERTY ST. New York 6, N.Y.



RAYTHEON VOLTAGE STABILIZERS Provide Stabilized Voltage $\pm 1\frac{1}{2}\%$ WITHIN 2 CYCLES

All precision as well as other types of electrical equipment requires steady, uniform voltage for accurate operation. Raytheon Voltage Stabilizers meet this need by providing accurately controlled voltage to $\pm 1\frac{1}{2}\%$ of 1%.

Entirely automatic in operation, the Raytheon Voltage Stabilizer requires no maintenance, no adjustments. Simply incorporate it into new products or equipment already in use and it will take care of itself providing uniformly stabilized voltage.

Raytheon Voltage Stabilizers provide these advantages: Stabilize voltage at any load within their ratings . . . Hold constant varying AC input voltage to $\pm 1\frac{1}{2}$ of 1% — within 2 cycles . . . Control wide AC input variation — 95 to 130 volts. Write for Bulletin DL48-537. It gives the complete story.

**INPUT
VS.
OUTPUT
VOLTAGE**
(Type VR 2)

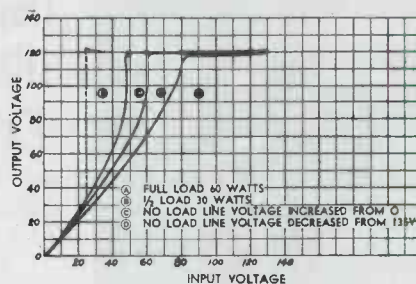

**OUTPUT
VS.
INPUT
VOLTAGE**
(Type VR 4)

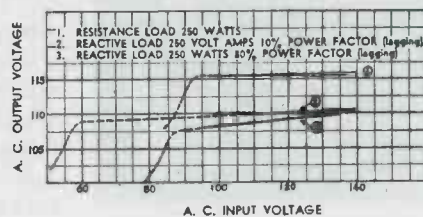

Tune in the Raytheon radio program: "MEET YOUR NAVY," every Saturday night on the Blue Network. Consult your local newspaper  for time and station



RAYTHEON
MANUFACTURING COMPANY

Electrical Equipment Division
190 WILLOW STREET, WALTHAM, MASS.

Devoted to research and manufacture of complete electronic equipment; receiving, transmitting and hearing aid tubes; transformers; and voltage stabilizers.

The coveted Army-Navy "E," for Excellence in the manufacture of war equipment and tubes, flies over all four Raytheon Plants where over 16,000 men and women are producing for VICTORY.



THERMOSTATIC METAL TYPE
DELAY RELAYS
PROVIDE DELAYS RANGING
FROM 1 TO 120 SECONDS

Other important features include:—

1. Compensated for ambient temperature changes from -40° to 110°F.
2. Contact ratings up to 115V-10a AC.
3. Hermetically sealed — not affected by altitude, moisture or other climate changes . . . Explosion-proof.
4. Octal radio base for easy replacement.
5. Compact, light, rugged, inexpensive.
6. Circuits available: SPST Normally Open; SPST Normally Closed.

WHAT'S YOUR PROBLEM? Send for "Special Problem Sheet" and Descriptive Bulletin.

AMPERITE CO. 561 BROADWAY
NEW YORK 12, N. Y.
In Canada: Atlas Radio Corp., Ltd.
560 King St. W., Toronto

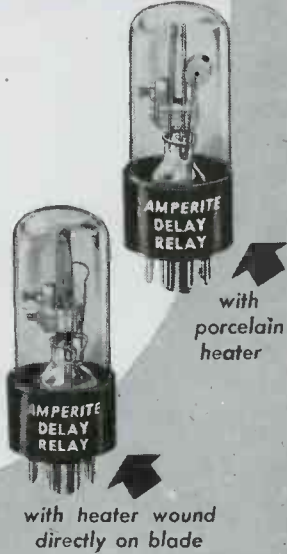

Battle Radiophotos

Radiophoto transmission between the European battle area and America over one of its 400-watt mobile transmitters has been perfected by Press Wireless, Inc., which was first to send radio news dispatches from the Normandy beachhead. The picture circuit is being operated in cooperation with the Signal Corps, Army of the United States. Tests were begun some weeks ago.

The transmitter being used is identical with the mobile transmitter which rendered service from Normandy for the press on D day plus 7. Radiotelegraph and radiotelephone are also accommodated by the unit. So far as is known, this is the first time that trans-Atlantic radiophoto service has been available from a battle area over a commercial 400-watt transmitter. The radiophotos are received through the Baldwin, Long Island, station of Press Wireless and processed at the Times Square control center which delivers them to addresses as designated by the War Department.

Powder Metallurgy

Powder metallurgy offers a means of utilizing various properties of metals to their best advantage and is a vital element in the production and control of hundreds of millions of dollars worth of products per year in tungsten products alone. Dr. Zay Jeffries, of the Plastics Division of the General Electric Co., Pittsfield, Mass., reports in the first annual medal lecture of the Powder Metallurgy Laboratory of Stevens Institute of Technology.

"A good example of the application of powder metallurgy is in the production of tungsten rod and filaments for the lamp, radio, electrical contact and other industries. In this case, the melting point of tungsten is so high that no satisfactory method has ever been found of melting and casting it into ingots. The tungsten powder is produced by reducing tungsten oxide with hydrogen. The powder is pressed into briquets and heated by the passage of electric current to a temperature near 3200° C. At this temperature the briquet consolidates into an ingot which is then worked into rod and wire.

They Save Power, Last Longer, Have Wider Voltage Range?

DRAKE Patented NEON Assemblies raise miniature jewel lighting to new heights of economy and efficiency! Power consumption is only 1/25 watt . . . length of life 3000 hours . . . voltage range 105 to 125 volts! No. 50N offers a 1/2" smooth, clear jewel. Red glass jewel also available.

The No. 51N without jewel applies where 180° visibility is desired. These popular patented Drake Assemblies are shipped complete with built-in Resistors and NE51 Neon Lamps.



Drake Patented features have been widely copied. Get the original . . . specify "DRAKE".

Socket and Jewel Light Assemblies



DRAKE MANUFACTURING CO.

1713 WEST HUBBARD ST., CHICAGO 22, U.S.A.

Vertical Radiators

An attractive illustrated brochure covering vertical radiators for broadcast stations has been issued by John E. Lingo & Son, Inc., Camden, N. J. Antenna supporting poles for other types of service are also illustrated. Handy information is given broadcasters for ground systems and FCC minimum radiator heights for all class stations throughout the standard broadcast band.



G-E MYCALEX

The development of G-E mycalex, the superior insulator possessing low dielectric power losses at high temperature, is of particular interest to the radio, electronic, industrial control and heating industries.

G-E mycalex has superior electrical characteristics and good mechanical strength. It has a low power factor, high arc resistance, chemical and dimensional stability and a low coefficient of thermal expansion. It is impervious to water, oil and gas and is unaffected by sudden temperature changes. Metallic inserts can be readily molded into the parts.

General Electric is molding mycalex for rectifier seals, brush holder studs, tube bases, switch insulation, structural parts in radio transmitters, arc chutes, relay insulators, terminal insulators and as inserts in die castings and organic plastics. For further information write Section T-50, Plastics Divisions, General Electric Company, 1 Plastics Avenue, Pittsfield, Mass.

Hear the General Electric radio programs: "The G-E All-girl Orchestra" Sunday 10 P.M. EWT, NBC. "The World Today" news, every weekday 6:45 P.M. EWT, CBS. "G-E House Party" every weekday 4:00 P.M. EWT, CBS.

GENERAL  ELECTRIC

2D-50

BUY WAR BONDS

FREE!

The famous 64-page, fact-packed book that has stimulated thousands of men!



"Forging Ahead in Business" is a practical, thoughtfully-written book with "punch" and common sense on every page. It carries a message of vital importance to every man who wants to make more money, get a better job and improve his station in life.

Partial Contents :

- Law of Success
- Forging a Career
- Organized Knowledge
- Highway of Achievement
- Making Decisions
- Failure and Success

Noted Contributors

Among the prominent men who have contributed to the Institute's training plan, which is described in "Forging Ahead in Business," are: Thomas J. Watson, President, International Business Machines Corp.; Clifton Slusser, Vice President, Goodyear Tire & Rubber Co.; Frederick W. Pickard, Vice President and Director, E. I. du Pont de Nemours & Co.

Simply return the coupon below, and your FREE copy of "Forging Ahead in Business" will be mailed to you.

MAIL COUPON TODAY

ALEXANDER HAMILTON INSTITUTE
Dept. 259 71 W. 23rd St., New York 10, N. Y.
In Canada:
54 Wellington Street, West, Toronto 1, Ont.

Please mail me, without cost, a copy of the 64-page book—"FORGING AHEAD IN BUSINESS."

Name.....
 Firm Name.....
 Business Address.....
 Position.....
 Home Address.....

American Type Consolidates Two

American Type Founders, Inc., has consolidated two of its subsidiaries, the Philharmonic Radio Corp. and the Remote Control Division. Zeus Soucek is president of the new organization. This consolidation is made in expectation of a more effective utilization of the facilities of both divisions, especially desirable at this time, in view of the general shortage of technical manpower and laboratory capacity.

The Philharmonic Co. will continue its war production of electronic devices and its postwar plans for the manufacture of radio equipment. Avery Fisher will remain as Vice President in charge of sales. The Remote Control Division will, as at present, be fully engaged in the production of precision remote controls for Navy communications equipment. Peacetime application of similar devices is planned for industrial uses as well as for home radio equipment. It will continue under the management of Mr. M. H. Hoepli.

IRE Moves to Insure Future of Radio

One of the most forward looking and far reaching programs toward insuring that radio and electronic engineering supremacy is retained by American industries has been projected by the Institute of Radio Engineers. The phenomenal growth in this field as far as quantity of apparatus is concerned is well known. But few, even among those who are associated with the industry, have any conception of the vast number of individual developments—many having tremendous post-war applications—that have been completed.

The information about any single particular subject is now closely held to a few groups. The factor which will have a great influence in getting these peacetime versions of these developments under way as readily as possible will be the dissemination of the information relative to all phases of electronic development to radio engineers. The fact that the art is highly specialized, together with the security rules that have been in force have narrowed down the activities in each individual's field to but a few specialists. But the number of these projects is large and a far reaching guided program of cooperation is needed to make such developments of greatest utility to manufacturers who may soon have a world-wide market to serve.

To remedy this situation the Institute of Radio Engineers, representing the important engineers in

The Symbol



of Time Tested QUALITY!

- Every Illinois Condenser bears the label of "TIME TESTED QUALITY" . . . manufacturing the best in capacitors is our business . . . satisfying you is our desire . . . look for the "Illinois" symbol of excellence when selecting paper and electrolytic capacitors.

ILLINOIS CONDENSER COMPANY

1160 NORTH HOWE STREET
CHICAGO 10, ILLINOIS

SKILL that saves you TIME • MONEY WORRY!

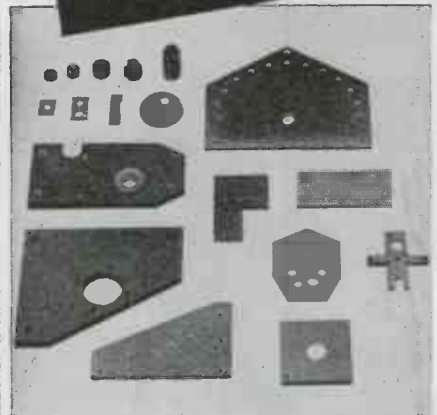

FABRICATING GLASS BONDED MICA

COLONIAL KOLONITE COMPANY 2212 W. ARMITAGE AVE., CHICAGO, ILL.

ELIMINATE

the Time Consuming

ELEMENTS

in Short Run Piercing

Don't stop long run jobs to set up for short run piercing jobs. A Wiedemann Turret Punch Press can do it with greater accuracy . . . at long run low cost.

Don't interrupt long run production to make 1 or 10 or 100 pieces of a kind, panels, chassis, outlet boxes, special gaskets, louvres, copper buss, and other pierced sheet metal parts. Use a Wiedemann!

A WIEDEMANN

Simplifies

EVERY COSTLY PIERCING OPERATION

- ★ Layout: time is completely eliminated or greatly reduced because of easily operated material positioning gauge tables . . . only one man is needed to handle the largest sheets in the press.
- ★ Conventional equipment takes 15 or 20 minutes to change punches and dies. With a Wiedemann, punches and dies operate on an easily rotated turret . . . a few seconds is all that is required to rotate turret from one punch to another.
- ★ 11 to 32 dies at your fingertips for instant piercing . . . all dies are locked into position by means of index pins after correct dies are located on turret.
- ★ No sheared punches or dies from inaccurate set-ups . . . holes are punched clean.
- ★ No waiting for die set-up man. A Wiedemann is always ready to run without tearing down any set-up.
- ★ Long run jobs can be started on your Wiedemann while production dies are being made.



Send today for Wiedemann Bulletin No. 92 to get the complete story of Short Run Piercing Economy.



**WIEDEMANN
MACHINE
COMPANY**

1833 SEDGLEY AVENUE,
PHILADELPHIA
32, PA.



With a Wiedemann Type R-7, punching is done either directly from blue prints or from charts without any layout work being necessary, merely by turning two handwheels to obtain accurate X and Y coordinate settings.

This high speed positioning of material is accomplished on a ball bearing spacing table for sheets up to 50" wide by 100" long. Any point on sheets up to 1/4" thick can be located under the punching station for piercing openings, or making louvres or knock-outs. There are no stops to set . . . from 12 to 32 stations operate on an easily rotated turret for instant piercing. Changing from one punch to another is a matter of seconds . . . practically instantaneous.



The R-4P Power Driven Turret Punch Press is furnished with 12 punches and dies up to 1 1/4" diameter, mounted in a revolving turret. An accurate, positive indexing device locks the revolving turret, when the punch and die selected for use are located centrally under the ram. This locking and unlocking is done by a small lever shown on the side of the machine; this lever being interlocked with the clutch trip mechanism to prevent operation of the machine unless the turret is properly positioned and the index lever locked in place.



WIEDEMANN TURRET PUNCH PRESSES & GAUGE TABLES

BLUE PRINT to SERVICE

ON URGENTLY REQUIRED
RADIO PARTS · TUBES
ELECTRONIC EQUIPMENT

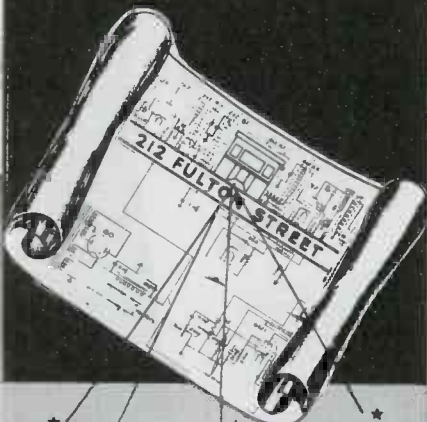

★ PHONE TELETYPE TRAINED
BRClay Direct fast wire SERVICE to our PERSONNEL
1840 premises. Code-RGY-New York

★ OVER 10,000 ITEMS IN STOCK
FOR IMMEDIATE DELIVERY!

★
Everything in

TUBES · METERS · CONDENSERS
RESISTORS · TRANSFORMERS
TEST INSTRUMENTS · WIRE
AMPLIFIERS · SOUND SYSTEMS,
PLUGS · JACKS · SWITCHES
METAL CHASSIS · RACK PANELS, etc.

**PURCHASING AGENTS!
ENGINEERS!**

Send for this
FREE 800 PAGE CATALOG!

Write today on your company letterhead for
this massive 800 page Buying
Guide containing everything in
radio-electronics. Complete
listings of all standard na-
tionally known products
in one handy, bound vol-
ume! Sent free on request
by addressing Box AE.



This Book
Can Help Answer
Your Procurement
Problems!

SUPPLIERS TO

Industrial Manufacturers · Research
Laboratories · Schools · Colleges
Government Agencies · Railroads
Public Utilities · Broadcast Stations
Hospitals · Shipyards · Police Depts.

America's
MOST COMPLETE
Source of Supply

**SUN RADIO
& ELECTRONICS CO.**

212 Fulton Street, New York 7, N. Y.

this field, is fostering an elaborate and forward looking program for aiding the postwar activities in these fields. The promotion of engineering standards will provide all engineers with a common set of terms and test methods. The work of arranging the preparation of and publishing details of hundreds of application principles (many of them now classified in the realm of military secrets), is another phase of this work. Giving greater service to engineers in more remote sections through enlarged and more numerous branch sections, is a third. Providing information service to those engineers of the required quality, in such a highly technical and widely diversified field requires not only additions to the staff of men having the specific qualities in training and experience to handle the jobs, but also adequate equipment facilities so that their help can be most effectively utilized.

Postwar plans

All in all the plans include the following activities: the post-war publication of a large amount of material now held secret, annual publication of a Year Book, better correspondence service with the sections, program aid to sections, section aid by traveling lecture-ships, formation and professional direction of semi-autonomous specialist groups in the larger sections, integration of a conference program reaching all parts of the country, proper organization of college activities and other educational work, full-time supervision of standardization activity, creation and housing of a technical library, establishment of employment and placement bureau, activity in legislative matters, additional liaison work with other societies, Government and engineering bodies.

The nucleus of this program will be the concentration of all activities undertaken by the enlarged Institute in a new headquarters building, which will become a center for the promotion of all activities relating to that profession. In view of the most remarkable strides that have been made by the engineers of this organization in giving to this war the most scientific devices ever developed by any country, this building will have international importance, because the peacetime products of the same group will have world-wide value.

Already the impact of this project has been shown by the nationwide response of both the members and the industrial organizations who foresee the significance of the work, in providing the financial backing to insure adequate handling of the needed activities. Response is also remarkable as to the num-

Wanted ENGINEERS

Radio

*Electrical

Electronic

*Mechanical

*Factory Planning

Materials Handling

Manufacturing Planning

Work in connection with the manufacture of a wide variety of new and advanced types of communications equipment and special electronic products.

Apply (or write), giving
full qualifications, to:

R.L.D., EMPLOYMENT DEPT.

Western Electric Co.

100 CENTRAL AV., KEARNY, N. J.

*Also: C.A.L.

Locust St., Haverhill, Mass.

Applicants must comply with WMC regulations

PRODUCT ENGINEERS

A progressive manufacturer of electrical products needs five product engineers to do trouble shooting, shrinkage analysis, materials engineering, etc.

Applicants for these positions should have a degree in either electrical engineering or physics and at least five years' engineering experience of an important nature, requiring the use of independent judgment and thoroughgoing analysis of electrical engineering problems.

Early interviews will be arranged for qualified applicants furnishing full details regarding age, education, experience and salary requirements.

BOX 3529

ELECTRONIC INDUSTRIES

480 Lexington Avenue
New York 17, N. Y.

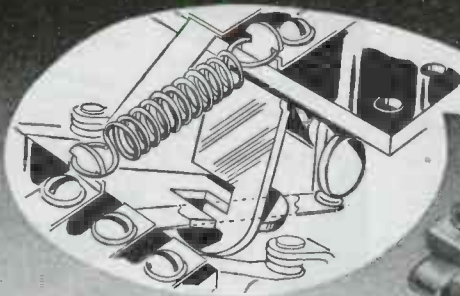

Exclusive Struthers-Dunn "Memory" latch interlock permits wide variety of applications.

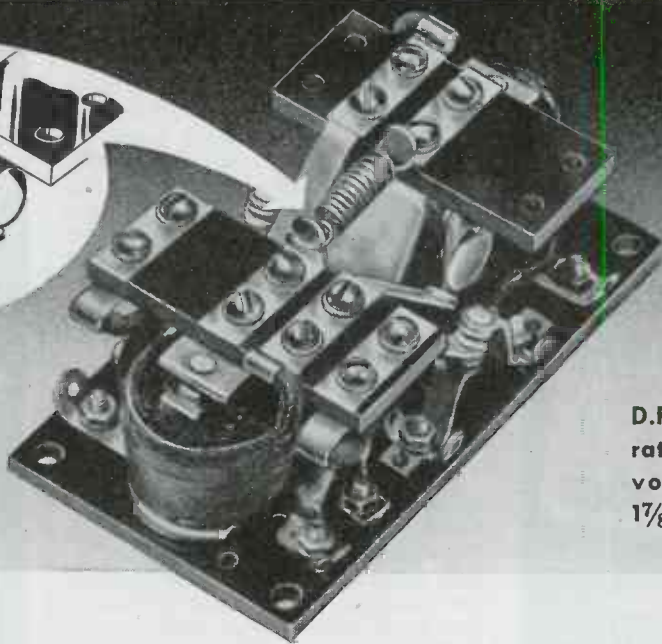

**TYPE
50XBX103**

D.P. D.T. main contacts, rated 6 amps. at 24 volts DC. $3\frac{7}{16}$ " long; $1\frac{7}{8}$ " high; $1\frac{5}{8}$ " wide.



A New Struthers-Dunn "MEMORY" RELAY SERIES

Simplified Interlock—Symmetrical Design

Sturdily constructed to aviation specifications, and of immensely simplified design, Series 50XBX 2-coil Relays are an important addition to the well-known line of Struthers-Dunn "Memory" types. A new style positive interlock between the two symmetrical operating elements represents latch-in relay construction in its simplest, most dependable form. This latch requires no extraneous parts other than integral extensions of the sturdy coil "armatures" themselves. It operates positively from a momentary impulse and a minimum of power. Application of power to one coil latches the contacts into one position. Power then applied to the other coil throws the contacts into a latched-in second position.

A third "unlatched" position, valuable for certain applications, can be obtained by energizing both coils simultaneously.

The 50XBX design makes it easy to obtain make-before-break, or break-before-make contact combinations. Contacts do not interrupt the coil circuit until the "throw" is entirely completed and contacts are locked in the new position.

Struthers-Dunn Memory Relays of this general type are produced in ratings from 6 to 200 amperes or more, and with practically any desired contact arrangement. Standard types provide for two auxiliary contacts, one in each coil circuit. The use of auxiliary contacts makes it possible to obtain operation over an extremely wide range of voltages, a-c or d-c.

STRUTHERS-DUNN, INC., 1321 Arch Street, Philadelphia 7, Pa.

STRUTHERS-DUNN

5,288 RELAY TYPES

DISTRICT ENGINEERING OFFICES: ATLANTA • BALTIMORE • BOSTON • BUFFALO • CHICAGO • CINCINNATI • CLEVELAND • DALLAS • DENVER • DETROIT • HARTFORD
INDIANAPOLIS • LOS ANGELES • MINNEAPOLIS • MONTREAL • NEW YORK • PITTSBURGH • ST. LOUIS • SAN FRANCISCO • SEATTLE • SYRACUSE • TORONTO • WASHINGTON

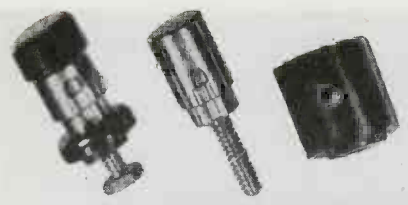

**THERE IS NO
SUBSTITUTE
FOR EBY
SPRING BINDING POSTS**



From the product designer through to final assembly and use in the field, the Eby Spring Binding Post line offers top service based on dependability.

The spring binding post offers unique advantages that can't be duplicated:

1. No screw cap to tighten or come loose with vibration.
2. Constant, even pressure on the wire at all times in all positions.
3. Easy one-hand feeding of wire into the post.
4. Corrosion - resistant, long-life springs.
5. Complete range of sizes, stem lengths, and accessories for every application.

Replace with Eby Spring Binding Posts — Write today.

**HUGH H.
E B Y**
INCORPORATED
18 W. CHELTENAVE.
PHILADELPHIA, PA.

ber of new applications for membership from the engineers and research workers in this profession who see in this program the most practical way of getting "educated" as to all of the advances made by others during the past five years.

The enthusiasm evident from the response to the call for help on this building project has been such that assurance can be given that it will go through, and work is progressing to the next steps in the plan, that of the procurements and outfitting a suitable structure.

Hundred Million Postwar Radios

American families will buy 100,000,000 radios within the first five or six years after total victory, with two-thirds of the current population ordering the first new sets on the market—preferably combination radio-phonograph models. More people say they will pay an additional \$75 for television than will spend \$10 extra for F.M. but if FM doesn't dig a hole in their pockets any deeper than \$5 they say they want it almost to a man; demand as many gadgets as they can get, insist on short wave although they seldom use it on their present sets.

These were a few of the features of postwar buying forecast through a nationwide survey of home radio owners, revealed by Frank Mansfield, director of sales research, Sylvania Electric Products Inc. As soon as radios become available, over twenty million families will buy new ones. Over 46 per cent say they want radio-phono models, the majority preferring console styles. Analyzing these figures, Mr. Mansfield declared that they show a trend toward one basic model for each home and additional small sets in other rooms—kitchen, bedroom, playroom and the like. First ten of the brands now in use rate in the following order are, according to survey figures: Philco, RCA, Zenith, Emerson, Silvertone, General Electric, Crosley, Majestic, Air Line, Stewart Warner.

The 31,000,000 radio homes in the country now have an average of 1.54 sets per home and, according to Mr. Mansfield, not only is there a steady increase in the number of people owning a radio but an equal growth in the number of families owning two or more sets is indicated. While the average set is turned over every seven years, half the radios now in operation are between four and eleven years old and their owners have little to say against them. Only five per cent expressed any real dissatisfaction.

Explaining the forecast of 100,000,000 radio sets in the homes of 194X, he said, "Thirty-six million families now populate the United States and our survey shows that over 83 per cent have home radios,



FAST WORK ON YOUR WAR ORDERS

● If your needs are urgent, take advantage of our extremely large and complete stock of radio-electronic supplies and parts. Most orders can be filled immediately from stock, and shipped the same day received.

And to help you order just what you need, we have the big Dalis catalog which is yours for the asking. Write on your business letterhead for your copy.

● Try Dalis—just wire, 'phone or write . . .

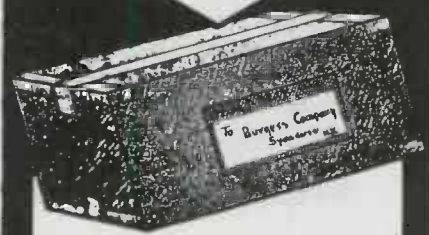

H. L. DALIS, INC.
Wholesale Distributors
RADIO-ELECTRONIC SUPPLIES & PARTS
17 Union Square
NEW YORK 3, N. Y.
Phones: ALgonquin 4-8112-3-4-5-6-7

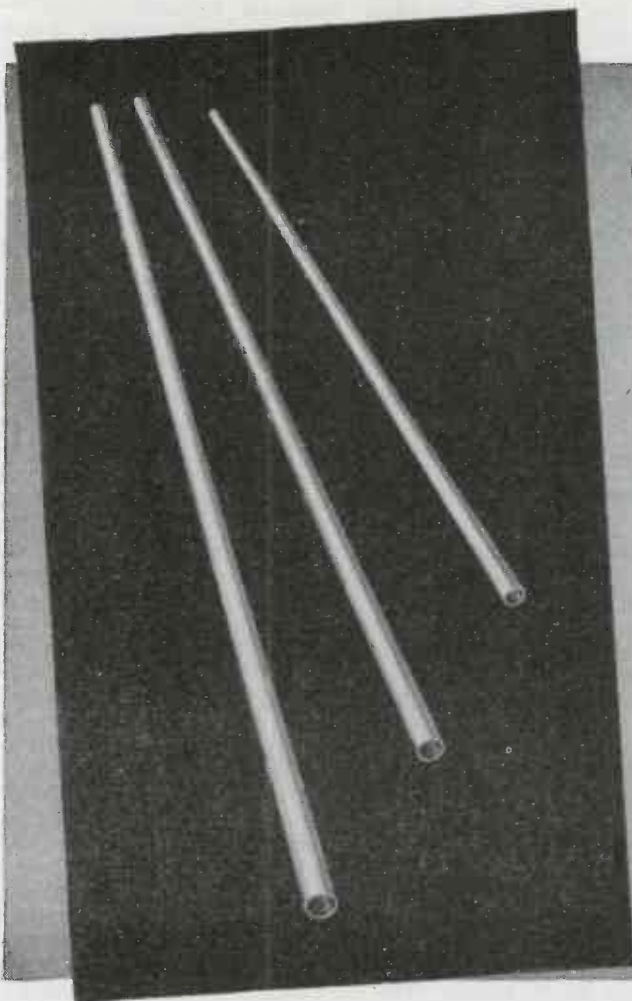

WILCO ANNOUNCES

Larger Plant

New Equipment

Increased Facilities

for producing

TUBING

The demand for Wilco tubing, wire and other products used in various electronic applications for the Army and Navy has caused the H. A. Wilson Company to increase its manufacturing facilities and develop new products and techniques. Both present and future customers will find these new Wilco developments of great advantage.

The H. A. Wilson Company manufactures and is interested in receiving inquiries regarding the following products—

WILCO RADIO TUBING

Silver Tubing (Fine, Coin, Sterling)
Gold Tubing (any karat)
Gold on silver (on one or both sides)
Gold on bronze (on one or both sides)
Silver on copper (on one or both sides)
Tubing made to order from special materials or any combination of materials.

WILCO RADIO WIRE

Silver (Fine, Coin, Sterling)
Silver-jacketed Invar
Silver-jacketed Brass and Bronze
Silver-jacketed Copper
Gold Wire
Gold on silver
Gold-jacketed Bronze and Brass
Any other type of jacketed wire desired

Let us analyze your problems. Write

THE H. A. WILSON COMPANY

105 Chestnut Street, Newark 5, N. J.

Branches: Detroit • Chicago

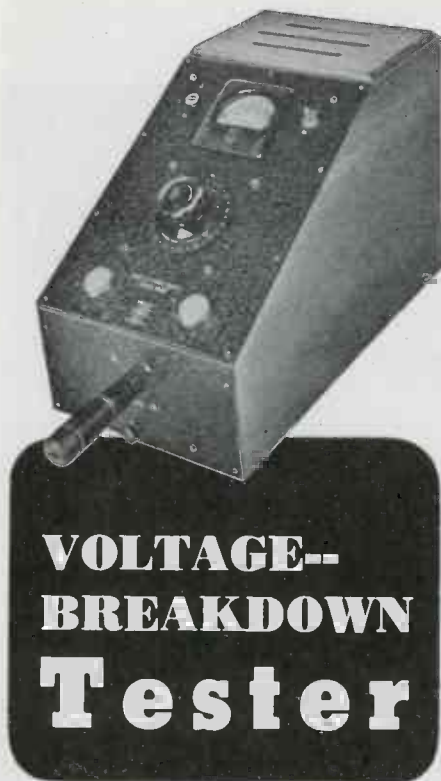

● A simple, positive, safe and quick means of testing D.C. voltage-breakdown on materials or components. Used in the laboratory or out in the plant. Can be operated by usual factory personnel.

- Plugs into standard A.C. outlet. Rectifier provides 1 to 4000 v. (Type P-1 here shown) or 1 to 10,000 v. (P-3 large cabinet type), D.C., continuously variable.
- Red panel light indicates "On" or "live". Variac knob is rotated until meter reads desired test voltage.
- Second panel light indicates when breakdown occurs, and meter gives the breakdown voltage.
- Current-limiting resistors keep current to approximately 5 milliamperes on P-1, or 40 milliamperes on P-3, over full range, as safety measure.
A standard test equipment now available for prompt delivery.

Typical of the large and growing line of "Industrial Instruments"—instrumentation for everyday work about laboratory or production line—practical, dependable, moderate in cost.

● Write for Literature

	Industrial
	PLANT and OFFICES:
	17 POLLOCK AVENUE
	JERSEY CITY 5, N. J.
Instruments:	

totalling approximately fifty million sets. Once the war is over, the number of families will increase at the rate of a million a year for the following five or six years. Returning veterans will marry and set up new homes while others, already married but living with their parents, will set up housekeeping for themselves. All of them will want radios. Add to this the steady increase in home radio ownership apparent before the war, and the average turnover rate of seven years. Simple arithmetic gives the seemingly startling total of 100,000,000 radios including automobile sets."

Army Has Troubles With French Phones

Even though no major fighting occurred in Paris when the American and French forces took over, the Nazis managed to throw all metropolitan communications in the French capital into a state of chaos just before they pulled out. While the exit of the Germans fortunately was so hasty that they could not destroy the telephone plant and it was only moderately damaged, many problems presented themselves to the U. S. Army Signal Corps officers and men in taking over the facilities.

The switchboard and automatic equipment were of German manufacture and were different from anything known in the United States or used by the U. S. Army. Most of the designation strips, multiple cards and other aids to operation had been destroyed and the few which had been left had been scattered all over the plant. Although a few circuit diagrams and circuit descriptions were found, these were in German and specially trained interpreters had to be secured to translate the very technical German markings.

There were many hard tasks—it was necessary to buzz out leads, trace cables, make up new multiple charts, learn German circuits, terms and methods and experiment in a hundred ways. The plant was

equipped to handle 1,300 extension lines with an associated twelve-position switchboard relay. From the central plant, established for the Allied military telephone system center, underground cables radiated to about 20 other buildings and the Army system had to be connected with the regular French PTT.

In the early weeks the rehabilitation job was handled by a small unit, consisting of two officers, a few non-coms and 22 enlisted men.

Two-Way Life Boat Equipment

Two-way radio sets, as part of standard lifeboat equipment, are being perfected by the Federal Telephone and Radio Corp. affiliate of the International Telephone and Telegraph Corporation. Previous protection of this nature contained only one-way transmission, but the receiver built into the new type apparatus will supply an added lift to the morale of survivors by permitting them to remain in constant touch with approaching rescue craft. In the event that there is a radio operator in the boat, medical advice also can be supplied if necessary.

The receiver will pick up the usual signals on both long and short-wave, but is not adapted for vocal use. The present equipment sends signals only on the international distress frequency of 500 kc. The new transmitter will send on that frequency and also is capable of sending on short-wave. The latter will be especially valuable in determining the exact location of the craft by means of direction finder equipment.

The new apparatus will occupy no more space than is taken up by the single frequency transmitter, now in use in lifeboats. Like the present equipment, the new set will be contained in a watertight case that will float unharmed if it falls out of a lifeboat. Power for the transmitter and receiver will be furnished by a manually-cranked generator.

PROJECT ENGINEER ELECTRONICS DESIGN

Capable, versatile, progressive young Engineer, to undertake overall direction of development projects in growing electronics division of well-established engineering and research firm. Must be sufficiently well-grounded both in theory and practice to handle wide and interesting variety of projects largely related to industrial control, instrumentation and electro-mechanical devices. Servo-mechanism experience desirable. . . . Engineering or research graduate, with 5 years intensive industrial development experience desired. Must be analytical and capable of unguided direction of development groups.

WIDE OPPORTUNITY FOR RIGHT MAN

Excellent Salary

Location New York City

Write qualifications

Box 969, Equity, 113 West 42 St., N. Y. 18



FOR ADVERTISING AND BOOK RATES, CONSULT YOUR AGENCY OR WRITE

MacRae's Blue Book

A DIRECTORY OF AMERICAN INDUSTRY

19 E. HURON STREET

CHICAGO 11, ILL.

LECTROHM } WIRE WOUND ADJUSTABLE } VITREOUS ENAMELLED RESISTORS

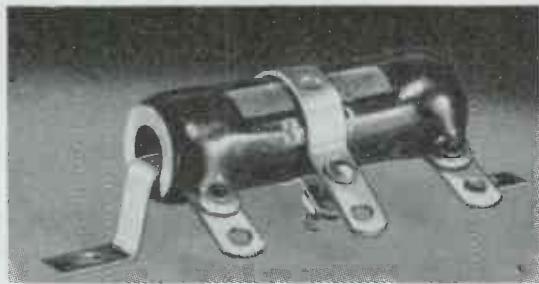

Experience Built
under personalized supervision

Lectrohm adjustable Resistors are a precision product. Resistance wire is silver soldered to the solder lugs by special process, assuring perfect electrical bond always. A thro vitreous enamel coating completely embeds the accurately spaced winding, terminals and silver soldered connections—producing a solid, integral unit. These Resistors are used as voltage dividers, or potentiometers and can be equipped with several adjustable bands. Capacities 10 watt to 200 watt. Request complete information.



5139 West 25th Street, Cicero 50, Illinois
Division of National Lock Washer Co., Newark, N. J.

LET OUR TEST EQUIPMENT ENGINEERS HELP YOU



ELECTRONIC COMPARATOR

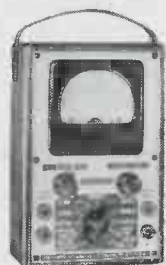

MULTITESTER

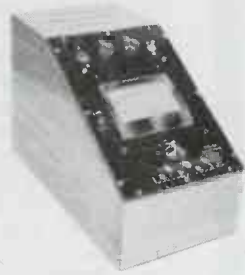

MEG OHM METER

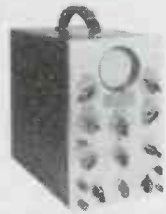

OSCILLOGRAPH

THE correct Electronic equipment can solve your research, production and inspection problems. Let our highly trained experts help you select the instruments best suited to your needs. Ask them for advice and for help with W.P.B. forms and priority information. You'll get speedy delivery from our Industrial Emergency Service Department since large stocks are maintained of such widely known lines as RCA, Dumont, Triplet, G.E., Industrial, Jackson and Hickok.

OTHER DEPARTMENTS TO SERVE YOU

- Electrical Maintenance
- Plant Sound Systems
- Shop Tools and Equipment
- Industrial Lighting
- Electronic Production Equipment

Please indicate in the coupon below, the Industrial brochures you want. And send for the free copy of our Reference Book and Buyers Guide. It describes many new electronic products for Industry.

FILL IN AND MAIL TO YOUR NEAREST ELECTRONIC MILL SUPPLY HOUSE!

WALKER-JIMIESON, INC.

311 S. Western Avenue, CANal 2525, CHICAGO 12

RADIO SPECIALTIES CO.

20th & Figueroa, Phone Prospect 7271, LOS ANGELES 7

Send Free Reference Book & Buyers Guide.
Please send the following Brochures for Industry:

- Test and Inspection Equipment
- Electrical Maintenance Equipment
- Plant Sound Equipment
- Shop Tools and Equipment
- Industrial Lighting Equipment
- Electronic Production Equipment



NAME _____ TITLE _____
 COMPANY _____
 STREET _____
 CITY _____ ZONE _____ STATE _____

**DON'T LET
YOUR ELECTRONIC
NEEDS BE
A PUZZLE . . .**

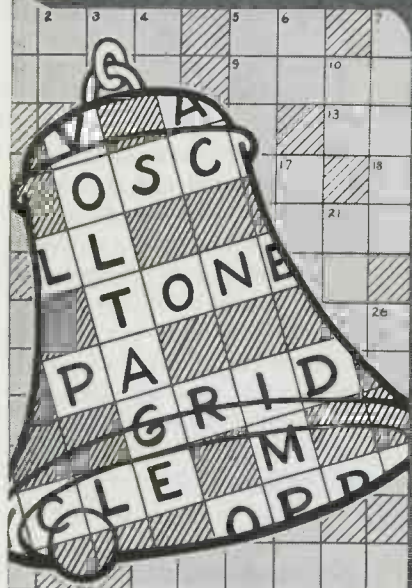

**. . . BELL
MAY HAVE
THE ANSWER!**

Whether it be electronic controls or assemblies—either as part of your product, or as part of your production equipment — BELL may have the answer! Wide experience in designing and building electronic equipment—from early developments right through to the latest war-vital types—qualifies BELL to serve you. Write, there is no obligation.

Among our present products are

- Electronic Sound Devices • Inter-communicating Systems • Industrial Voice-Paging and Broadcasting Equipment • Permanent and Portable Amplifying Systems • Recording and Disc-Playing Units • Electronic Controls • Operating Sequence Recorders • Other Special Electronic Devices.



BELL SOUND SYSTEMS, INC.
1195 Essex Ave. Columbus 3, Ohio
Export Off. 4900 Euclid Ave., Cleveland 3, Ohio

LETTERS

Snow Static; Sand Static

Editor, "Electronic Industries":—

Several years ago, while recovering from an operation, I constructed a small shortwave transmitter which I operated in my bedroom. Snowfall in this part of Texas is rare, but one morning in January, I was awakened by a buzzing noise in the direction of my transmitter. I saw a stream of blue flame jumping the gap between the rotor and stator plates of the small condenser employed in the tank circuit of the transmitter. Upon looking out of my window, I discovered that a heavy snow was falling. This condition in the tank-condenser prevailed for the duration of the snowfall.

I later had occasion to talk with a number of radio amateurs who formerly operated in the western part of this state. On certain frequencies, they report a condition which they term "sand static." They stated that each time a heavy sand storm occurred they had static which prevented radio reception.

These charged snow or sand particles may or may not cause the interference by contact with the antenna, but also, I think, might well produce "static" by contact with one another, or through the medium of radiation by discharge of their stored energy upon making contact with the earth.—M. M. Walker, Wharton, Texas.

Multi-Path Problems

Editor, "Electronic Industries":

The idea expressed in "Easing Multipath Problems" represents one approach to the solution of multipath and shadow effects, and while it appears to be rather a bold one, I believe that it may well be placed before the industry to obtain reactions as to its practicability. While I have not been able to give the proposal sufficient consideration to feel qualified to pass upon its merits, the following thoughts have occurred to me and are offered with the foregoing limitation as to their possible value.

The coverage will increase with height as you have indicated, other factors being equal. As the transmitted frequencies are increased to the point where shadow effects are evident, the height of the antenna will help to decrease the shadows and multipath effects. The proposed location of the tower should tend to eliminate shadows in surrounding rural and urban areas but might not result in better service to lower Manhattan than placement of the antennas on top of the

ELECTRICAL ENGINEERS

Look ahead

**to 1950 and 1960 with us!
WHY? —**

Because we:

- 1—Are progressive.
- 2—Are expanding.
- 3—Have a huge Post-War program.
- 4—Have a back log of unfilled civilian orders.
- 5—Offer unexcelled advancement possibilities.
- 6—Are now engaged in war work in radar, sound amplification, small motors, motion picture projectors and many electrical and mechanical devices, most of which will be retained for civilian production.

**RIGHT NOW WE NEED —
Two Engineers**

FIRST:

An electrical engineer on single phase, fractional horse power motors who can design motors to customers' specifications. He must be able to test and set into production his design.

SECOND:

Engineer for development of motion picture sound amplifiers. This position requires a man with an excellent theoretical background and at last five years' practical experience.

Location is in the largest industrial center of the middle west with good schools and living conditions. Our employees know of this ad. Must be able to secure War Manpower Commission inter-area clearance and comply with all regulations. These are expansion jobs—not replacements.

**BOX 4597, ELECTRONIC INDUSTRIES
480 Lexington Ave., New York 17, N. Y.**

- Impervious to moisture, grease, oils, acids, alkalis.
- Printing guaranteed not to wash or rub off.
- Non-inflammable, non-corrosive plastic.
- Printed and laminated vinylite and cellulose acetate.

SAMPLES AND ESTIMATES GLADLY SUPPLIED ON REQUEST
WRITE DEPARTMENT E, 1.

THE HOPP PRESS, INC.
PRINTING — FABRICATING — FORMING

460 W. 34th STREET, N. Y. C.
ESTABLISHED 1893

Now ACCURACY IN RUGGED MOVING IRON VANE AND DYNAMOMETER INSTRUMENTS

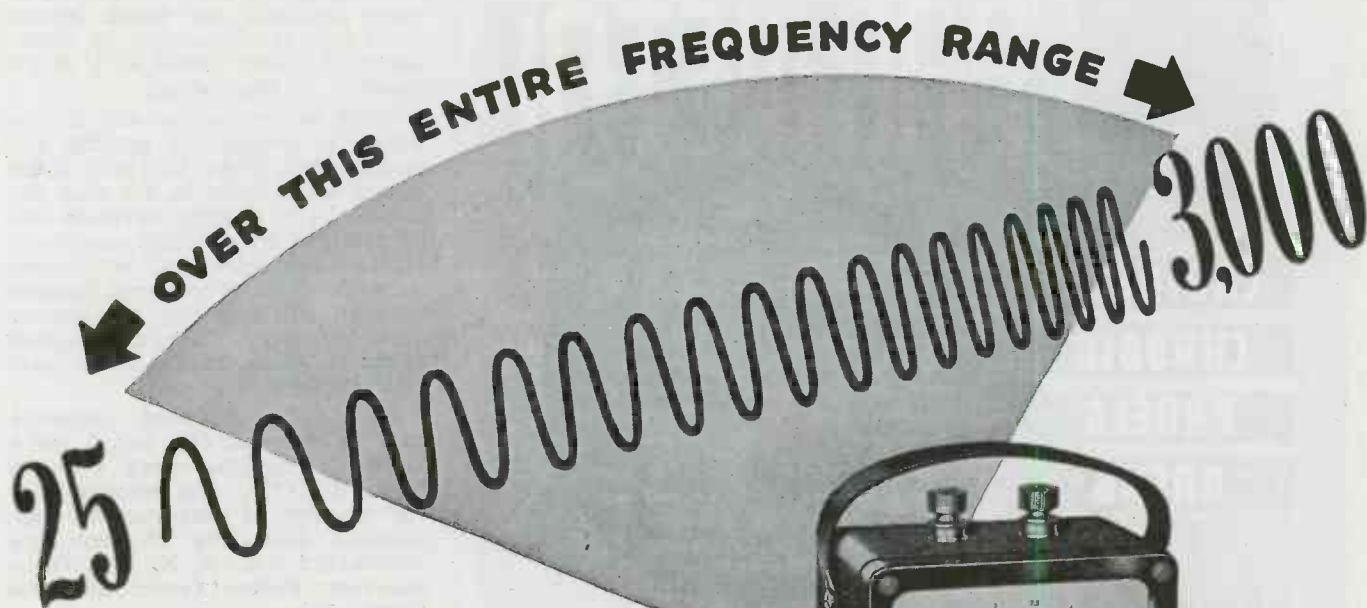

WESTON FREQUENCY COMPENSATED INSTRUMENTS

This is another WESTON contribution born of war's needs, wherein the growing use of equipment operating in the higher power frequency range necessitated instruments of *broad flexibility* plus the *rugged dependability* which moving iron vane and dynamometer instruments provide.

And throughout industry today, the growing use of power frequencies above 60 cycles, with the smaller transformers, higher speed motors, simpler rectifier filter systems, makes

the use of these instruments essential for their dependable indications and for their economy as well.

Weston is furnishing these instruments as ammeters, voltmeters, and wattmeters, in both portable and switchboard types; flat compensated up to 1000 . . . 2000 . . . 3000 cycles for general laboratory use, as well as for specific application to electronic and power apparatus. Weston Electrical Instrument Corporation, 666 Frelinghuysen Avenue, Newark 5, N. J.

Weston Instruments

ALBANY • ATLANTA • BOSTON • BUFFALO • CHICAGO • CINCINNATI • CLEVELAND • DALLAS • DENVER • DETROIT • JACKSONVILLE • KNOXVILLE • LOS ANGELES • MERIDAN
MINNEAPOLIS • NEWARK • NEW ORLEANS • NEW YORK • PHILADELPHIA • PHOENIX • PITTSBURGH • ROCHESTER • SAN FRANCISCO • SEATTLE • ST. LOUIS • SYRACUSE
In Canada, Northern Electric Co., Ltd., Powerlite Devices, Ltd.



Craftsmanship by

PAR-METAL

CABINETS

CHASSIS

PANELS

RACKS

When skill of a high degree becomes habitual, and shows up in the smallest detail — that's *Craftsmanship!*

Having specialized for many years, Par-Metal has this *habit of Craftsmanship* — expressed throughout the entire line, which ranges from small chassis to housings for huge transmitters.

To get a picture of what Par-Metal can do now (and the post-war possibilities) write for a copy of Catalogue No. 41-A.

PAR-METAL PRODUCTS CORPORATION

32-62—49th STREET . . . LONG ISLAND CITY, N. Y.

Export Dept.

100 Varick St. N. Y. C.

*dependable
durable
efficient*

American Beauty

ELECTRIC SOLDERING IRONS

Preferred by those who measure the value of a tool by the service it renders. Soldering irons are made in 5 sizes and for low as well as standard voltage.



TEMPERATURE REGULATING STAND

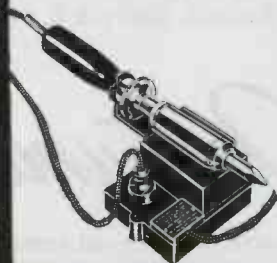

A thermostatically controlled stand for regulating the temperature of an electric soldering iron when at rest. The thermostat is adjustable for various heats.

Write for Catalog Sheets.

**AMERICAN ELECTRICAL HEATER COMPANY
DETROIT, MICHIGAN**

8-42 101AE

Empire State or similar tall building in Manhattan.

The angle of arrival of the waves does not appear to be materially steeper and the free space field strengths, for a given radiated power, would be less by reason of the greater distance to the antenna. Reflections from the Palisades would be avoided, and this might result in material benefit to some locations for which ghosts could not be eliminated by directional antennas aimed at a single location in Manhattan.

While better service will be obtained in general by placing antennas high above the area to be served, it appears to me that the answer as to whether coverage will be obtained by specially constructed antenna sites will be largely determined by an economic balance between site cost and transmitter cost, together with considerations of the resulting hazard to air traffic in certain instances.

While the proposed structure may be economically sound for a large metropolitan area such as New York City, it is believed that the erection of exceptionally high antenna structures will not find widespread use.—**E. K. Jett**, Commissioner, Federal Communications Commission.

Engineers' Salaries

Editor, "Electronic Industries":—What will be the reaction by our young graduate engineers, trained by the armed forces in electronics, spending two or more years practicing their profession in the armed forces, to see that already propaganda is starting on "high titles" and "low salaries." What is the incentive for them to be "Assistant Engineer" at the tremendous salary of \$300 per month?

"Of course, you cannot start in as Assistant Engineer," the applicant is told, "We must first give you our own special training." So the recruit is offered the title of "Apprentice Engineer."

There are just so many jobs regardless of their pay; and these young electronic engineers need not follow in the footsteps of the older profession but should receive a salary above an average living standard pay.—**Steel Engineer.**

Navigation Beacons

Editor, "Electronic Industries"—In the field of navigation, there are numerous devices employed to indicate the directional position of a craft with respect to some arbitrary point. These evolve from four fundamental methods, namely radio, magnetic, gyroscopic, and celestial. Variations and combinations of these methods perform reasonably well but each has its

THE GRAYHILL ROTO-SWITCH HAS BEEN DESIGNED TO BE USED FOR PRACTICALLY ALL CONCEIVABLE APPLICATIONS IN THE WAY OF SPECIAL CIRCUIT COMBINATIONS. UNLIMITED MULTIPLICITY OF CIRCUITS IS PERMITTED BY THE BUILD-UP FEATURE. AMPLE VOLTAGE CLEARANCE FOR HIGH VOLTAGE CAN BE SUPPLIED.

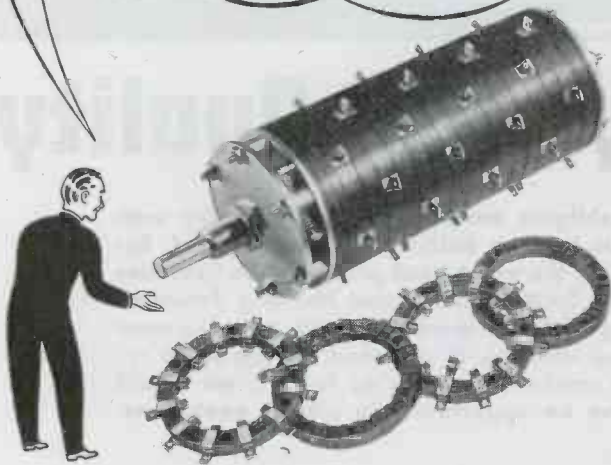

Grayhill

9 North Pulaski Road, Chicago 24, Illinois

25 YEARS

Specialization in

RELAYS



New Feature . . . eliminates "bounce" and "chatter"



Microphone Hummer

Twenty-five years' experience in solving all types of Relay Problems . . . Complete facilities for Designing, Engineering, Manufacturing . . . Specialists in producing Relays of exceptional power and sensitivity for Aircraft, Intercommunications-Systems, Electronic Devices. Exclusive Kurman features provide greater dependability, longer life, more precise performance . . .

Send data for quotations. Write for new descriptive Bulletins.

KURMAN ELECTRIC CO.

35-18 37th STREET • LONG ISLAND CITY 1, N. Y.



1,001 USES

Condensed Power for Years of Service

VERSATILITY and dependability were paramount when Alliance designed these efficient motors—*Multum in Parvo!* . . . They are ideal for operating fans, movie projectors, light home appliances, toys, switches, motion displays, control systems and many other applications . . . providing economical condensed power for years of service.

Alliance Precision

Our long established standards of precision manufacturing from highest grade materials are strictly adhered to in these models to insure long life without breakdowns.

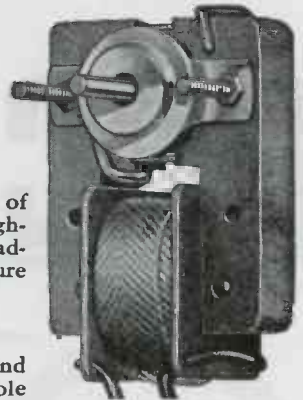

Model "MS"—Full Size Motor Measures 1 3/4" x 2 x 3 1/8"

EFFICIENT

Both the new Model "K" Motor and the Model "MS" are the shaded pole induction type—the last word in efficient small motor design. They can be produced in all standard voltages and frequencies with actual measured power outputs ranging upwards to 1/100 H. P. . . Alliance motors also can be furnished, in quantity, with variations to adapt them to specific applications.



New Model "K"—Full Size Motor Measures 2 1/8" x 2 3/8" x 3 1/8"

DEPENDABLE

Both these models uphold the Alliance reputation for all 'round dependability. In the busy post-war period, there will be many "spots" where these Miniature Power Plants will fit requirements . . . Write now for further information.

Remember Alliance!

—YOUR ALLY IN WAR AS IN PEACE

ALLIANCE MANUFACTURING CO.

ALLIANCE . OHIO

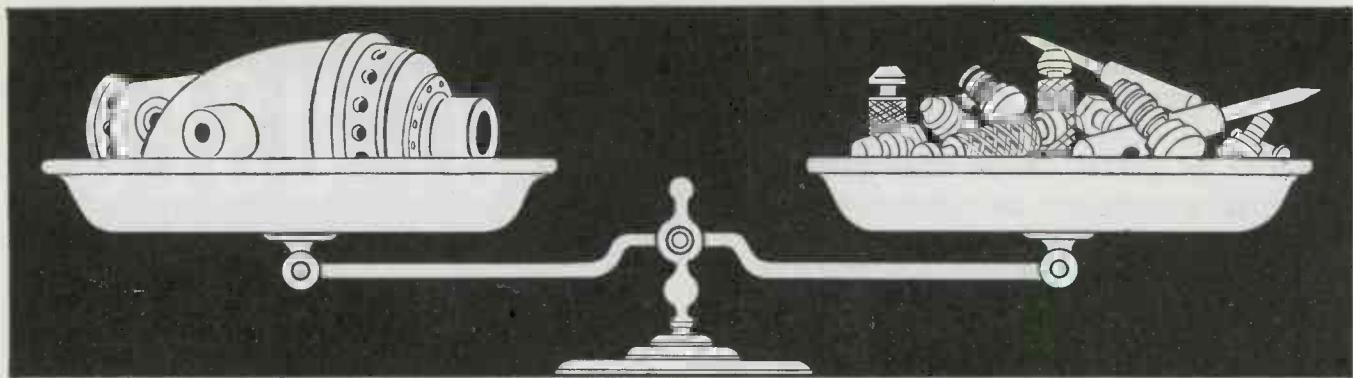

Matching Quality with Quality

As a "completer" of other people's products, we obligate ourselves to match quality with quality, so that functionally these products may be in even *balance* when assembled. Because of this interpretation of our job, we have over the years been privileged to "balance out" millions of manufactured articles with Peck Springs and Screw Machine Products. Because of this, also, our plant is incessantly busy with war work. However, old runs must be replaced with new ones; so, if you need springs up to 1/8" wire size and screw machine products up to 1 1/4", we would be pleased to receive an opportunity to submit quotations.

PECK SPRINGS and SCREW MACHINE PRODUCTS

The Peck Spring Company, 20 Grove Street, Plainville, Conn., U. S. A.

Precision CENTERED EYE Bending

With DI-ACRO BENDERS

DI-ACRO Precision Bending is accurate to .001" for duplicated parts. DI-ACRO Benders bend angle, channel, rod, tubing, wire, moulding, strip stock, etc. Machines are easily adjustable for simple, compound and reverse bends of varying radii.

Send for CATALOG

"DIE-LESS" DUPLICATING showing many kinds of "Die-less" duplicating produced with DI-ACRO Benders, Brakes and Shears.

← Pronounced "DIE-ACK-RO"

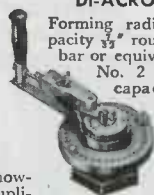

DI-ACRO Bender No. 1

Forming radius 2" approx. Capacity 3/8" round cold rolled steel bar or equivalent. Also Benders No. 2 and 3 with larger capacities.



O'NEIL-IRWIN MFG. CO.

348 EIGHTH AVE. SOUTH • MINNEAPOLIS 15, MINN.

TERMINALS
for
ELECTRIC WIRES

SMALL METAL STAMPINGS
in accordance with your blueprints

PRECISION PARTS
from Modern Equipment

PATTON-MacGUYER CO.
17 VIRGINIA AVENUE PROVIDENCE 5, R. I.

OPPORTUNITIES
in
Present and Postwar Work

Senior and Junior graduate Engineers with one or more years radio experience wanted by an expanding manufacturing division of an established Communication Company. Also, Engineers with practical experience for radio communication plant installation and test in foreign countries. Phone, call or write stating experience, education, present salary, etc., to:

PRESS WIRELESS, INC.
HICKSVILLE, L. I.
ATT: S. A. BARONE, CHIEF MFG. ENGR.

imperfections due to a myriad of causes. Thus in the interest of safety, simplicity and economy, it has occurred to me that there should be established about the earth a network of radio beacons which would be definitely related to latitude and longitude, so that only secondary reliance need be placed on the shifting and irregular field of the earth's magnetism. The advantages of such global radio beacons would be:

1) A position indicating system equally available to aircraft, surface vessels, explorers, surveyors, prospectors, etc.

2) A step forward in international harmony.

3) Economy:

31) In the allocation of frequency channels for navigational aids.

32) Standardization of radio beacon equipment.

33) Standardization of radio navigational equipment.

4) Instrumentation:

41) By elaborating on present radio compass equipment, there could be made available a continuous indication of Drift and Direction of an ocean vessel or an aircraft in flight.

42) Instrument indication would be instantaneous.

43) Electronic instrumentation is the answer to the ever increasing rapidity of flight.

To the extent that the foregoing proposal is sound, it is also urgent since the radio spectrum is in the process of being reallocated. Comments are solicited.—George D. Craig, II, 134-14 Franklin Ave., Flushing, N. Y.

Webster-Chicago Corp. Acquires Webster Products

Webster-Chicago Corp., 5622 Bloomingdale Avenue, Chicago, has purchased Webster Products, 3825 West Armitage Avenue, Chicago. The latter firm was, before the war, one of the largest manufacturers of automatic phonograph record changers. The former Webster Products organization and facilities will be retained intact and will operate as the Electronics Division of Webster-Chicago Corp.

The Electronics Division is now manufacturing dynamotors and voltage regulators for the war program. For peacetime production the new division will resume manufacture of Webster record changers. The Bloomingdale plant of Webster-Chicago will continue to specialize in the design and fabrication of laminations for motors and transformers primarily for the radio industry.



It's FREE! It's NEW!

CONCORD

BUYING-GUIDE
and **REVISED LISTINGS**

Radio
Parts

HUNDREDS
OF PARTS LIKE THESE
—Many Available
Without Priority

Just published! Concord's great, new 68-page Buying-Guide and latest 1945 Revised Listings of standard lines of Condensers, Transformers, Resistors, Tubes, Test Equipment, Repair and Replacement Parts, Tools, and hundreds of other essential items. Page after page of top-quality radio and electronic parts, and a special 16-page Bargain Section offering hundreds of hard-to-get parts at important savings. Mail the coupon now for your FREE copy. Use it to get what you need—and get it fast—from Concord.

Quick Shipment from CONCORD-CHICAGO or ATLANTA

Concord carries vast stocks. Concord ships to you *at once* from the nearest shipping warehouse, CHICAGO or ATLANTA. Concord invites you to consult our technical experts on special requirements. Concord can expedite any "essential" order and speed action. Concord now serves the United States Government, Institutions, Industry—and can serve YOU, whether you want one part or a hundred. Telephone, wire, or write your needs. And rush this coupon for the new 68-page Buying-Guide. It's FREE.

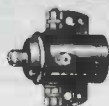

AUTO-LITE RELAY

Solenoid relay similar to relays on autos with push-button starters. 8.5 to 14 volts D.C., with heavy double make contacts. 3 3/8" x 3 3/8" x 2 1/4". A14516. Specially priced, **\$1.19**



MIDGET POWER TRANSFORMER

Pri. 117 volts, 60 cycles. Secondary 6.3 volts @ .5 amps., 150 volts @ 150 M. A., 50 volts @ 65 M. A. Size 3 1/4" x 3" x 2 1/2". A5959. Your cost, **98c**



6" PM SPEAKER

Ideal for AC-DC radios, P. A., and Intercom placements. 5 8 7 0 0 0. Your cost, **\$1.98**



TAPPED RESISTOR

Vitreous resistor, 90 watts, 6.4 ohms resistance tapped in 20 steps of .32 ohms ea. 5B197. Your cost, each, **89c**



HOOK-UP WIRE

20 solid rubber covered. Red or yellow. 100-ft. coils. Specify color. Your cost, each, **49c**



KURMAN RELAY

Type 223C34, S.P.D.T. contacts. 2.5 v. D.C., 8 MA, 300 ohm coil. 5B4020. Specially priced, **\$2.50**



AUDIO REACTOR

Sealed. .15 Hy at O. D.C. current. Con 2" x 2" x 2 1/2" with 4 1/2 mtg. inserts. 5 B 5 0 T 0. Your cost, **\$2.95**

CONCORD RADIO CORP.

Lafayette Radio Corporation

CHICAGO 7, ILL.
901 W. Jackson Blvd.

ATLANTA 3, GA.
265 Peachtree Street

Mail Coupon Today for FREE BOOK!

Concord Radio Corp.
901 W. Jackson Blvd., Dept. J-45
Chicago 7, Illinois
Please RUSH FREE copy of CONCORD'S new 68-page Buying-Guide and Revised Listings, just off the press.



Name _____
Address _____
City _____ State _____

NON-CORROSIVE

Screw Machine Parts

MADE TO CLOSE TOLERANCES

DO your assemblies call for non-corrosive fastening devices or screw machine parts made to close tolerances? All-metal has the "know how" and facilities to make such items accurately and economically, and to deliver them promptly. We have equipment for tapping, slotting, reaming, turning, stamping, broaching, drilling, threading and centerless grinding . . . and we work not only with stainless steel, but with monel, everdur, duralumin, brass, or other non-corrosive alloys. Write, wire or 'phone for our quotation.

Allmetal Screw Products Co.
80 Grand St., New York 13, N. Y.

Send for
FREE CATALOG

This new, 83-page catalog helps you select the correct size and type of non-corrosive fastening device for any particular job. Includes stock sizes, typical specials, engineering data, etc. Make request on company letter-head, please. Write to Dept. D

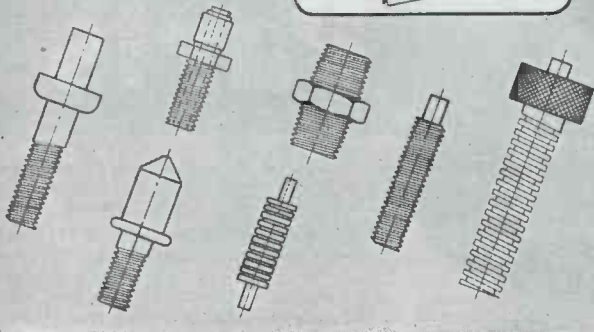

Kahle

ENGINEERING COMPANY
ELECTRON TUBE MACHINERY

All types, standard and special design.

Specialists in equipment and methods for the manufacture of:

- | | |
|--------------------|----------------|
| RADIO TUBES | NEON TUBES |
| CATHODE RAY TUBES | PHOTO CELLS |
| FLUORESCENT LAMPS | X-RAY TUBES |
| INCANDESCENT LAMPS | GLASS PRODUCTS |

On Production or Laboratory basis

1307-1315 SEVENTH ST., NORTH BERGEN, N. J., U. S. A.



Continuously Since 1930

PRECISION GROUND

Crystals

BY
HIPOWER

AIRCRAFT
MARINE • BROADCAST
POLICE • COMMERCIAL • AMATEUR

HIPOWER CRYSTAL COMPANY
Sales Division — 205 W. Wacker Drive, Chicago 6
Factory — 2033 Charleston St., Chicago 47, Ill.

EISLER EQUIPMENT

... the plus factor in tube manufacture



CHAS. EISLER specialized facilities are supplying high-efficiency manual, automatic and semi-automatic machinery for vacuum tube and electronic component production. Hundreds of devices are included — glass tube slicers, stem and sealing machines, flaring units, laboratory apparatus, etc.



- (A) No. 161-WH Glass Tube Constriction Forming Machine draws, rapidly, automatically.
- (B) No. 16 - 2S Two - Head Bench Type Flare Machine. Capable of rapid, efficient production. Simple operation.
- (C) No. 23-12LD, new type 12 head giant Tipless Stem Machine.
- (D) No. 11-TU Glass Tube Slicer, makes clean, sharp cuts—does not require skill.
- (E) No. 57-X Laboratory Unit for glass cutting, flaring, stem making, sealing-in, exhausting, basing.

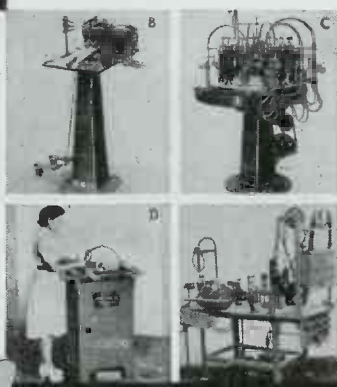

ENGINEERING COMPANY

778 SO. 13th STREET, NEWARK 3, N. J.

WANTED

ELECTRONIC AND AUDIO ENGINEER

For key position in a small but nationally known concern with unusual post-war possibilities. Liberal salary and chance for advancement. Qualifications: E. E. degree with practical experience in design of radios, amplifiers, and electro-acoustic equipment. Address Box No. 4537, Electronic Industries, 480 Lexington Ave., New York 17, New York, for confidential interview, stating qualifications, experience, any patents, or personal background.

RADIO DEVELOPMENT ENGINEER

Large company with good post-war prospects seeks man with at least five years' experience in the design and development of automobile radio receivers. Salary \$4,500.

BOX 4597

ELECTRONIC INDUSTRIES
480 Lexington Ave., New York 17, N. Y.

ELECTRONIC INDUSTRIES

Advertisers—April, 1945

Page	Page	Page
Ace Mfg. Corp.194	Electro Motive Mfg. Co. 31	North American Philips Co., Inc.187
Aerovox Corp. 33	Electronic Engineering Co.178	Ohmite Mfg. Co.211
Albion Coil Co. 14	Electronic Enterprises, Inc.153	O'Neil-Irwin Mfg. Co.236
Alden Products Co. 20	Electronic Mechanics, Inc. 47	Panoramic Radio Corp.217
Alliance Mfg. Co.235	Electronic Products Mfg. Corp.200	Par-Metal Products Corp.234
Allied Control Co., Inc. 69	Electro-Voice Corp.209	Patton-MacGuyre Co.236
Allied Radio Corp.166	Emerson Radio of Washington.192	Peck Spring Co.236
Allmetal Screw Products Co.238	Erie Resistor Corp.131	Peerless Electrical Products Co.206
Altec Lansing Corp.198	Federal Telephone & Radio Corp.126, 185	Permolux Corp.152
Aluminum Co. of America.161	Fenwal, Inc.240	Philco Corp. 6
American Electrical Heater Co.234	Finch Telecommunications, Inc.117	Pioneer Gen-E-Motor Corp.136
American Lava Corp. 73	Formica Insulation Co.175	Premier Metal Etching Co.220
American Transformer Co.157	Foster Co., A. P. 12	Press Wireless, Inc.236
Amperex Electronic Corp. 2	General Ceramics & Steatite Corp.149	Presto Recording Corp. 60
Amperite Co.222	General Electric Co.5, 51, 70, 135, 223	Radell Corp.180
Andrew Co.154	General Industries Co.177	Radio Corporation of America: RCA Victor Division171
Ansonia Electrical Co. 8	General Instrument Corp.193	Radio Receptor Co., Inc.197
Arnold Engineering Co.170	Gothard Mfg. Co.178	Radio Specialties Co.231
Associated Research, Inc.210	Grayhill235	Radio Wire Television, Inc.204
Atlas Sound Corp.168	Groves Corp.168	Ray-O-Vac Co. 7
Audio Development Co.144	Guardian Electric Mfg. Co.119	Raytheon Mfg. Co.72, 221
Automatic Electric Sales Corp. 22	Hallicrafters Co. 38	Remler Co., Ltd. 30
Barker & Williamson142	Hamilton Institute, Alexander.224	Ritter Co., Inc.240
Bell Sound Systems, Inc.232	Hammarlund Mfg. Co., Inc. 50	Rola Co., Inc.147
Bell Telephone Laboratories. 18	Harvey Radio Co.216	Rothenstein, Albert 220
Bentley, Harris Mfg. Co.163	Harvey Radio Laboratories, Inc.191	Sangamo Electric Co.172, 173
Benwood Linze Co. 24	Haydon Mfg. Co., Inc.198	Schauer Machine Co.210
Bird & Co., Richard H.208	Heintz & Kaufman, Ltd. 68	Schweitzer Paper Co.159
Blaw-Knox Co. 21	Hickok Electrical Instrument Co.190	"S" Corrugated Quenched Gap Co.125
Biley Electric Co. 53	Hipower Crystal Co.238	Scovill Mfg. Co. 29
Brach Mfg. Corp., L. S.184	Hopp Press, Inc.232	Sentinel Radio Corp. 28
Bradley Laboratories, Inc. 61	Hovis Screwlock Co.129	Sherron Electronics Co.169
Breeze Corp., Inc. 37	Hunter Pressed Steel Co.165	Shure Brothers 34
Bridgeport Mfg. Co. 57	Hytron Radio and Electronic Corp.113	Sigma Instruments, Inc.186
Burgess Battery Co.134	Illinois Condenser Co.224	Simpson Electric Co. 52
Burstein-Applebee Co.240	Indiana Steel Products Co.128	Small Motors, Inc.214
Caldwell-Clements, Inc.188	Industrial Instruments, Inc.230	Snyder Mfg. Co.216
Cambridge Thermionic Corp.123	International Nickel Co., Inc. 26	Sola Electric Co.155
Capitol Radio Engineering Institute194	International Resistance Co. 65	Speer Carbon Co.195
Carter Motor Co.192	Irrington Varnish & Insulator Co.203	Spencer Thermostat Co. 56
Celanese Corp. of America.199	Jackson Electrical Instrument Co.138	Spencer Wire Co. 63
Centralab 64	J-B-T Instruments, Inc.196	Sperit, Inc.146
Chicago Telephone Supply Co. 41	Jefferson Electric Co.183	Sprague Electric Co. 66
Chicago Transformer, Div.160	Johnson Co., E. F.23, 218	Stackpole Carbon Co. 62
Essex Wire Corp.160	Jones Co., Howard B.208	Standard Transformer Corp.140
Cinema Engineering Co.240	Kaar Engineering Co.205	Struthers-Dunn, Inc.227
Clarostat Mfg. Co., Inc.214	Kahle Engineering Co.238	Stupakoff Ceramic & Mfg. Co.139
Cole Steel Equipment Co.13, 156	Karp Metal Products Co., Inc.132	Sun Radio & Electronics Co.226
Collins Radio Co.145	Keuffel & Esser Co.215	Superior Tube Co.179
Colonial Kolonite Co.224	Kinney Mfg. Co.174	Suprenant Electrical Insulator Co.208
Communication Products Co., Inc.143	Kurman Electric Co.235	Sylvania Electric Products, Inc. 16
Communications Co., Inc.148	Langevin Co. 44	Thomas & Skinner Steel Products Co.188
Conant Electrical Laboratories.150	Lapp Insulator Co., Inc.213	Triplet Electrical Instrument Co. 49
Concord Radio Corp.237	Lavoie Laboratories115	Turner Co. 15
Connecticut Telephone & Electric 54	Lectrohm, Inc.231	United Cinephone Corp.239
Connector Div., International Resistance Co. 9	Lord Mfg. Co.137	United Electronics Co.167
Consolidated Radio Products Co.164	Machlett Laboratories, Inc. 27	United Screw & Bolt Corp.121
Continental Electric Co. 35	MacRae's Blue Book231	United Transformer Corp. 74
Cornell-Dubilier Electric Corp. 19	Makepeace Co., D. E.130	Universal Microphone Co.219
Corning Glass Works127	Mallory & Co., Inc., P. R.17, 36	University Laboratories204
Corry-Jamestown Mfg. Corp. 71	Marion Electrical Instrument Co. 25	Utah Radio Products Co. 39
Creative Plastics Corp.212	Mec-Rad Division-Black Industries 55	Valpey Crystal Corp.176
Dalis, Inc., H. L.228	Merit Coil & Transformer Corp. 4	Walker-Jameson, Inc.231
Daven Co.Cover 3	Micamold Radio Corp.206	Wallace Mfg. Co., Wm. T.182
Dazor Mfg. Co. 58	Micro Switch Corp.124	Waltham Screw Co. 45
DeJure-Amsco Corp. 201	Millen Mfg. Co., Inc., James.202	Ward Leonard Electric Co. 46
Deutschmann Corp., Tobe 3	Miller Electric Co.240	Western Electric Co.10, 11, 226
Dial Light Co. of America, Inc.182	Monarch Mfg. Co.180	Westinghouse Electric & Mfg. Co.59, 141, 189, 207
Dolph Co., John C. 48	National Union Radio Corp. 67	Weston Electrical Instrument Corp.233
Drake Mfg. Co.222	National Vulcanized Fibre Co.151	Wheeler Insulated Wire Co., Inc. 32
Dumont Electric Co.200	New York Transformer Co.181	Whitaker Cable Corp. 43
DuMont Laboratories, Inc., Allen B.42, 133		Wiedemann Machine Co.225
Eby, Inc., Hugh H.228		Willor Mfg. Co.162
Ecor, Inc.158		Wilson Co., H. A.229
Eisler Engineering Co.238		
Eitel-McCullough, Inc. 40		
Electric Soldering Co., Inc.220		



YALE PHANTOM DOORMAN HELPS MAINTAIN ASEPSIS IN HOSPITALS WITH PHOTO-ELECTRIC CONTROL

The Electric Eye Door Opener is already widely in use in restaurants and other public buildings . . . In hospitals, where sanitation is of even more importance, it is still comparatively new. Located between major operating rooms and the doctors' scrub room it makes possible the automatic opening and closing of doors without touch of hands. These controls are the result of the merging of Yale and Towne's extensive knowledge of mechanical door devices with the Electronic engineering of United Cinephone Corporation. They can be set to operate within whatever interval of time is required between the opening and closing of the door.

OTHER APPLICATIONS of United Cinephone Electronic controls are almost without limit. If you have a problem of measuring, gauging, counting, sorting, heating, or some other operation in your plant, which is costly and unreliable, you will want to investigate the possibility of solving the problem ELECTRONICALLY. That's where our extensive experience and facilities in Electronic design, engineering, and manufacturing can be of invaluable help. Your inquiry will be welcome.

Electronic fields we cover include:

1. Industrial Controls
2. Aircraft Communications
3. Laboratory Test Equipment
4. Radio and Audio Equipment

UNITED CINEPHONE CORPORATION

28 NEW LITCHFIELD ST.
TORRINGTON, CONNECTICUT

While every precaution is taken to insure accuracy, we cannot guarantee against the possibility of an occasional change or omission in the preparation of this index.

MEMO:

*Too busy
this month, making
Variatens for the
war effort, to write
copy for ads.
Yours truly
Art Davis*

CINEMA ENGINEERING CO.
1508 W. VERDUGO AVE. • BURBANK, CALIF.

X - R A Y

Important Manufacturer of dental and medical
EQUIPMENT
expanding medical line, needs
ENGINEERS

with shop practice capable of designing and
developing new models of x-ray equipment
for medical profession. Permanent position
with excellent post-war future.

RITTER COMPANY, INC.
ROCHESTER 3, NEW YORK

**Harness
our ingenuity in
wiring technique to
your production
problems**

MILLER ELECTRIC CO.
Doing unusual things with wire for war
127 HIGH STREET • PAWTUCKET • R. I.



THERMOSWITCHES
... put tires in trim for extra mileage



Vulcanizing is playing a vital part in the conservation of precious rubber... and in controlling the temperature of tire vulcanizers, THERMOSWITCHES give unparalleled performance.

Write for catalogue and complete information... to
Fenwal INCORPORATED
ASHLAND • MASS.

SWEDEN

Successful firm established 1928 anxious to represent leading manufacturer of raw materials, semi-processed or components for Radio & Electrical field. Favorably known to large volume buyers. Immediate negotiation best for mutual benefits. Commission basis. Reply

BOX 4567, ELECTRONIC INDUSTRIES
480 Lexington Ave. New York 17, N. Y.

NATION-WIDE MAIL
ORDER DISTRIBUTORS
SINCE 1928

BA

RADIO AND ELECTRONIC
DEVICES For Trade... Industry... Vocational
... Communication... Public Utility and Experimental Applications

BURSTEIN-APPLEBEE CO.
1012-14 McGee St. Kansas City 6, Missouri

DAVEN

VOLUME LEVEL INDICATORS

DAVEN Volume Level Indicators are designed to indicate audio levels in broadcasting, sound recording and allied fields. Extremely sensitive, they are sturdily constructed and correctly damped for precise monitoring. The long, specialized experience of DAVEN in the design and development of test equipment makes these Indicators the preference of major sound engineers both here and abroad.

TYPE 920
 Rack model, low-level bridging type. Meter multiplier range: -20 VU to +20 VU. Power supply, 100-130 V, 60 cycle AC, with voltage regulator for normal variations. Reference level: 1 mw into 600 ohms.



TYPE 911
 Portable model, bridging type. Meter multiplier range: +4 VU to +42 VU or +4 VU to +26 VU, 2 VU steps. Reference level: 1mw into 600 ohms.



TYPE 910
 Rack model, same as Type 911.

TYPE 915
 Rack model, terminating and bridging type. Meter multiplier ranges: terminating, -6 VU to +32 VU; bridging, +4 VU to +42 VU; or terminating, -6 VU to +16 VU; bridging, +4 VU to +26 VU. 2 VU steps. Reference level: 1 mw into 600 ohms.



GENERAL SPECIFICATIONS

INPUT IMPEDANCE: Bridging, 7500 ohms; terminating, 600 ohms, excepting Type 185—1581 ohms, bridging.

FREQUENCY RANGE: Less than 0.2 db up to 10,000 c.p.s. Type 920, less than 0.2 db, 33 up to 15,000 c.p.s.

METER SCALE: -20 to +3 VU and 0 to 100%. Type A scale has VU reading on upper scale; Type B scale has percentage reading on upper scale.

INDICATING METER: Copper-Oxide type, adjusted for deliberate pointer action.

METER ADJUSTMENT CONTROL: Miniature step type; +0.5 db range, in 0.1 db steps.

MOUNTING: Rack models 19" long for standard relay rack, portable models in walnut cabinet, approx. 11"x6"x6 1/4".



TYPE 185
 Power Level Indicator, portable or rack model, bridging type. Meter multiplier range: -10 db to +46 db. Reference level: 6 mw into 500 ohms.

THE **DAVEN** COMPANY
 191 CENTRAL AVENUE
 NEWARK 4, NEW JERSEY

HELP SPEED TOTAL VICTORY, BUY AND HOLD MORE WAR BONDS

How to Lower Your Tube Costs



Simply base your designs on RCA Preferred-Type Tubes which, in a single year, dropped more than 13% in price.

Not only have prices been lowered by the Preferred-Type Program but the quality of the tubes has been improved, due to longer production runs and increased skill of workers.

How the preferred-type idea started

Long before Pearl Harbor, RCA found that despite the hundreds of different receiving-tube types being manufactured, almost every possible circuit requirement could be satisfied by a list of less than 50 tube types.

Moreover, by limiting the number of types being manufactured, it would be possible to realize tremendous savings in warehousing, distribution, test equipment, and other factors affecting cost.

The plan was promoted among equipment designers who, quick to see the advantages of fewer tube types, cooperated wholeheartedly to make the Preferred-Type Program a success.

When the war broke out, the Army and Navy adopted the Preferred-Type idea and established a list of their own, including many tubes already on RCA's Preferred-Type list. Military equipment was designed almost exclusively around Army-Navy Preferred-Type Tubes. This forward-looking policy simplified military tube stocks and insured speedy replacements on the fighting fronts.



Which RCA tubes are preferred types

By substantial indication of preference, designers themselves — not RCA — determine which tubes are Preferred Types.

Because the list of Preferred Types (metal, miniature and glass) is still rather fluid, it is advisable to check with us before your final decisions are made regarding any specific tube. Write to Department 62-28J, RCA, Harrison, N. J.



The fountain-head of modern Tube development is RCA.



62-8136-28

RADIO CORPORATION OF AMERICA

RCA VICTOR DIVISION • CAMDEN, N. J.